

trēo proTM by palm
smartphone

User Guide

Intellectual property notices

© 2008 Palm, Inc. All rights reserved. Trademark, copyright, patent, and other intellectual property notices are set forth within the safety and legal information included in your smartphone package.

This product is protected by certain intellectual property rights of Microsoft Corporation. Use or distribution of such technology outside of this product is prohibited without a license from Microsoft or an authorized Microsoft subsidiary. All rights reserved.

Disclaimer and limitation of liability

Palm Inc. and its suppliers assume no responsibility for any damage or loss resulting from the use of this guide. Palm Inc. and its suppliers assume no responsibility for any loss or claims by third parties that may arise through the use of this software. Palm Inc. and its suppliers assume no responsibility for any damage or loss caused by deletion of data as a result of malfunction, dead battery, or repairs. Be sure to make backup copies of all important data on other media to protect against data loss.

This product is protected by one or more of the following United States patents:

7,007,239; 6,976,226; 6,975,304; 6,965,375; 6,961,567;
6,961,029; 6,957,397; 6,952,571; 6,950,988; 6,947,975;
6,947,017; 6,943,667; 6,940,490; 6,924,752; 6,907,233;
6,906,701; 6,906,741; 6,901,276; 6,850,780; 6,845,408;
6,842,628; 6,842,335; 6,831,662; 6,819,552; 6,804,699;
6,795,710; 6,788,285; 6,781,824; 6,781,575; 6,766,490;
6,745,047; 6,744,451; 6,738,852; 6,732,105; 6,724,720;
6,721,892; 6,712,638; 6,708,280; 6,697,639; 6,687,839;
6,685,328; 6,665,803; 6,618,044; 6,590,588; 6,539,476;
6,532,148; 6,523,124; 6,519,141; 6,516,202; 6,490,155;
6,480,146; 6,457,134; 6,456,247; 6,442,637; 6,441,824;
6,437,543; 6,429,625; 6,425,087; 6,389,572; 6,388,877;
6,381,650; 6,363,082; 6,344,848; 6,317,085; 6,241,537;
6,222,857; 6,185,423; 6,147,314; 6,115,248; 6,064,342; 7,356,361;
D421,251; D429,252; D466,128; D478,091. Patent pending.

This product also is licensed under United States patent 6,058,304.

Palm Take Back and Recycling Program



This symbol indicates that Palm products should be recycled and not be disposed of in unsorted municipal waste. Palm products should be sent to a facility that properly recycles electrical and electronic equipment. For information on environmental programs visit palm.com/environment.

As part of Palm's corporate commitment to be a good steward of the environment, we strive to use environmentally friendly materials, reduce waste, and develop the highest standards in electronics recycling. Our recycling program keeps Palm handheld devices, smartphones, and mobile companions out of landfills through evaluation and disposition for reuse and recycling.

Palm customers may participate in the recycling program free of charge. Visit palm.com/recycle for additional details and information about how you can help reduce electronic waste.

v. 1.0

Contents

Chapter 1: Welcome	9
Your Palm® Treo™ Pro smartphone	11
What's in the box?	11
What do I need to get started?	12
Where can I learn more?	13
Chapter 2: Setting up	15
Palm® Treo™ Pro smartphone overview	17
Inserting the SIM card and battery	19
Charging the battery	21
Making your first call	24
Using the My Treo application	26
Setting up synchronization	26
Chapter 3: Moving around on your smartphone	27
Navigating around the screen	29
Using the keyboard	35
Opening and closing applications	39
Using your Today screen	42
Chapter 4: Your phone	45
Turning your smartphone on/off	47
Making calls	49
Receiving calls	53
Using voicemail	54
What can I do during a call?	55
Working with called numbers	61
Assigning a speed dial to a phone number	63

What are all those icons?	65
Using a phone headset	68
Customizing phone settings	72
Chapter 5: Synchronizing information	83
Synchronization overview	85
How do I synchronize?	85
What can I synchronize?	86
Setting up your computer for synchronization	89
Synchronizing using the USB cable	94
Setting up wireless synchronization	95
Other ways to synchronize	100
Changing which applications sync	102
Stopping synchronization	103
Chapter 6: Your email	105
Setting up email	107
Sending and receiving messages	115
Working with email messages	120
Customizing your email settings	126
Working with meeting invitations	134
Sending email messages from within another application	135
Chapter 7: Your text and multimedia messages	137
Sending and receiving text and multimedia messages	139
Setting message preferences	152
Using Windows Live™	155
Chapter 8: Your connections to the web and wireless devices	161
Browsing the web	163
Working with streaming content	170
Getting online travel information and tools	172

Determining your GPS location	173
Connecting to a Wi-Fi network	174
Connecting to devices with Bluetooth® wireless technology	183
Using your device as a wireless modem	187
Chapter 9: Your photos, videos, and music	191
Synchronizing your pictures, videos, and music	193
Camera	195
Pictures & Videos	202
Windows Media Player Mobile	208
Chapter 10: Your personal information organizer	215
Contacts	217
Calendar	222
Tasks	228
Notes	231
Chapter 11: Your Microsoft Office and other document tools	235
Synchronizing your Microsoft Office files	237
Word Mobile®	239
PowerPoint Mobile®	246
Excel Mobile®	247
OneNote Mobile	258
Adobe® Reader® LE	261
Chapter 12: Your application and info management tools	265
Finding information	267
Installing applications	269
Removing applications	272
Sharing information	273
Beaming information	274

Using expansion cards	276
Accessing information on a remote computer	281
Calculator	282
Chapter 13: Your personal settings	285
Today screen settings	287
System sound settings	288
Display and appearance settings	290
Application settings	292
Locking your smartphone and info	297
System settings	302
Connection settings	309
Chapter 14: Troubleshooting	313
Transferring info from another device	315
Reinstalling the desktop software	315
Resetting your smartphone	316
Performance	319
Screen	320
Network connection	321
Synchronization	325
Email	332
Web	335
Camera	336
Third-party applications	337
Making room on your smartphone	338
Voice quality	338
Terms	341
Regulatory and safety information	347

Specifications	359
Index	363



Welcome

Congratulations on the purchase of your Palm® Treo™ Pro smartphone.

Benefits

- Make and receive phone calls
- Manage your contacts, calendar, and task list
- Receive and send corporate and personal email messages
- Browse the web
- Use a Bluetooth® headset (sold separately) for hands-free operation

In this chapter

Your Palm® Treo™ Pro smartphone	11
What's in the box?	11
What do I need to get started?	12
Where can I learn more?	13

Your Palm® Treo™ Pro smartphone

In one compact and indispensable device, you now have all of the following:

- An advanced wireless smartphone
- A full suite of Windows Mobile® organizer applications: Contacts, Calendar, Notes, and Tasks
- Portable expansion capability (microSD or MMCmicro cards, sold separately)
- High-speed data with GPRS/EDGE and UMTS (3G and HSDPA) support
- Wi-Fi capability
- A 2-megapixel digital camera
- GPS functionality
- Support for numerous mobile email solutions
- Text and multimedia messaging
- Windows Media® Player Mobile
- Microsoft Office Mobile® suite

This guide helps you set up your smartphone and learn to use it.

TIP LOOK HERE: Don't miss the helpful tips and cross-references given in these boxes.

What's in the box?

All of the following items should be in the smartphone box:

Hardware

- Treo Pro smartphone
- Rechargeable battery (1500 mAh)
- USB AC charger (with international adapters in some smartphone packages)
- USB cable
- Stereo headset

Documentation and software

- *Getting Started*, information on how to set up and begin to use your smartphone
- Palm warranty
- Safety and legal information

Your smartphone contains links to the following:

- Desktop synchronization software (ActiveSync® desktop software for Windows XP computers, Windows Mobile Device Center for Windows Vista™ computers)
- *User Guide* (this guide) on the web
- Microsoft Office Outlook® 2007 software trial download

What do I need to get started?

As you work through the instructions in this guide, you need all the items that came in the smartphone box (see [What's in the box?](#)).

In addition, depending on how you want to use your smartphone, here's what you need to get from your wireless service provider:

Service contract with an activated SIM

card: For making and receiving calls, and sending and receiving text messages.

Data service plan: For web browsing and email.

Additional data services: These may be required to send and receive multimedia messages. Check with your wireless service provider for information.

TIP When you sign up for data services with your wireless service provider, be sure to discuss what charges you incur if you go over the stated limit on your data plan.

After you have the required plan and services, you must have your smartphone within range of your wireless service provider's cellular coverage to use the phone, messaging, and web features. Data speeds vary based on network availability and capacity.

Finally, if you plan to synchronize personal information between your smartphone and a computer, you need access to that computer during setup.

Where can I learn more?

For a quick introduction

- **Quick Tour:** The Quick Tour introduces you to many of your smartphone's features. It is already installed on your smartphone, and you can open it from your Today screen by selecting **Quick Tour**.

TIP If you remove the Quick Tour entry from your Today screen (see [Using your Today screen](#)), you can always open the Quick Tour by pressing **Start**, selecting **Programs**, and then selecting **Quick Tour**.

While using your smartphone

- **On-device Help:** Your smartphone includes on-device Help that is specially formatted for your smartphone screen. To view the on-device help, press **Start**  and select **Help**.

- **Online support from Palm:** For up-to-date downloads, troubleshooting, and support information, go to palm.com/treoproumts-support.

If you need more information

- **Books:** Many books on Windows Mobile devices are available from local or online book retailers (look in the computer section).
- **Customer service from** your wireless service provider: For questions about your mobile account or features, contact your wireless service provider's customer care.



Setting up

You're about to discover the many things about your smartphone that will help you better manage your life and have fun, too.

As you become more familiar with your smartphone, you'll want to personalize the settings and add applications to make it uniquely yours. But first, follow these few easy steps to set up your smartphone and get it running.

Benefits

- Know where your smartphone controls are located
- Start using your smartphone right away

In this chapter

Palm® Treo™ Pro smartphone overview	17
Inserting the SIM card and battery.	19
Charging the battery.	21
Making your first call	24
Using the My Treo application	26
Setting up synchronization	26

Palm® Treo™ Pro smartphone overview

Front view

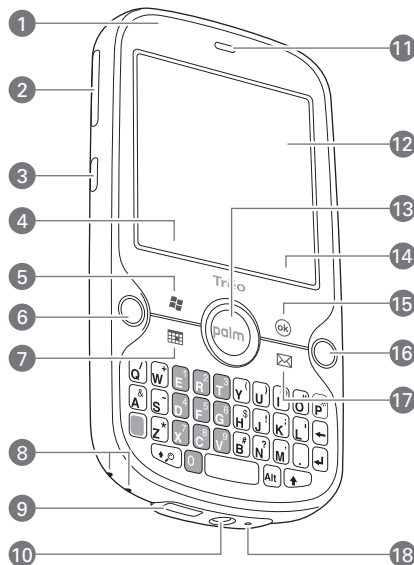

- 1 Charge indicator light (visible when smartphone is being charged)
- 2 Volume

- 3 Side button
- 4 Left softkey
- 5 Start
- 6 Phone/Send
- 7 Calendar
- 8 Lanyard connector
- 9 MicroUSB connector (sync and power connector)
- 10 3.5mm stereo headset jack
- 11 Earpiece
- 12 Touchscreen
- 13 5-way navigator with Center button
- 14 Right softkey
- 15 OK
- 16 End
- 17 Messaging
- 18 Microphone

TIP Be careful not to scratch or crush your smartphone screen. Do not store it in a place where other items might damage it.

DID YOU KNOW? By default, pressing and holding the Side button opens Camera (see [Camera](#)). You can change the function of the Side button (see [Reassigning buttons](#)).

IMPORTANT The smartphone speaker includes a large magnet, so be sure not to store your smartphone near credit cards or other items that could be demagnetized.

Back view

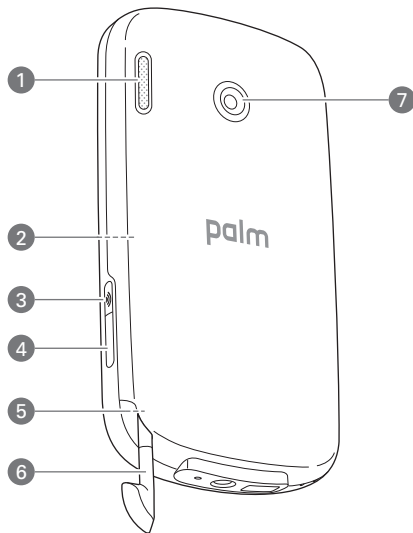

- 1 Speaker
- 2 Expansion card (microSD) slot (under back panel)

- 3 Wi-Fi
- 4 IR (infrared) port
- 5 Reset button (under back panel)
- 6 Stylus
- 7 Camera lens

DID YOU KNOW? To save power, when your smartphone screen turns off, the Wi-Fi feature turns off. Press **Wi-Fi** to turn this feature back on and quickly reconnect to a network. You can also set an option to leave the Wi-Fi feature on (see [Customizing Wi-Fi settings](#)).

TIP To connect a lanyard (sold separately), remove the back panel, connect the lanyard, and replace the back panel.

Top view

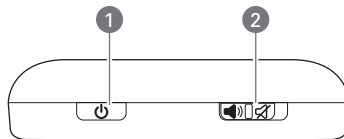

- 1 Power
- 2 Ringer switch (slide to turn off all sounds immediately)

Inserting the SIM card and battery

WARNING Use only batteries and chargers that are approved by your wireless service provider or Palm with your smartphone. Failure to use an approved battery or charger may increase the risk of your smartphone overheating, catching fire, or exploding, which may result in serious bodily injury, death, or property damage. Failure to use an approved battery or charger may also prevent your smartphone from turning on or charging and may void your smartphone warranty.

Your SIM card contains account information such as your phone number and voicemail access number. To use your smartphone's phone, email, or web features, you need to insert a SIM card.

If you don't have a SIM card, contact your wireless service provider.

To take advantage of the high-speed data connection available on your smartphone, you may need to have a 3G SIM card.

Check with your wireless service provider for information.

IMPORTANT Your smartphone responds only after you complete these steps. After the screen wakes up the first time, you can turn it on and off by pressing **Power** .

- 1 With the back panel facing you, press the lower-right corner of the back panel with your right thumb to release the panel. Remove the panel.



- 2 If the battery is installed, remove it. Slide your finger under the top of the battery (nearest the camera lens) and lift up.
- 3 Hold the SIM card with its metal contacts facedown and its notch aligned with the notch of the cutout in the compartment, and slide the SIM card into the cutout.

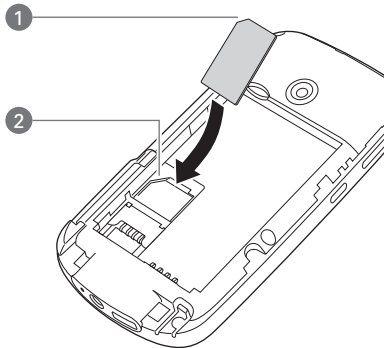

- 1 Card notch
- 2 Compartment notch

- 4 Align the metal contacts on the battery with the contacts of the battery compartment, and then press the battery into place.

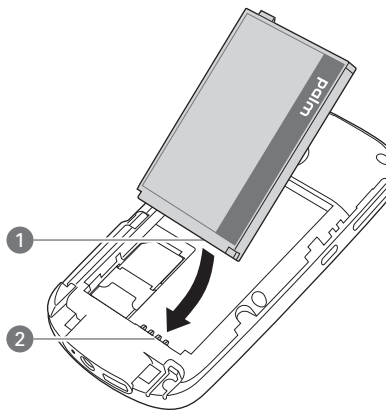

- 1 Battery contacts
- 2 Smartphone contacts

- 5 Slide the back panel back into place. Your smartphone screen turns on. It takes a few minutes for your smartphone to prepare for setup—you'll see the Palm® logo and a blank

Windows Mobile screen. You are ready to begin setup when text appears prompting you to tap the screen.

TIP If your smartphone does not turn on after you insert the battery, you need to connect it to the USB AC charger to charge it (see [Charging the battery](#)). If it still doesn't start, perform a soft reset (see [Performing a soft reset](#)).

- 6 Follow the onscreen instructions to finish the installation. If prompted, tap **Reboot** to complete setup.
- 7 If your SIM card is not already activated, follow the activation steps provided by your wireless service provider, or contact your wireless service provider directly for assistance.

Charging the battery

Although the battery may come with a sufficient charge to complete the setup process, we recommend that after setup you charge your smartphone until the indicator light is solid green to give it a full charge.

See [Maximizing battery life](#) for tips on making your battery's power last longer.

BEFORE YOU BEGIN Make sure the battery is correctly inserted in your smartphone.

- 1 If you have international adapters in your smartphone package, prepare the USB AC charger by inserting the adapter that fits the wall outlet you're going to use.
- 2 Plug the USB AC charger into a wall outlet.
- 3 Connect the charger cable to the bottom of your smartphone.

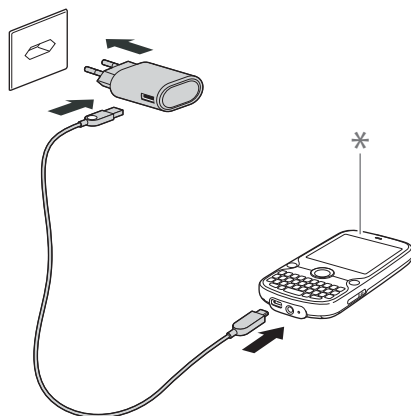

* Indicator light





- 4 Check the indicator light to confirm that your smartphone is being charged.

Solid red: Your smartphone is being charged.

Solid green: Your smartphone is fully charged.

TIP You can also charge your smartphone battery by connecting your smartphone to your computer using the USB cable. Charging this way takes much more time than using the USB AC charger.

When your smartphone is on (see [Turning your smartphone on/off](#)), the onscreen battery icon on the Today screen displays the charging status:

-  Solid lightning bolt: The battery is being charged.
-  Filled battery: The battery is fully charged and can be disconnected from the charging source.
-  Partly filled battery: The shading indicates approximately how much power the battery has.
-  Exclamation point: Charge the battery immediately.

DID YOU KNOW? If the battery is low, the indicator light flashes red.

TIP Tap the **battery** icon to see how much power the battery has.

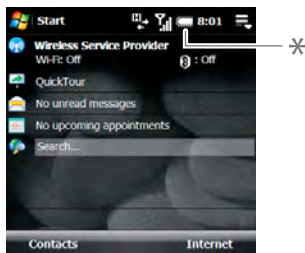

* Battery icon

TIP To go to the Today screen so you can view the battery icon, press **End** if you are not on a phone call. If you're on a call, press **Start** and select **Today**.

Maximizing battery life

Battery life depends on how you use your smartphone. You can maximize the life of your battery by following a few easy guidelines:

- If you set up an email account in the Messaging application, set the interval to automatically download email to every two hours or less frequently (see [Setting up email](#)).
- Turn off the Wi-Fi feature (see [Turning wireless services on/off](#)), leave the default option to connect only when the Wi-Fi button is pressed, or adjust Power Save Mode to maximize the battery (see [Customizing Wi-Fi settings](#)).
- Turn off the Bluetooth feature if you're not using it (see [Entering basic Bluetooth settings](#)).
- Turn off the option to receive beamed information if you're not using it (see [Turning on the option to receive beamed information](#)).
- Set your screen to turn off automatically after a shorter period of inactivity (see [Optimizing power settings](#)).
- As with any mobile phone, if you are in an area with no wireless coverage, your smartphone nevertheless continues to search for a signal, which consumes power. Turn off your phone if you are outside a coverage area (see [Turning your phone off](#)). You can forward calls to a different number or let all calls be picked up by voicemail (see [Forwarding calls](#)).

- Turn off the voice command feature if you're not using it (see [Setting up voice commands](#)).
- Turn down the screen brightness (see [Adjusting the brightness](#)).
- If you synchronize with your corporate Exchange server using Microsoft Exchange ActiveSync®, increase the time interval between automatic synchronizations (see [Setting the synchronization schedule](#)).
- Keep your battery away from direct sunlight and other sources of heat. Temperatures over 50 degrees Celsius (120 degrees Fahrenheit) can permanently reduce the capacity and life span of any lithium-ion battery.

Making your first call

- 1 Press **End**  to display your Today screen.

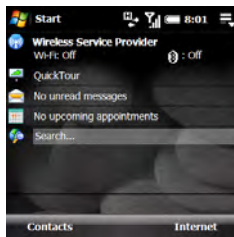

- 2 Press **Center**  to turn off **Keyguard** (see [Locking your keyboard \(Keyguard\)](#) for more info).
- 3 Use the number keys to enter the number you want to call.

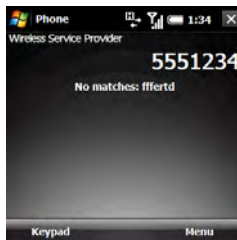

- 4 Press **Phone/Send**  to dial.
- 5 Press **End**  to end the call.

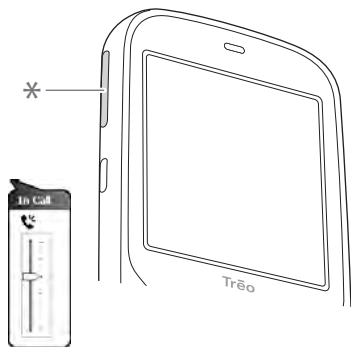

Adjusting call volume

When you're on a call, press the **Volume** button on the side of your smartphone to adjust the call volume.



* Volume

What's my number?

- 1 Make sure your phone is on (see [Turning your phone on](#)).
- 2 Press **Start**  and select **Programs**.
- 3 Select **SIM Manager** .

- 4 Look for your phone number directly below the title bar.

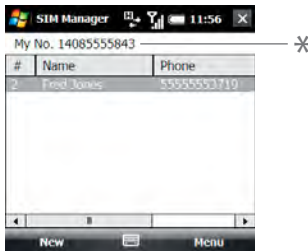

* Look here for your phone number

- 5 Press **OK** .

TIP If your phone number doesn't appear on the Phone Settings screen, your network has not yet sent the number to the SIM card (this does not affect SIM card functionality). Turn your phone off, wait a few hours, and then turn on your phone and repeat these steps. If your phone number still does not appear, contact your wireless service provider for assistance.

Using the My Treo application

Use the My Treo application to register your smartphone and access the *User Guide* and online support. My Treo also provides an alternate starting point for setting up an email account, a Bluetooth® connection, or a Wi-Fi connection, and for launching the Quick Tour.

- Press **Start**  and select **My Treo**.

Setting up synchronization

After you've finished setting up your smartphone, we recommend that you set up a synchronization method to get the most out of your smartphone.

Synchronizing means that information that you enter or update in one place—your smartphone, your computer, or your corporate server—is automatically updated in the other (see [Synchronizing information](#)).



Moving around on your smartphone

Have you ever been to a new city and felt a bit lost until you figured out the streets? Learning to move around on your Palm® Treo™ Pro smartphone is a similar experience. Most applications that work on your smartphone use the same set of controls. So once you learn how to use these controls, you'll be driving all over town and you won't even need a map.

Benefits

- Quickly move around and complete tasks in applications using one thumb on the 5-way navigator
- Access extra features with menus
- Find and open applications quickly

In this chapter

Navigating around the screen	29
Using the keyboard	35
Opening and closing applications.	39
Using your Today screen	42

Navigating around the screen

To navigate around the smartphone screen, you can use the 5-way navigator or you can tap items on the screen with the stylus. As you become familiar with your smartphone, you'll find your own favorite way to scroll, highlight, and select items.

Using the 5-way, press **Right** ▶, **Left** ◀, **Up** ▲, or **Down** ▼ to move around the screen. Press **Center** ○ to highlight and select items.

TIP Some third-party applications may not work with the 5-way navigator, and you must use the stylus instead.

DID YOU KNOW? Custom navigation features are available when you browse the web using Internet Explorer Mobile (see [Viewing a web page](#)).

TIP The arrow icons used in this guide to indicate directions on the 5-way are different from the onscreen scroll arrows and the arrows that indicate that a list is available (see [Selecting options in a list](#)).

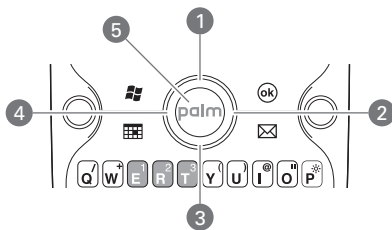

- 1 Up ▲
- 2 Right ▶
- 3 Down ▼
- 4 Left ◀
- 5 Center ○ (flashes when you have voicemail)



Scrolling through screens

As on a computer, on your smartphone you scroll to move from field to field or page to page, or in some cases to highlight an item or option in a list. There are several methods of scrolling:







- Press the 5-way on the front of your smartphone. Press **Right** ▶, **Left** ◀, **Up** ▲, or **Down** ▼ to move to the next field, button, or action in that direction.
- Press and hold **Option** ⏏ while pressing **Up** ▲ or **Down** ▼ to scroll one screen at a time. These keys work



just like the Page Up and Page Down keys on your computer keyboard.

TIP Can't find the Option key? See [Using the keyboard](#).

- Press and hold **Option**  while pressing **Left**  or **Right**  to jump to the top or bottom of the current document or entry.

TIP When you are using applications such as Messaging, Internet Explorer Mobile, and Word Mobile, press and hold **Option** while pressing **Left** or **Right** on the 5-way to automatically go to the top and bottom of a screen.

- When viewing a screen with tabs, such as when adding a contact, press **Down**  to scroll to the tabs, and then press **Left**  or **Right**  to move between tabs.
- When inside a text field, press **Right**  or **Left**  to move to the next character, and press **Up**  or **Down**  to move between lines.

- When inside a list, press and hold **Up**  or **Down**  to rapidly scroll through the list.
- Tap an onscreen scroll arrow.

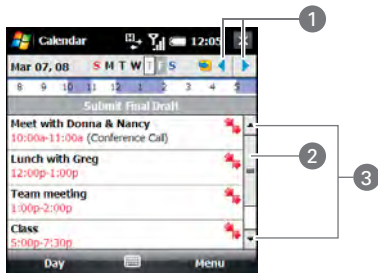



- 1 Scroll arrows
- 2 Scroll bar with slider
- 3 Scroll arrows

- Tap and drag the slider of an onscreen scroll bar.

Closing screens

To accept the information you entered on a screen and to return to the previous screen—or to return to the previous screen

without making any changes—do one of the following:

- Press **OK** .
- Use the stylus to tap  or  in the upper-right corner of the screen. These buttons are not accessible using the 5-way.

When you close a screen, the application continues running in the background.

TIP To close an app—as opposed to just a screen—press and hold OK or tap and hold OK on the screen (see [Opening and closing applications](#)).

TIP Can't find the stylus? It slides out from the lower-left corner on the back of your smartphone.

Highlighting and selecting items

On most screens, one item—a button, a list entry, or a check box—is highlighted by default. The highlight identifies which item is affected by your next action. Use the 5-way to move the highlight from one item to another before opening or selecting it.

TIP The best way to learn to use the 5-way is to experiment. Press the 5-way buttons, and as you do, follow the movement of the highlight around the screen. The behavior of the 5-way varies slightly in each application.

The highlight can take one of two forms, depending on what is highlighted:

Border: This rectangular border highlights items such as an onscreen button (such as OK, Dismiss, or Hide), a check box, an option, or a web link.

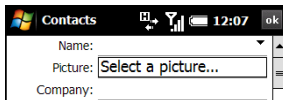

Light text on a dark background: This highlights items such as a phone number, an email address, text, or an item in a list.

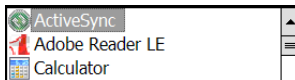

After highlighting an item with the 5-way, you can select or activate it by pressing **Center**  or by tapping the item with the stylus.

Highlighting text

You can use the stylus to highlight text on the screen. Tap and drag the stylus across the text you want to highlight. To highlight a word, double-tap it. To highlight a paragraph, triple-tap it.

TIP When text is highlighted, you can press **Backspace** to delete the highlighted text.

Using the softkeys

The left and right softkeys give you quick access to tasks that you can do on the current screen. The task a softkey does varies from application to application and from screen to screen. You activate the task by tapping the softkey with the stylus or pressing it with your finger.

The softkey is simply the name of the task on the screen. Softkeys appear in the lower-left and lower-right corners of the screen. In most cases the right softkey opens a menu, and the left softkey

performs a specific action, such as New or Edit. In some contexts, these keys may do nothing at all.



- 1 Left softkey: Press anywhere in this area to perform the task shown.
- 2 Right softkey: Works the same way.

Selecting menu items

In many applications, a menu provides access to additional features. The menu is hidden until you press Menu (right softkey). To get the most out of your smartphone, it's a good idea to familiarize yourself with the additional features available through the menus in various applications.

- 1 Press **Menu** (right softkey) to display an application's menu.

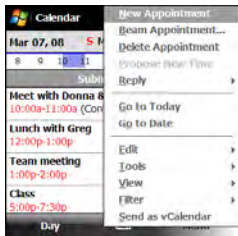

DID YOU KNOW? You can select most menu items by pressing a key on the keyboard. To quickly access a menu item, press **Menu** (right softkey) followed by the underlined letter in the menu item's name.

Selecting options in a shortcut menu

Most applications also provide access to context-sensitive shortcut menus—similar to the right-click menus on a Windows computer. The shortcut menu options vary based on the highlighted selection.

- 2 Press **Up** ▲ or **Down** ▼ to highlight a menu item.
- 3 If an arrow appears to the right of a menu item, press **Center** ○ or **Right** ► to display a submenu of additional options for that item, and then press **Up** ▲ or **Down** ▼ to highlight a submenu item. To return to the main menu without making a selection, press **Left** ◀.
- 4 Press **Center** ○ to select the menu item, or press **Left** ◀ or **Menu** (right softkey) to close the menu and cancel your selection.

- 1 Highlight the item whose shortcut menu you want to see.
- 2 Press and hold **Center** ○ to open the shortcut menu.

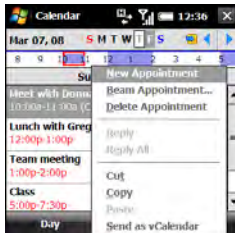

TIP You can also tap and hold the stylus on an item to open the shortcut menu.

- 3 Press **Up** ▲ or **Down** ▼ to highlight a menu item.
- 4 Press **Center** ○ to select the menu item, or press **Left** ◀ to cancel your selection.

Selecting options in a list

Lists enable you to select from a range of options. You can identify whether a list is available when you select a field. If a rectangle appears around the field along with a downward-pointing arrow, a list is available. Lists are different from the menus described earlier in this section.

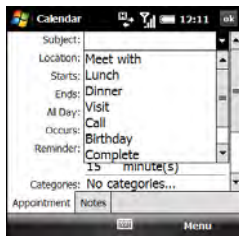
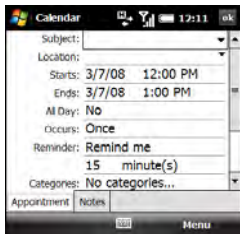

To select from a list, do any of the following:

- Use the 5-way to highlight the field, and then press **Center** ○ to display the items in the list. Press **Up** ▲ or **Down** ▼ to highlight the item you want, and then press **Center** ○ to make your selection.
- Use your stylus to tap the arrow, and then tap the item in the list.

DID YOU KNOW? If you highlight a field and don't see the downward-pointing arrow, press **Center** on the 5-way. If you see a field with a downward-pointing arrow but no rectangle, tap the arrow with the stylus to display the list.

Press **Left** ◀ to exit the list and cancel your selection.

Using the keyboard

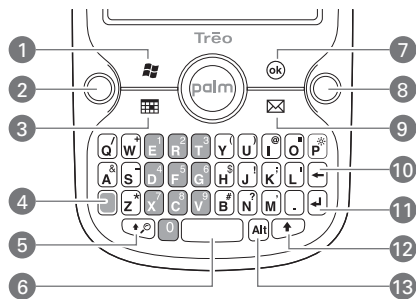

- 1 Start
- 2 Phone/Send
- 3 Calendar
- 4 Option
- 5 Shift/Search
- 6 Space
- 7 OK
- 8 End
- 9 Messaging

- 10 Backspace
- 11 Return
- 12 Shift
- 13 Alt

Understanding the keyboard backlight

Your smartphone includes a keyboard backlight for low light conditions. The keyboard backlight activates automatically when the screen turns on. The backlight dims when the screen dims, and it turns off automatically when the screen turns off or when you are on a call or playing music in the background for longer than the time specified in Backlight Settings. You can set different time intervals depending on whether the smartphone is operating on battery power or is connected to an external power source. The backlight also turns off when an application's power-saving features turn it off.

TIP You can change the backlight shut-off interval. Press **Start** and select **Settings**. Select the **System** tab, and then select **Backlight**. Set the time interval on the Battery power tab and on the External power tab.

Entering lowercase and uppercase letters

By default, the first letter of each sentence or field is capitalized and the remaining text you enter is lowercase. To enter other uppercase letters, do one of the following:

- Press **Shift** (↵) or (⇧) and then enter a letter. You don't need to press and hold Shift while entering a letter.
- Press **Shift** (↵) or (⇧) twice to turn on **Caps Lock** and then enter a series of letters. When Caps Lock is on, this symbol appears at the bottom of the screen: 🔦. To turn off Caps Lock, press **Shift** (↵) or (⇧) again.

TIP You can turn off the first-letter capitalization setting (see [Setting input options](#)).

DID YOU KNOW? You can also use the onscreen keyboard to enter letters, numbers, and other characters in applications that support this feature. Tap the keyboard icon in the center at the bottom of any screen where it appears. After opening the keyboard, you can set various input options by tapping the arrow to the right of the keyboard icon.

Entering numbers, punctuation, and symbols

Numbers, punctuation, and symbols appear above the letters on the keys. To enter these characters, do one of the following:

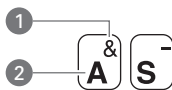

- 1 Symbol
- 2 Letter

- Press **Option** (⌘) and then press the key of the desired character. You don't need to hold Option while pressing the key.
- Press **Option** (⌘) twice to turn on **Option Lock** and then press the desired keys to enter a series of characters. When Option Lock is on, this symbol appears at the bottom of the screen: 🔦. To turn off Option Lock, press **Option** (⌘) again.

Entering passwords

You can't see your password as you enter it, so be careful. Be sure Caps Lock and Option Lock are not on unless you need them. For information on how to enter characters, see [Entering lowercase and uppercase letters](#) and [Entering numbers, punctuation, and symbols](#).

Entering other symbols and accented characters

You can enter symbols and accented characters that don't appear on the keys by using the alternate characters list.

TIP The alternate characters are grouped according to their similarity to the corresponding key. For example, the alternate character available for the R key is ®, and for the T key is ™. If you press the wrong key, press **Backspace** to return to the full list of alternate characters. You can then press another key.









- 1 Press **Alt**  to display the alternate character list.
- 2 Narrow the list by pressing the key that corresponds to the character you want. For example, to enter an é, press **e**. See the table below for a list of corresponding characters.
- 3 Press **Up** ▲ or **Down** ▼ to highlight the desired character.
- 4 Press **Center** ○ to insert the character.

TIP Some symbols, such as an underscore (_), do not correspond to a letter key. To enter these symbols, press **Alt** by itself and then select the symbol from the list.

Symbols and accented characters

Press Alt  and press...	to select...
a	á à â ã ä å æ
A	Á Â Ã Ä Å Æ
b or B	ß
c	ç ç ©
C	Ç ç ©
e	é è ê ë

Press Alt  and press...	to select...
E	É Ê Ë Ì
f or F	<i>f</i>
i	í î ï
l	ì ï
l or L	£
n	ñ
N	Ñ
o	ó ò ô õ ö ø ò
O	Ó Ô Õ Ö Ç È Ò
p or P	¶
r or R	®
s	ß š
S	ß Š
t or T	™
u	ú û ü û
U	Ú Û Ü Û
x or X	x □
y	ý ŷ
Y	Ý Ÿ

Press Alt  and press...	to select...
0	°
1 ( + E)	1 ¼ ½
2 ( + R)	2
3 ( + T)	3 ¾
! ( + J)	¡
\$ ( + H)	€ £ ¥ ¢
; ( + K)	: :-) :-(;-)
? ( + N)	¿

Press Alt  by itself to select these characters:

: _ • % = ÷ ^ \$ € £ ¥ ¢ \$ [] { } < > « » © ®
° ~ \ Ø μ |

Opening and closing applications

Opening applications on the Start menu

- 1 Press **Start**  to open the Start menu.
- 2 Use the 5-way navigator to highlight the application you want to use. To open a recently used application, highlight its icon at the top of the Start menu.

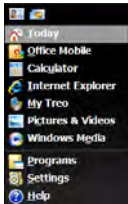

- 3 Press **Center**  to open the highlighted application.

TIP With the Start menu open, press the letter underlined in the application's name to open the app. For example, press **H** to open Help.

DID YOU KNOW? You can open apps by pressing and holding **Option** and then pressing **Phone/Send, Start, OK, Calendar,** or **Messaging**. You can change which app a button combination opens (see [Reassigning buttons](#)).

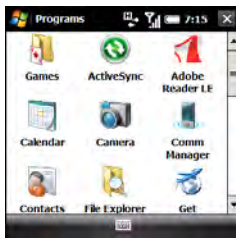

Opening applications in Programs

- 1 Press **Start**  and select **Programs**.



- 2 Use the 5-way navigator to highlight the application you want to use.

TIP In Programs, press a letter to jump to the first app that begins with that letter. For example, press **C** to jump to Calculator, press **C** again to jump to Camera, and so on.

- 3 Press **Center**  to open the highlighted application.
- 4 (Optional) Press **OK**  to return to Programs and open another application. The current application continues to run in the background.

Switching among open applications

- 1 Go to your Today screen.
- 2 Tap the **running programs**  icon in the upper-right corner to open the Quick Menu.
- 3 Select the program you want to use.

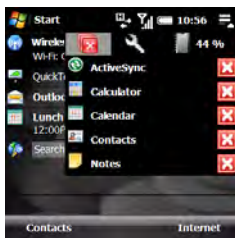

TIP You can also use the Quick Menu to close applications, open Task Manager, and check system memory.

Closing applications

Press **OK**  to remove the current application from the screen.

Applications that you open stay open in the background even after you press OK to remove them. If you want to stop them, you must do it manually. That's usually not necessary; but if you're concerned about power usage, stop some or all applications.

- 1 Press and hold **OK**  to open Task Manager.
- 2 Do one of the following:

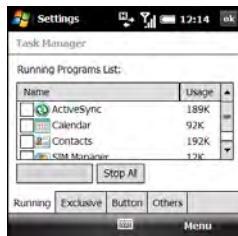

To close one or more individual applications: Check the boxes next to the applications and select **Stop Selected**.

To close all applications except the ones you specify: Check the boxes next to the applications you do not want to close, press **Menu** (right softkey), and select **Stop All but Selected**.

To close all open applications: Select **Stop All**.

TIP If an X appears in the upper-right corner of an application screen, you can tap and hold the **X** with the stylus to close the application. You can turn this feature on and off or change it so that simply tapping X closes an application. Press and hold **OK** to open Task Manager, select the **Button** tab and then select the option you want.

Defining exclusive programs

You can mark an application as exclusive. An exclusive application remains open even if you stop individual or all applications.

- 1 Press and hold **OK**  to open Task Manager.
- 2 On the Running tab, tap and hold the app name with the stylus.
- 3 Select **Add Exclusive**.

TIP To remove an application from the Exclusive Programs list, press and hold **OK** to open Task Manager. Select the **Exclusive** tab, check the box next to the application name, and select **Remove**.

Customizing the Quick Menu

- 1 Press and hold **OK**  to open Task Manager.
- 2 To remove the Quick Menu from your Today screen, select the **Button** tab and uncheck the **Enable Quick Menu on Today screen** **Today** screen box.

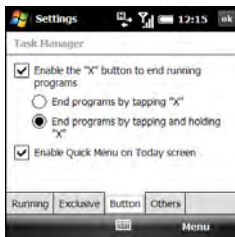

- 3 Select the **Others** tab and select the sort method for programs in the Quick Menu.

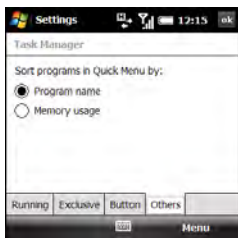

Using your Today screen

The Today screen lets you see your current appointments and messages at a glance. You can also make a call, search the web, and manage your smartphone from your Today screen.

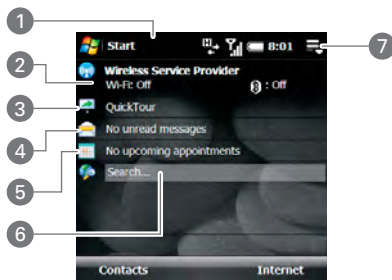

To access your Today screen, press **End** .

TIP Don't press End to access the Today screen if you're on a call, because that hangs up the call. Instead, press **Start** and select **Today**.



- 1 Title bar and status info:** See [What are all those icons?](#)
- 2 Wireless service indicator:** Shows whether the Bluetooth® technology and Wi-Fi features are on or off. Also displays your wireless service provider name if the phone is on.
- 3 Quick Tour:** Select to open the Quick Tour, which introduces you to many of your smartphone's features.

TIP You can remove the Quick Tour entry from your Today screen. Open the Quick Tour and select **Remove Quick Tour**.

- 4 Messaging status field:** Shows the number of unread email, text, and multimedia messages. Email messages are listed by email account. Select an account or select **SMSWMS** to open the corresponding Inbox.
- 5 Calendar status field:** Shows upcoming appointments. Select this field to open the Calendar application.
- 6 Web search field:** Enter the web address or keyword you want to find, and press **Center**  or **Return**  to view a list of search results (data services connection required).
- 7 Running programs icon:** Tap to open the Quick Menu, which shows all open applications so you can quickly switch between or close them.

TIP You can select a picture for your Today screen background and select which items appear in the Today screen. See [Today screen settings](#) for details.



Your phone

The Today screen and the Phone screen are the key locations for making and receiving calls.

You can creatively manage multiple calls. For example, you can swap between calls, send text messages to ignored calls, and create conference calls.

Benefits

- Stay in touch—you choose how
- Work in other applications when on an active call

In this chapter

Turning your smartphone on/off	47
Making calls	49
Receiving calls	53
Using voicemail	54
What can I do during a call?	55
Working with called numbers	61
Assigning a speed dial to a phone number	63
What are all those icons?	65
Using a phone headset	68
Customizing phone settings	72

Turning your smartphone on/off

The term smartphone refers to the device and its physical aspects. The term *phone* refers to the wireless feature of your Palm® Treo™ Pro smartphone that enables you to connect to your wireless service provider's network so that you can make and receive calls and send and receive data.

The phone and the screen of your smartphone can be turned off and on separately. This means you can wake up the screen to use just the organizer features of your device (Calendar, Contacts, Tasks, Notes, and so on) without turning on the phone. Also, when the screen is turned off, the phone can be on and ready for you to receive phone calls or messages.

Turning your phone on

When you turn on your phone, it connects to a mobile network so that you can make and receive phone calls and use other wireless services (if supported by the local network).

BEFORE YOU BEGIN To use the phone, you must have an active SIM card from your wireless service provider inserted into your smartphone (see [Inserting the SIM card and battery](#)).

To turn on your phone, press and hold **Power** .

When your smartphone locates a signal, your wireless service provider's name appears in the upper-left of the screen and the **signal-strength**  icon appears at the top of the screen.

When you are inside a coverage area, the **signal-strength**  icon has bars in it. If you're outside a coverage area, no bars appear in the signal-strength icon.

Turning your phone off



Press and hold **Power** .

When your phone is off, the **phone-off**  icon appears at the top of the screen and **Phone off** appears in the upper-left of the screen. Your phone is not connected to any mobile network. Although you can no longer use the phone, you can still use Microsoft Office Mobile® apps and all the organizer features of your smartphone.







TIP When you turn off your phone using the Power button, this turns off all radios on your smartphone, which include the phone, the Bluetooth® wireless technology feature, and the Wi-Fi feature. This is sometimes referred to as *airplane mode* or *flight mode*. To turn off the phone or other wireless radios individually, use Comm Manager. Select your wireless service provider name on your Today screen, or tap the signal-strength icon on any screen and select **Comm Manager**.

Waking up the screen and turning it off

Wake up the screen and leave the phone turned off when you want to use only the organizer features of your smartphone, for example, when you're on a plane and want to look at your calendar. You can also turn off the screen without turning off the wireless features on your smartphone.

The screen turns off automatically after a preset period of inactivity. You can turn your screen off manually by pressing and holding **End**  or by pressing **Power** . If the Today screen is displayed and you are not on a call, you also turn the screen off manually by pressing **End** .

DID YOU KNOW? You cannot turn the screen off if you are on a call.

To turn the screen back on, press **Power**  or any of the following buttons on the front of your smartphone: **Phone/Send** , **Start** , **Calendar** , **Messaging** , or **End** .

TIP The first time you take your smartphone out of the box, you need to remove the battery and reinsert it to wake up the screen (see [Inserting the SIM card and battery](#)).

When the screen is off but the phone is on, a screen saver appears showing the date and time as well as the following indicators:

NOTE Not all wireless service providers support the screen saver feature.



One or more missed calls



One or more unread text or multimedia messages

TIP You can set how long the screen stays on during a period of inactivity. You can also turn off the screen saver feature (see [Optimizing power settings](#)).

Making calls

Dialing from the Today screen

- 1 Press **End**  to open your Today screen.
- 2 Using the keyboard, enter a phone number.



- 3 Press **Phone/Send**  to dial.

NOTE You do not need to press Option  to enter numbers, *, or #. This makes it easy to respond to further dialing instructions. When dialing short numbers, however, the numbers may match the letters of a contact name. If this occurs,

press **Option**  to avoid starting a contact lookup.

TIP If the numbers you are entering match a phone number you have for a contact, the contact name is displayed. Select the name to dial the associated number (see [Dialing by contact name](#) for more information).

Dialing with a speed dial

BEFORE YOU BEGIN Create some speed dials (see [Assigning a speed dial to a phone number](#)).

- 1 Press **End**  to open your Today screen.
- 2 Press and hold the key or keys that you assigned as a speed dial to the contact number you want to call. If you have assigned a two-digit speed dial to this number, press the first key and then press and hold the second key.

Dialing by contact name

You can look up contacts quickly by entering just a few letters of a contact's name directly from your Today screen.



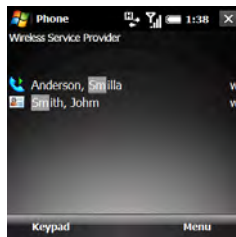

BEFORE YOU BEGIN Create some contacts (see [Adding a contact](#)) or import them by synchronizing (see [Synchronizing information](#)).

- 1 Press **End**  to open your Today screen.
- 2 Using the keyboard, begin entering any combination of letters from the contact's first and/or last name. If you use both first- and last-name letters, separate them by a space. You can type letters from the last name first.



To delete letters when correcting a misspelled name, press **Backspace** .

TIP If you press E, R, or any other key that displays both a letter and a number, you see onscreen not only matching names but the number as well. The numbers do not affect the process for dialing by contact name.

- 3 Matching contacts are displayed with a code for the type of number you last entered for that contact: “w” for work, “m” for mobile, and so on.
 - If the contact name appears with the code for the number you want to dial, highlight the name and press **Phone/Send**  to dial the number.
 - If you want to dial a different number for a displayed contact, highlight the contact name and press **Left**  or **Right**  until the code you want appears. Press **Phone/Send**  to dial the number associated with the code.

Dialing using the onscreen keypad

The onscreen keypad is useful when you need to dial numbers that are expressed as letters and when you need large numbers that you can tap with your finger or the stylus.

DID YOU KNOW? You can paste numbers directly into the keypad. Copy a number from another application, switch to keypad, press **Menu** (right softkey), and then select **Paste** to paste the number.



- 1 Press **Phone/Send**  and then press **Keypad** (left softkey).
- 2 Tap the onscreen keypad to enter the number.



- 3 Press **Phone/Send**  to dial.

Redialing a recently called number

To dial the last number you called: Press **Phone/Send**  twice.

To select from your most recently dialed numbers: Press **Phone/Send** , highlight the number or contact name you want to call, and then press **Phone/Send**  to dial.

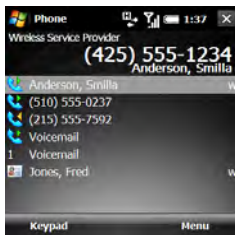



TIP You can manage information about a recently called number in several ways (see [Working with called numbers](#)).

Dialing your national emergency number

You can dial your national emergency number (such as 911, 112, or 999) anytime. Just wake up the screen and enter the emergency number. If the phone is turned

off, you don't have to turn it on. You don't have to press **Option** .

If you lock your smartphone and select Simple PIN as the password type, dial the emergency number by entering the number in the password field and pressing **Phone/Send** .

If you select Strong alphanumeric as the password type, however, you must press **Option**  twice before entering the number in the password field. See [Locking your smartphone](#).

Dialing from a web page or message

Your smartphone recognizes most phone numbers that appear in web pages or in messages (text, email, or multimedia).

- 1 Use the 5-way to highlight the phone number you want to dial in the web page or message.
- 2 Verify or edit the number.
- 3 Press **Phone/Send**  to dial.

TIP If you can't dial a phone number directly from a web page or a message, highlight the number, select **Edit** (right softkey), and then select **Copy**. Open the Keypad, press **Menu** (right softkey), and select **Paste**. Press **Phone/Send** to dial.

TIP Select a phone number in a message, press **Menu** (right softkey), and then press **Save to Contacts** to create a new contact containing the highlighted information or edit an existing contact to include the highlighted information.

Receiving calls

If you want to answer calls, your phone must be on. This is different from having only the screen turned on (see [Turning your phone on](#)). When your phone is off, your calls go to voicemail.

TIP See a picture of the person calling you! Learn how to assign a caller ID picture in [Adding a contact](#).

If music is playing when a call arrives, the smartphone rings softly. You can answer the phone as you normally would. The audio pauses during your call.

To answer a call, do one of the following

- Press **Accept** (left softkey).
- Press **Phone/Send** .
- If the headset is attached, press the headset button.

To ignore a call and send it to voicemail, do one of the following:





- Press **Ignore** (right softkey).
- Press **End** .

DID YOU KNOW? You can set your phone to automatically answer calls (see [Setting your phone to automatically answer calls](#)).

To silence the ringer while your smartphone is ringing, do one of the following:

- To immediately silence all system sounds including the ringer, slide the **Ringer** switch to **Sound Off** . All



sounds remain off until you slide the Ringer switch back to Sound On .

- Press the **Volume** button.
- Press any letter key. (Don't press Phone/Send , End , Alt , Start , OK , or the 5-way.)

When you silence the ringer, you can either answer the call or let it ring through to voicemail.



Using voicemail

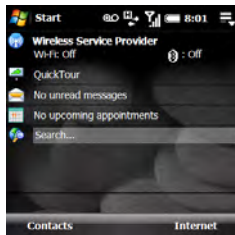

Setting up voicemail

- 1 Press **End** .
- 2 Press and hold **1**  on the keyboard to dial your wireless service provider's voicemail system.
- 3 Follow the voice prompts to set up your voicemail.

Listening to voicemail from the Today screen



When you have unretrieved voicemail messages, a **voicemail**  icon appears at the top of your screen and **Center**  on the 5-way flashes.

- 1 Press **End** .
- 2 Press and hold **1** .
- 3 Enter your voicemail password.
- 4 Follow the voice prompts to listen to your messages.

DID YOU KNOW? When the **voicemail** icon appears at the top of the screen, you can tap this icon to retrieve your voicemail.

TIP You can turn off the Center button voicemail notification. Press **Start** and select **Settings**. On the Personal tab, select **Phone**. Select the **Beacon** tab and uncheck the option to illuminate Center when voicemail arrives.

Retrieving messages from a voicemail notification

NOTE Not all service plans support voicemail notification. Check with your wireless service provider for more information.

When you have a new voicemail message, a notification screen appears.

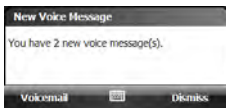

- To hear your message now, press **Voicemail** (left softkey).
- To retrieve your message later, press **Dismiss** (right softkey).

What can I do during a call?

Your smartphone offers many advanced telephone features, including call waiting, six-way conferencing, and call forwarding. These features depend on your service plan. Contact your wireless service provider for more information.

When you make or receive a call, info about the call appears on your Phone screen. If you move away from the Phone screen, press **OK** [Ⓜ] until you return there.

TIP From the Today screen, you can also return to the Phone screen by pressing **Call Status** (left softkey).

You can do any of the following on the Phone screen:

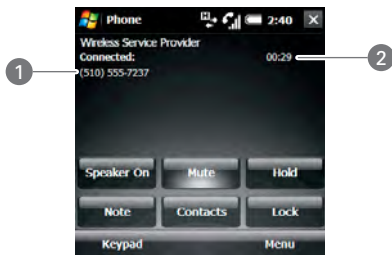

- 1 Caller's name and/or number
- 2 Current duration of call

Use the speakerphone: Select **Speaker On**. To turn off the speakerphone, select **Speaker Off**.

Mute the microphone so you can't be heard: Select **Mute**. To unmute the microphone, select **Unmute**.

Put the call on hold: Select **Hold**. To take the call off hold, select **Unhold**.

Jot down a note about your call: Select **Note**. To return to the Phone screen after you have finished writing the note, press **OK** [OK].

To lock the screen during a call so you don't accidentally activate any onscreen buttons or other items: Select **Lock**. To unlock the screen select **Unlock**.

DID YOU KNOW? You can set the screen to be locked by default when you are on a call (see [Locking your screen](#)).

TIP When a call lasts longer than one minute, the screen dims. After two minutes, it dims more. Press any key except End to light up the screen.

DID YOU KNOW? You can send and receive text messages during a call. This is a great way to stay connected with colleagues during a long call.

Ending a call



Do one of the following:

- Press **End** [End].
- Press the headset button (if the headset is attached and has a button on it). Some headsets do not have a button.

Switching applications during a call

Press **Start** [Start] and select the application. This is easiest when using the speakerphone or a headset.

You can open the Contacts application directly from the Phone screen by selecting **Contacts**.

From any application, press **Phone/Send**  to return to your Phone screen. To go to your Today screen, press **Start**  and select **Today**.

You can use many other applications on your smartphone, including the organizer and text message features, while holding a phone conversation. You cannot, however, make some data connections during an active call while connected to a GPRS network. If you're connected to a GPRS network, you cannot browse the web or send and receive email or MMS messages while on a voice call. If you're connected to a UMTS (3G or HSDPA) network, you can perform simultaneous voice and data functions. How can you tell which kind of network you're connected to? See [What are all those icons?](#)

NOTE Some wireless service providers do not support simultaneous voice and data functions over an HSDPA network. Check with your wireless service provider for information.

Saving phone numbers

After you hang up a call, you can add the number of the person you were talking with to Contacts if it's not already in your list. If an incoming call uses caller ID blocking, you cannot save the number.

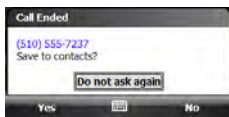

- 1 On the prompt that appears after you hang up the call, press **Yes** (left softkey).
- 2 Do one of the following:

Create a new contact: Select **<New Contact>**.

Add this number to an existing contact: Select the contact name.

Decline adding the number: Press **Cancel** (right softkey).

TIP You can turn off the Save to Contacts prompt. When the prompt appears, select **Do not ask again**.

If you don't add a number right away, follow these steps to add it later:

- 1 Press **Phone/Send** .
- 2 Highlight the number you want to save.
- 3 Press **Menu** (right softkey) and select **Save to Contacts**.
- 4 Do one of the following:

Create a new contact: Select **<New Contact>**.

Add this number to an existing contact: Select the contact name.

Decline adding the number: Press **Cancel** (right softkey).

Making a second call

You can make a second call while your first call is still active:

- 1 Place your first call on hold by selecting **Hold**.
- 2 Press **Smartdial** (left softkey).
- 3 Dial the second number you want to call. Or, if the number appears on the recent calls list, highlight the number.
- 4 Press **Phone/Send** .

Answering a second call (call waiting)

When you're on a call and you receive a second call, the call waiting notification appears if you have chosen to be notified (see [Setting call waiting notification](#)). You can do either of the following:

Send the new call to voicemail: Press **Ignore** (right softkey).

Place the current call on hold and answer the new call: Press **Accept** (left softkey) or press **Phone/Send** .

Working with two active calls

When two calls are active, your Phone screen includes two call status sections, each representing one of the calls. You can do either of the following:

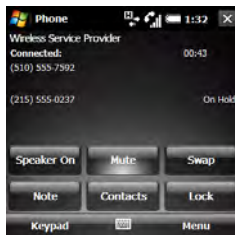

- Select **Swap** to move between callers by placing the current active call on hold and talking on the other line.
- Make the calls a conference call. See [Making a conference call](#).

Making a conference call

IMPORTANT You can join up to 5 calls into a 6-way conference call. The number of calls you can join in conference depends on your service plan. Additional charges may apply, and minutes in your mobile account may be deducted for each call. Please contact your wireless service provider for more information.



- 1 Answer a second call (see [Answering a second call \(call waiting\)](#)), or put the first call on hold and make a second call (see [Making a second call](#)).
- 2 Press **Menu** (right softkey) and select **Conference**. This joins the two calls with you in a conference.

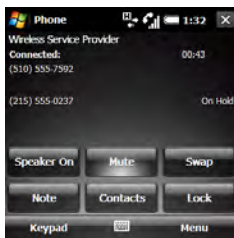

Make more calls and add them to the conference call. The number of calls you can add to the conference depends on your service plan.

- 3 (Optional) Extract a caller from the conference call to talk with them privately by pressing **Menu** (right softkey), selecting **Private**, and then selecting the phone number. The extracted call becomes the active call. Swap between the conference call and the private call by selecting **Swap**. To return the private call to the conference, press **Menu** (right softkey) and select **Conference**.



- 4 When you're done, do one of the following:
 - If you have not extracted a call, press **End**  once to hang up all calls.
 - If you have extracted a call, press **End**  twice to hang up all calls or press **End**  once to hang up the active call.

Forwarding calls

You can forward calls to another phone number. Please check with your wireless service provider about availability and pricing of forwarded calls; additional charges may apply.

When all calls are forwarded, the call forwarding  icon appears in the upper-right corner of the Phone screen.

- 1 Press **Start**  and select **Settings**.
- 2 On the Personal tab, select **Phone**.
- 3 On the Services tab, highlight **Call Forwarding**.
- 4 Select **Get Settings**.
- 5 Specify your call forwarding settings. Some of the settings may already be set by your wireless service provider to send your calls to voicemail.

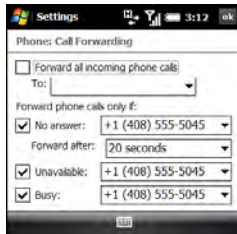

- 6 Press **OK** .

Working with called numbers

You can redial a number you've recently called (see [Redialing a recently called number](#)). You can also view call details, send a text message to a number, save a number to your contact list, and more.

Working with recently called numbers

1 Press **Phone/Send** .

TIP On the recent calls list, outgoing calls are designated by a right-pointing green arrow, and incoming calls are designated by a left-pointing yellow arrow. Missed calls are designated by a red exclamation point.

TIP To filter the displayed information, press **Menu** (right softkey), select **View**, and then select whether you want to view all calls and contacts, all calls only, or speed dials only.

2 Highlight the number you want and do one or more of the following:

Save the phone number to a contact: See [Saving phone numbers](#).

Send a text message to the number:

Press **Menu** (right softkey) and select **Send Text Message**. Enter the message text and press **Send** (left softkey).

Create a note containing the phone number:

Press **Menu** (right softkey) and select **Save to Notes**.

View more details about the number:

Select the number to open the call. The first entry shows the length of your last call with this number. Use the other entries to call the number or send a text message.

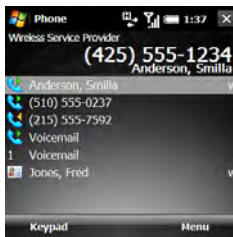

- 3 With the call open, do either of the following:

View all calls with this number, including their duration: Press **Menu** (right softkey) and select **View All Calls**. If you select this option, you can delete all calls from this number by pressing **Menu** (right softkey) and selecting **Delete All Calls**.

Delete the call from the recent calls list: Press **Menu** (right softkey) and select **Delete Call**. Select **Yes** to confirm the deletion.

Viewing all of your calls

Your Call History list contains the number for all incoming and outgoing calls.

- 1 Press **Phone/Send** .
- 2 Press **Menu** (right softkey) and select **Call History**.

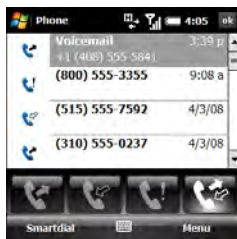

TIP You can also open the Call History list when you are on a call or when the Keypad is displayed.

- 3 To filter the Call History list, select one of the following buttons:



Display outgoing calls.



Display incoming calls.



Display missed calls.



Display all calls.

- 4 Highlight the number you want and do one or more of the following:

Save the phone number to a contact: See [Saving phone numbers](#).

View a note associated with the phone number: Press **Menu** (right softkey) and select **View Note**.

Delete the call from the list: Press **Menu** (right softkey) and select **Delete**. Select **Yes** to confirm the deletion.

Send a text message to the number: Press **Menu** (right softkey) and select **Send Text Message**. Enter the message text and press **Send** (left softkey).

Delete the entire Call History List: Press **Menu** (right softkey) and select **Delete All Calls**. Select **Yes** to confirm the deletion.

View timers for your most recent calls and for all calls: Press **Menu** (right softkey) and select **Call Timers**.

TIP To reset all call timers to zero, select **Reset**.

Assigning a speed dial to a phone number

You can assign a speed dial to any contact phone number. You can assign up to 99 speed dials.

BEFORE YOU BEGIN Before you can assign a speed dial to a contact phone number, you must create some contacts (see [Adding a contact](#)) or import them by synchronizing (see [Synchronizing information](#)).

- 1 From your Today screen, press **Contacts** (left softkey).
- 2 Select the contact to whom you want to assign a speed dial.
- 3 Highlight the phone number to which you want to assign a speed dial.
- 4 Press **Menu** (right softkey) and select **Add to Speed Dial**.

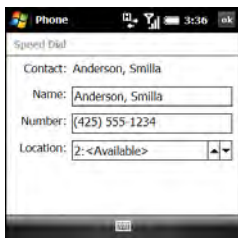

- 5 If you want to change the name for this speed dial, select the **Name** list and enter a new name.
- 6 Select the **Location** list, and then select the speed dial you want to assign to this phone number. Press **Up** ▲ or **Down** ▼ to scroll the list of available speed dials.

DID YOU KNOW? You cannot assign 0 (zero) or 1 as a speed dial. The number 0 is reserved for entering the + symbol in a phone number, and the number 1 is reserved for dialing your voicemail system.

TIP You can also assign a speed dial to a contact from the recent calls list. Press **Phone/Send** to open the list, press **Menu** (right softkey), and select **Speed Dial**. Press **Menu** (right softkey), select **New**, and then select the contact to whom you want to assign a speed dial.

To view a list of all your speed dials, press **Phone/Send** ○, press **Menu** (right softkey), and select **Speed Dial**.

What are all those icons?

You can monitor the status of several items using icons at the top of your Today screen or your Phone screen:



You missed an incoming call.



You have a voicemail message.



A new multimedia message is being downloaded to your smartphone.



A multimedia message could not be downloaded.



You have a new multimedia message.



You have a new text message.

NOTE You can turn on a setting to have a notification icon  appear when you have a new email message (see [Selecting Sounds & Notifications](#)).



No SIM card is inserted or software is unable to recognize the SIM.



You have more than one of the conditions listed above. Tap the icon to view the notifications.



Your phone is on. The bars display the signal strength. The stronger the signal, the more bars that appear. If you are outside a coverage area, no bars appear.



Your phone is off.



The SIM card is locked. You need to enter a PIN or a PUK to unlock the SIM card (see [Locking the SIM card](#)).



A voice call is in progress.



The speakerphone is on.



A call is on hold.



The microphone is muted.



The screen is locked.



All calls are being forwarded.



You are in a roaming coverage area. Additional fees may apply for calls or data transmission.



Your smartphone's Wi-Fi feature is turned on, but you are not connected to a Wi-Fi network.



Your smartphone is connected to a Wi-Fi network, but you are not actively transmitting data.



Your smartphone is connected to a Wi-Fi network and you are actively transmitting data.



ActiveSync synchronization is in progress.



Your smartphone is connected to a computer or network, or Windows Mobile Device Center synchronization is in progress.



A data connection is not available or your phone is off.



Your smartphone's battery is low.



Your smartphone's battery is being charged.



Your smartphone is connected to a power outlet and the battery is fully charged.

Wireless service provider name



Your phone is on. When you turn off your phone, **Phone Off** appears instead.



A call is in progress and your smartphone is connected to a Bluetooth headset or car kit.

You have a reminder. If the reminder is not displayed on your Today screen, tap the icon to open the reminder.



You have an alert from Microsoft. If the alert is not displayed on your Today screen, tap the icon to open the alert.



Your GPS satellite data has expired (see [Determining your GPS location](#)).



Your phone is connected to a 3G UMTS network, but you are not actively transmitting data. You can still make or receive calls.



Your phone is on and a 3G UMTS data connection is active. You can make and receive calls and transmit data simultaneously.



Your phone is connected to a HSDPA UMTS network, but you are not actively transmitting data. You can still make or receive calls.

NOTE In most cases, when your phone is connected to a UMTS network (either 3G or HSDPA) but you are not actively transmitting data, the 3G icon appears. The H icon may appear when your phone is connected to a HSDPA UMTS network, but you are not actively transmitting data.



Your phone is on and an HSDPA UMTS data connection is active. You can make and receive calls and transmit data simultaneously.



Your phone is connected to an EDGE network, but you are not actively transmitting data. You can still make or receive calls.



Your phone is on and an EDGE data connection is active. You can still make or receive calls, but the data transmission is automatically interrupted.



Your phone is connected to a GPRS network, but you are not actively transmitting data. You can still make or receive calls.



Your phone is on and a GPRS data connection is active. You can still make or receive calls, but the data transmission is automatically interrupted.

Using a phone headset

You can connect a phone headset for hands-free operation. You can use either the headset that came with your smartphone or a compatible third-party headset.

IMPORTANT If driving while using a smartphone is permitted in your area, we recommend using a headset or hands-free car kit (both sold separately). However, be aware that use of a headset that covers both ears impairs your ability to hear other sounds. Use of such a headset while operating a motor vehicle or riding a bicycle may create a serious hazard to you and/or others, and may be illegal. If you must use a stereo headset while driving, place a speaker in only one ear. Leave the other ear free to hear outside noises, and do so only if it is legal and you can do so safely.

Using a wired headset

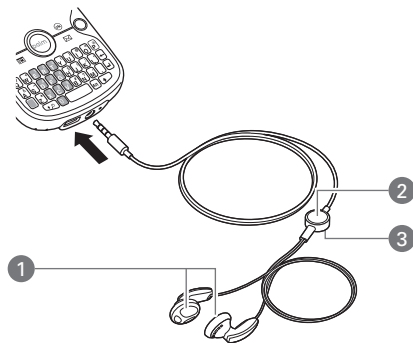

- 1 Speakers
- 2 Microphone
- 3 Headset button

The headset button performs different actions depending on what's happening on the phone. Press the headset button once to perform any of the following tasks:

- Answer an incoming call
- Respond to call waiting

- Hang up a single active call or all calls on a conference call if there is no extracted call
- Swap between calls if there is one active call and one call on hold

NOTE Your smartphone works with headsets that have a 3.5mm connector (look for three colored bands on the plug). When in doubt, ask the third-party headset manufacturer if the product is compatible with your smartphone. If you hear a headset buzz or poor microphone performance, your headset may be incompatible with your smartphone.



Connecting to a Bluetooth® hands-free device

Your smartphone is also compatible with many headsets and car kits (sold separately) enabled with Bluetooth® wireless technology version 2.0 and earlier versions.

For a list of compatible hands-free devices with Bluetooth wireless technology, go to palm.com/treoproumts-support.

After you set up a connection with a Bluetooth headset or hands-free car kit, you can communicate with that device whenever it is within range and the Bluetooth feature on your smartphone is turned on. The range varies greatly, depending on environmental factors. The maximum is about 10 meters (30 feet).

DID YOU KNOW? If you have both a compatible Bluetooth headset and a car kit, the one you connected to your smartphone last becomes the active device.

- 1 If necessary, prepare the device with which you want to connect to accept a new connection. Check the device's documentation for details. Be sure to find out if the device has a predefined passkey that you need to enter on your smartphone in step 8.
- 2 On your smartphone, press **Start**  and select **Settings**.
- 3 Select the **Connections** tab, and then select **Bluetooth** .

- 4 Select the **Mode** tab and check the **Turn on Bluetooth** box.
- 6 Wait for your smartphone to search for devices and to display the device list.



- 5 Select the **Devices** tab, and then select **Add new device**.
- 7 Highlight the device with which you want to connect and press **Next** (right softkey). If the device you want does not appear, select **Refresh**.



- 8 If prompted, enter a passkey between 1 and 16 digits long and press **Next** (right softkey). For some headsets, the passkey is entered automatically. If you are not prompted for a passkey, skip to step 10.

IMPORTANT Some hands-free devices have a predefined passkey. If your hands-free device has a predefined passkey, you can find it in the documentation for that device. Other devices provide a screen where you enter

a passkey that you make up. In either case, you must use the same passkey on both your smartphone and your hands-free device. We recommend that you use a passkey of 16 digits, where possible, to improve the security of your smartphone. The longer the passkey, the more difficult it is for the passkey to be deciphered.

- 9 If the passkey is not predefined, enter the same passkey on the other Bluetooth device and press **Finish** (right softkey).
- 10 (Optional) Press **Advanced** (right softkey) and make sure that the **Hands Free** box is checked. Press **Save** (right softkey).
- 11 Press **Done** (left softkey).
- 12 Press **OK** .

You can now communicate with this device whenever it is within range and the Bluetooth feature on your smartphone is turned on. The range varies greatly, depending on environmental factors. The maximum is about 10 meters (30 feet).

Using a Bluetooth hands-free device

To learn how to set up and connect to Bluetooth devices, see [Connecting to a Bluetooth® hands-free device](#).

Here are tips for working with a Bluetooth hands-free device:



- To transfer a call from the handset to a Bluetooth hands-free device during a call, on the Phone screen, press **Menu** (right softkey) and select **Turn Hands-free On**. To transfer the call to the handset, press **Menu** (right softkey) and select **Turn Hands-free Off**.
- DID YOU KNOW?** If you're using a Bluetooth hands-free device and it is within range, your smartphone automatically routes all calls to the hands-free device instead of to the earpiece on your smartphone.
- To transfer a call from a wired headset to a Bluetooth headset or car kit that is within range and with which you've previously set up a partnership (Bluetooth headset or car kit required, sold separately), unplug the wired headset and press the button on the Bluetooth headset or car kit.

- To find out how to transfer your contacts from your smartphone to your car kit, go to palm.com/treoproumts-support.

Customizing phone settings

Selecting ringtones and display notices

You can set different tones for different types of incoming phone calls and notifications. You can download MP3, MIDI, AMR, WAV, and WMA ringtones directly to your smartphone (see [Downloading files and images from a web page](#)). You can also download ringtones to your computer and then email them to your phone.

- Press **Start**  and select **Settings**.
- On the Personal tab, select **Sounds & Notifications** .
- Select the **Notifications** tab.

- Select the **Event** list, and then select the type of call for which you want to set the ringtone:

Phone: Known Caller: An incoming call from someone in your Contacts list or Speed Dial list.



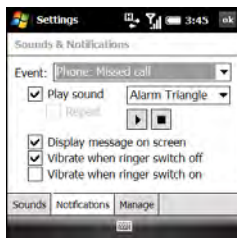

Phone: Missed call: A call you did not answer.



Phone: Roaming: A call that comes in when you're outside your home mobile network.

Phone: Unknown Caller: An incoming call from someone identified by caller ID who is not in your Contacts list or Speed Dial list.

Phone: Voice mail: A new voicemail.

- 5 If you selected Known Caller, Roaming, or Unknown Caller, select the ring type and the ringtone. Select the **Play**  icon to preview the ringtone sound.
- 6 If you selected Missed call or Voice mail, set the following options:
 - Check the **Play Sound** box if you want to have a sound played when the event occurs.
 - If you checked the **Play Sound** box, then select the sound for the selected type of call. You can also check the **Repeat** box to have the sound repeat.
 - (Optional) Select the **Play**  icon to preview the sound.
 - Check the **Display message on screen** box to have a message displayed when the event occurs.

- 7 Check the **Vibrate when...** boxes to turn the vibrate feature on/off based on the **Ringer** switch setting.
- 8 Repeat steps 4–7 to select ringtones for other types of calls.
- 9 Press **OK** .

DID YOU KNOW? You can add, preview, delete, and send sounds on your smartphone. You can also set sounds for messaging notifications and calendar reminders. See [Selecting Sounds & Notifications](#).

Adjusting call and ringer volume

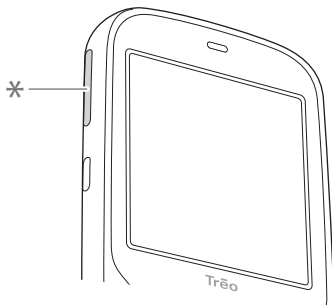

* Volume

Call volume: While a call is in progress, press **Volume** (on the side of your smartphone) to adjust the call volume.

Ringer volume: When a call is not in progress and you are not playing music or a video, press **Volume** to adjust ringer volume.

TIP To turn off the call or ringer volume completely, press and hold **Volume** until the minimum volume is reached. Release the button, wait two seconds, and then press **Volume** again.

Assigning a caller ID ringtone

- 1 On your Today screen, press **Contacts** (left softkey).
- 2 Highlight the contact's name.
- 3 Press **Menu** (right softkey) and select **Edit**.
- 4 Select **Ring tone**.
- 5 Select a tone for this contact entry.
- 6 Press **OK** .



Enabling TTY

You can enable your smartphone for use with a TTY/TDD device. A TTY (also known as a TDD or Text Telephone) is a telecommunications device that enables telephone communication for people who are deaf or hard of hearing, or who have speech or language disabilities.



Your smartphone is compatible with select TTY devices. You can connect a TTY/TDD machine, headset, or hands-free kit to your smartphone through the headset jack while in TTY/TDD mode. Please check with the manufacturer of your TTY device for connectivity information. Be sure that the TTY device supports digital wireless transmission.

NOTE Not all wireless service providers support the TTY feature on your smartphone. Check with your wireless service provider for information.

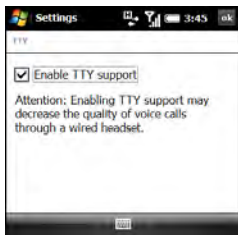

BEFORE YOU BEGIN Make sure your smartphone is connected to a TTY/TDD device using the headset jack. When you enable TTY, all audio modes are disabled on your smartphone, including holding the smartphone up to your ear and listening.

- 1 Press **Start**  and select **Settings**.
- 2 On the Personal tab, select **TTY** .



- 3 Check the **Enable TTY support** box.
- 4 If an alert appears, press **OK** .
- 5 Press **OK** .

Setting your phone to automatically answer calls

- 1 Press **Start**  and select **Settings**.
- 2 On the Personal tab, select **Phone** .
- 3 Select the **More** tab.

TIP On the Phone settings screen, press **Down** on the 5-way to move the highlight to the tab area, and then press **Right** until the More tab appears.



- 4 Check the **Answer incoming calls without pressing Talk after X rings** box and select the number of rings.



- 5 Press **OK** .

Adding contact numbers from new callers

By default, you are prompted to add contact entries for numbers that are not already in your Contacts list. You can turn this feature on or off.

- 1 Press **Start**  and select **Settings**.
- 2 On the Personal tab, select **Phone** .
- 3 Select the **Advanced** tab and check or uncheck the **Add new phone number to Contacts at end of call** box.



- 4 Press **OK** [OK].

Setting options for rejecting a call

By default, when you reject an incoming call, the caller is sent to voicemail. You can change this setting so that, in addition to sending the caller to voicemail, a text message opens addressed to the caller, containing default text, that you can send right away. You can also change the default text of the message.

- 1 Press **Start** [Start] and select **Settings**.
- 2 On the Personal tab, select **Phone** [Phone].
- 3 Select the **Advanced** tab.
- 4 To turn on the text message feature, check the **Reject call with text message** box.





- 5 (Optional) To change the content of the message, select the text in the box, and enter the text you want.
- 6 Press **OK** [OK].

Blocking calls

You can block (bar) incoming or outgoing calls. Not all wireless service providers support the call barring features.

BEFORE YOU BEGIN

- Make sure that call barring is supported by your service plan. Check with your wireless service provider for more information.
- Get a call barring password from your wireless service provider.

- 1 Press **Start**  and select **Settings**.
- 2 On the Personal tab, select **Phone** .
- 3 On the Services tab, highlight **Call Barring** and select **Get Settings**.
- 4 Select the **Block incoming calls** list, and then select one of the options:

All calls: All incoming calls are blocked.

When roaming: All incoming calls are blocked when roaming.

Off: No incoming calls are blocked.

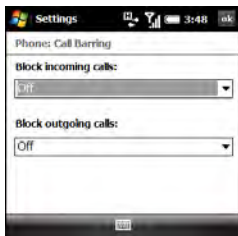



- 5 Select the **Block outgoing calls** list, and then select one of the options:
All calls: All outgoing calls are blocked.



International: All outgoing international calls are blocked.

International except to home country: All outgoing international calls are blocked except to the country where the phone is based.

Off: No outgoing calls are blocked.

- 6 Press **OK** .
- 7 Enter the call barring password and press **OK** .

Setting caller ID



- 1 Press **Start**  and select **Settings**.
- 2 On the Personal tab, select **Phone** .
- 3 On the Services tab, highlight **Caller ID** and select **Get Settings**.
- 4 Select the appropriate option to provide your caller ID to **Everyone** or **No one**, or **Only to contacts**.



- 5 Press **OK** .

Setting call waiting notification

You can choose to be notified when you receive a call while you are on a call. You can choose to accept the call or not. See [Answering a second call \(call waiting\)](#).

- 1 Press **Start**  and select **Settings**.
- 2 On the Personal tab, select **Phone** .
- 3 On the Services tab, highlight **Call Waiting** and select **Get Settings**.

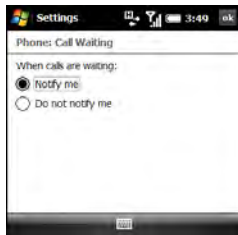

- 4 Select the appropriate option to receive a notification or not.



- 5 Press **OK** .

Changing your voicemail and text message service center number

If your wireless service provider changes the number you call to retrieve voicemail messages, you can change the number on your smartphone. You can also change the number of your text message service center.

- 1 Press **Start**  and select **Settings**.
- 2 On the Personal tab, select **Phone** .
- 3 On the Services tab, highlight **Voice Mail and Text Messages** and select **Get Services**.

- 4 Select the field for the number you want to change, and enter the new number

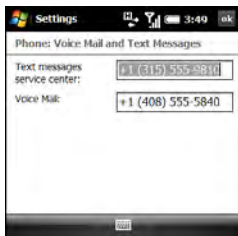

- 5 Press **OK** .



Enabling fixed dialing

Fixed dialing allows you to restrict your outgoing calls and messages to selected phone numbers included in your fixed dialing list. After the service is activated, you can call and send messages only to the phone numbers from the list.

The list is protected by a PIN2 code. If you enter an incorrect PIN2 more times than allowed by your wireless service provider, the SIM card locks. After the SIM card locks, you need the PUK2 to unlock the SIM card. Contact your wireless service

provider for more information and your PIN2.

BEFORE YOU BEGIN Get your PIN2 from your wireless service provider. If you have entered your PIN2 incorrectly and your SIM card is locked, obtain your PUK2 from your wireless service provider.

- 1 Press **Start**  and select **Settings**.
- 2 On the Personal tab, select **Phone** .
- 3 Select the **More** tab.
- 4 Next to **Fixed Dialing**, select **Settings**.
- 5 Check the **Enable fixed Dialing** box.



- 6 Enter your PIN2 and press **Done** (left softkey). If your SIM card is locked, enter your PUK2 and press **Done** (left softkey).
- 7 Press **Menu** (right softkey) to add, delete, or edit the phone numbers in the list.
- 8 Press **OK** [OK].

TIP If your wireless service provider changes the PIN2 code, you need to change it on your smartphone. Press **Start** and select **Settings**. On the Personal tab, select **Phone**. Select the **PIN2** tab, and then select **Change PIN2**.

Manually selecting your wireless band

IMPORTANT The wireless band setting is preset for optimum performance. Do not change this setting unless instructed to do so by a representative from your wireless service provider.

- 1 Press **Start** [Start] and select **Settings**.
- 2 On the Personal tab, select **Phone** [Phone].
- 3 Select the **Band** tab.

- 4 Select the **Select your network type** list, and then select one of the following:

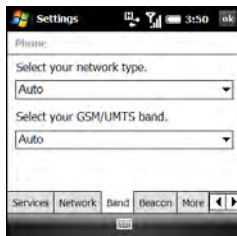

Auto: Automatically selects a network.



GSM: Connects only to GSM networks.

UMTS: Connects only to UMTS (3G or HSDPA) networks.

- 5 Select the **Select your GSM/UMTS Band** list, and then select either **Auto** or one of the bands listed. The band options differ depending on your wireless service provider.
- 6 Press **OK** [OK].

Manually selecting your network settings

IMPORTANT The network settings are preset for optimum performance. Do not change these settings unless instructed to do so by a representative from your wireless service provider. The network settings options vary according to your wireless service provider.

- 1 Press **Start**  and select **Settings**.
- 2 On the Personal tab, select **Phone** .
- 3 Select the **Network** tab.
- 4 To switch to another network, select **Find Network** and select an available network.
- 5 From the **Network Selection** list, select an option:



Automatic: The network connection is automatically made.

Manual: Network connections are manually made. If you are manually selecting a network, select a network from the list of available networks.



- 6 To change your preferred network, select **Set Networks**, check the box next to the networks you want, and select your order of preference.
- 7 Press **OK** .

Selecting broadcast channel options

Broadcast channel settings let you set options for incoming system messages from your wireless service provider.

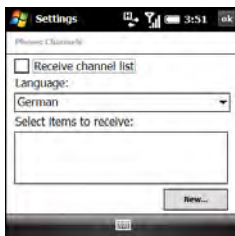
- 1 Press **Start**  and select **Settings**.
- 2 On the Personal tab, select **Phone** .
- 3 Select the **More** tab.
- 4 Under Broadcast Channels, check the **Enable** box and select **Settings**.
- 5 Check the **Receive channel list** box.



- 6 Select the **Language** list, and then select the language in which you want to receive channel messages.
- 7 Select the **Select items to receive** list, and then select the type of messages you want to receive. To create new items, select **New**, enter the item name and channel number, and press **OK** .
- 8 Press **OK** .



Synchronizing information

Synchronizing means that information that has been entered or updated in one place—your Palm® Treo™ Pro smartphone, your computer, or your corporate server—is automatically updated in the other. There's no need to enter information twice. Some types of synchronization can happen on an automated schedule, so you don't even have to think about it.

After you get into the habit of synchronizing regularly, you'll know what a powerful tool synchronization is for transferring, updating, and backing up large amounts of information on your smartphone.

Benefits

- Quickly enter and update information on your computer and your smartphone
- Send photos and videos to your smartphone from your desktop computer
- Protect your information

In this chapter

Synchronization overview	85
How do I synchronize?	85
What can I synchronize?	86
Setting up your computer for synchronization	89
Synchronizing using the USB cable	94
Setting up wireless synchronization	95
Other ways to synchronize	100
Changing which applications sync	102

Synchronization overview

This chapter discusses using desktop sync software and other methods to synchronize your smartphone and your computer.

When you synchronize, info you enter on your smartphone, your computer, or your corporate server is automatically updated in the other location. There's no need to enter the info twice. This is true whether you sync with your computer using desktop synchronization software (see [Setting up your computer for synchronization](#)) or wirelessly with your company's Exchange server using Microsoft Exchange ActiveSync (see [Setting up wireless synchronization](#)).

How do I synchronize?

There are a number of ways to make synchronization occur. You can install

desktop sync software on your computer to synchronize in one of several ways, or you may be able to synchronize wirelessly with an Exchange server. You can also maximize your sync options and sync with both an Exchange server and desktop sync software.

Synchronizing with desktop sync software

The sync application on your smartphone is called ActiveSync. The name of the desktop sync software on your computer depends on your computer's operating system.

Windows XP: The desktop sync software is called ActiveSync® desktop software.

Windows Vista: The desktop sync software is called Windows Mobile Device Center.

You install the software by connecting your smartphone to your computer. You must install this software even if you have already installed a previous version of desktop sync software. See [for instructions](#).

After you install desktop sync software, you can synchronize by connecting your smartphone to your computer using any of the following:

USB cable: See [Synchronizing using the USB cable](#).

Bluetooth® wireless technology: See [Synchronizing over a Bluetooth connection](#).

Infrared (IR): See [Synchronizing over an infrared connection](#).

Synchronizing wirelessly with the server

You can set up your smartphone to synchronize email and other information wirelessly with Microsoft Exchange Server 2007 or Exchange Server 2003 using Microsoft Exchange ActiveSync (see [Setting up wireless synchronization](#)). If you choose this method, synchronization takes place automatically after setup.

NOTE If you decide to sync wirelessly, you don't have to install the desktop sync software, but we strongly recommend that you do. You need the desktop sync software to synchronize pictures, videos, music files, and other info directly with your computer.

What can I synchronize?

If you have Microsoft Office Outlook® 2003 or later installed on your computer, you can synchronize information in these applications:

 Contacts

 Calendar

 E-mail

 Tasks

The information in these applications synchronizes with Outlook by default whether you use desktop sync software or wireless synchronization with Microsoft Exchange ActiveSync.

TIP If you don't have Outlook installed on your computer, you can download a trial version of Outlook 2007. On your smartphone, press **Start** and select **Settings**. Select the **System** tab, select **PC Setup**, and then select **Set up my PC**. Connect your smartphone to your computer using the USB cable. On the screen that appears on your computer, select the link to download a trial version of Outlook 2007.

If you set up synchronization with desktop sync software, information in the Favorites application is synchronized by default as well.

DID YOU KNOW? Synchronizing Favorites gives you an easy way to get favorites from the web browser on your computer into the web browser on your smartphone. Just add them to the folder called Mobile Favorites, which shows up in your computer's browser. When you sync, they become available on your smartphone as well. Backup copies of any favorites that you add on the smartphone browser are also stored in the Mobile Favorites folder.

You can remove applications or add others to the list of applications that synchronize. For example, you can change settings to synchronize Word, Excel, PowerPoint, OneNote, and PDF files, as well as pictures, music, videos, and other types of files (see [Changing which applications sync](#)). If you want to synchronize music or other files that appear in the Windows Media Player Mobile library on your smartphone (see [Windows Media Player Mobile](#)), you need Windows Media Player 10 or later on your computer.

TIP If you don't have Windows Media Player installed on your computer, you can download it for free from microsoft.com.

If you want to synchronize with a personal information manager (PIM) other than Microsoft Office Outlook, you must install a third-party solution. Contact the PIM's vendor to learn if software is available for your smartphone.

This table lists the types of info you can synchronize and the methods to use.

Info type	Method	Where to learn more
Outlook Contacts, Calendar, Tasks	Desktop sync software (sync with computer) <i>or</i> Exchange ActiveSync (direct sync with server)	<u>Setting up your computer for synchronization</u> <i>or</i> <u>Setting up wireless synchronization</u>
Outlook Email	Desktop sync software <i>or</i> Exchange ActiveSync	<u>Setting up your computer for synchronization</u> <i>or</i> <u>Setting up wireless synchronization</u>
Word, Excel, PowerPoint, OneNote, PDF files	Desktop sync software	<u>Setting up your computer for synchronization</u> <u>Synchronizing your Microsoft Office files</u> <u>Changing which applications sync</u>
Music, video, and picture files that are in your Windows Media Player Mobile library	Desktop sync software <i>and</i> Windows Media Player	<u>Setting up your computer for synchronization</u> <u>Changing which applications sync</u> <u>Synchronizing Windows Media Player library files</u>

Info type	Method	Where to learn more
Music, picture, and video files that are not in your Windows Media Player Mobile library	Desktop sync software	Setting up your computer for synchronization Changing which applications sync Synchronizing Windows Media Player library files (Windows Vista)
Outlook Notes	Desktop sync software	Setting up your computer for synchronization Changing which applications sync
Files to be transferred to an expansion card	Desktop sync software	Setting up your computer for synchronization Changing which applications sync

Setting up your computer for synchronization

Before you can synchronize with your computer, you must have the current version of the desktop sync software installed.

System requirements

Your computer must meet the following minimum system requirements:

- Windows XP Service Pack 2 or Windows Vista (later versions may also be supported)
- 32MB of available memory (RAM)
- 170MB of free hard disk space
- Available USB port

- USB cable (included with your smartphone)
- Adobe Flash Player (required to run the installation program)

TIP If you do not have Adobe Flash Player on your computer, you can download it for free from adobe.com.

Installing the desktop sync software

NOTE If you're transferring info from a previous Windows Mobile® device or from a Palm OS® by ACCESS device, you can learn more about how to move content, such as pictures, music, and files, to your smartphone by going to palm.com/teoproumts-support.

You need the USB cable that came with your smartphone to install the desktop sync software. The cable connection between your smartphone and your computer can operate in two modes: setup mode and sync mode. The first time you connect your smartphone to your computer, the connection is automatically set to setup mode, so that you can complete installation.

In setup mode, you can do the following:

- Install the desktop sync software.
- Download a trial version of Outlook 2007.
- Download a copy of this *User Guide* to your computer.
- Visit Palm support online.

BEFORE YOU BEGIN If you are installing the software on a computer at work, make sure your company allows you to install new software. Contact your company's IT department for help.

- 1 Close any applications that are currently running on your computer, including those running in the background. Your computer must have all its resources available to install the software.
- 2 Plug the USB cable into an available USB port on your computer or into a powered USB hub connected to your computer.

TIP For best performance, plug your USB cable directly into a USB port on your computer. If your computer has USB ports on both the front and back, we suggest using the back port. If you use a USB hub, make sure it's a powered hub.

- 3 Connect the USB cable to your smartphone by inserting it into the microUSB connector on the bottom of the smartphone.

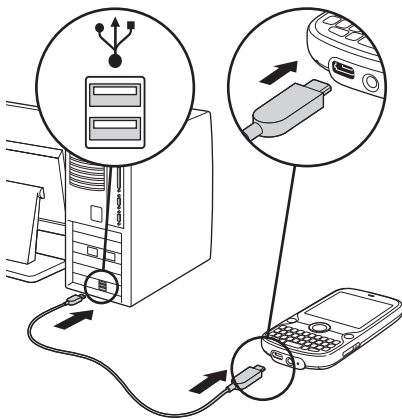

When you connect your smartphone to your computer in setup mode, an application checks to see if your computer has the current version of the desktop sync software installed.

If your computer has the current version of the software installed, the mode switches to sync mode, and you are ready to sync. You can sync now by clicking **Sync your PC and Treo**, or simply reconnect your smartphone and your computer to sync in the future (see [Synchronizing using the USB cable](#)).

If your computer doesn't have the current version of the sync software installed, go to the next step.

- 4 On your computer, select **Install sync software on your PC** and follow the installation instructions that appear on both your computer and your smartphone. If prompted on a Windows Vista computer, click **Continue**.

TIP Your smartphone is being charged when it is connected to your computer using the USB cable. If you never want to sync through this connection, but only charge your smartphone, you need to turn off setup mode. When the Setup screen appears on your computer, on your smartphone, press **Cancel** (right softkey), and then press **Exit** (right softkey).

- 5 After you complete installation, the mode switches to sync mode, and you are ready to sync. You can sync now by clicking **Sync your PC and Treo**, or simply reconnect your smartphone and your computer to sync in the future (see [Synchronizing using the USB cable](#)).



Desktop software installation also creates a folder for your smartphone on your computer. When your smartphone is connected to your computer, opening My Computer or Windows Explorer (Windows XP) or Computer (Windows Vista) displays an icon representing your smartphone. Double-clicking this icon displays folders containing items you synchronized, such as music files, pictures, and videos.

Switching between setup mode and sync mode

After the first time you connect your smartphone to your computer, the connection switches from setup mode to sync mode. In sync mode, your smartphone synchronizes with your computer every time you connect them using the USB cable, provided you have the current version of the desktop sync software installed on your computer.

The connection stays in sync mode unless you manually switch it to setup mode. For example, you may be using sync mode but decide you want to download the trial version of Outlook 2007, so you need to switch to setup mode. After you finish working in setup mode, the connection automatically switches back to sync mode—you don't need to do anything.

IMPORTANT Even if you are in sync mode, synchronization cannot take place unless you have the desktop sync software installed on your computer. If you did not install the software during initial setup but want to synchronize, switch to setup mode so that you can install the software.

- 1 On your smartphone, press **Start**  and select **Settings**.
- 2 Select the **System** tab, and then select **PC Setup** .
- 3 Select **Set up my PC**.
- 4 Press **OK** .
- 5 Connect your smartphone to your computer to run Setup.

Using the desktop sync software

After you install the desktop sync software, synchronization happens by default anytime you connect your smartphone to your computer, as described in [Synchronizing using the USB cable](#). You can also open the desktop sync software window on your computer to perform the following tasks:

- Install applications from your computer to your smartphone (see [Installing applications from your computer](#)) or to an expansion card inserted into the expansion card slot on your smartphone (see [Installing applications onto an expansion card](#)).
- Change which applications synchronize.
- In ActiveSync desktop software on a Windows XP computer, enter settings to synchronize wirelessly with Microsoft Exchange Server 2003 or 2007.

DID YOU KNOW? You can also change which applications synchronize (see [Changing which applications sync](#)) and enter settings to synchronize wirelessly (see [Setting up wireless synchronization](#)) in the ActiveSync app on your smartphone. Whether you enter changes on your smartphone or on your computer, the changes are transferred to the other location the next time you synchronize.

To open the desktop sync software, do one of the following:

Windows XP: To open the ActiveSync desktop software window, double-click the **ActiveSync**  icon in the taskbar in the lower-right corner of your computer screen.

TIP If the ActiveSync icon does not appear in the taskbar, click **Start > Programs > Microsoft ActiveSync** to open the ActiveSync window.

TIP You can enter a setting to have the ActiveSync window open automatically when you connect your computer and your smartphone. In the ActiveSync window, select **File > Connection Settings**, and check the **Open ActiveSync when my device connects** box.



Windows Vista: To open Windows Mobile Device Center, click **Start > All Programs > Windows Mobile Device Center**.

Synchronizing using the USB cable

After you install the desktop sync software (see [Installing the desktop sync software](#)), every time you connect your smartphone to your computer, the desktop sync software automatically turns on and checks

whether changes you made on the computer or on the smartphone need to be synchronized.

Synchronizing

NOTE If you synchronize more than one device with the same computer, each device must have a unique name. To create a custom device name for your smartphone, press **Start**  and select **Settings**. Select the **System** tab, and then select **About** . Select the **Device ID** tab and enter a name and description.



- 1 Plug the USB cable into an available USB port or into a powered USB hub on your computer.
- 2 Connect the USB cable to your smartphone by inserting it into the microUSB connector on the bottom of the smartphone.



- If you don't see the correct icon, make sure the desktop sync software that came with your smartphone is running on your computer.
- If you have any problems synchronizing, see [Synchronization](#) for troubleshooting suggestions.

TIP Your smartphone contains Sprite Backup, a backup and restore application that backs up information that is not synchronized with Outlook. This app also preserves your information and settings if your smartphone is ever lost or stolen, and it protects your info during a hard reset. To access this app, press **Start**, select **Programs**, and then select **Sprite Backup**.

3 Check for synchronization progress:

Windows XP: Look for the animated **ActiveSync**  icon at the top of your smartphone screen and the **ActiveSync**  icon in the taskbar on your computer.

Windows Vista: Look for the animated **connection**  icon at the top of your smartphone screen.

Setting up wireless synchronization

Does your company use Microsoft Outlook as its email solution? Does your company also use Microsoft Exchange Server 2003 or 2007 as its email server? If so, you may be able to wirelessly synchronize the email and other Outlook info on your smartphone

and the same info stored on the Exchange server using Microsoft Exchange ActiveSync.

If you are using Exchange Server 2007, or Exchange Server 2003 that has been upgraded to Service Pack 2, you may be able to take advantage of the additional features of Microsoft Direct Push. Microsoft Direct Push is a two-way wireless delivery method that keeps your Outlook information always up-to-date and provides more efficient communication between the server and your smartphone. It includes features like Global Address List, Tasks Over The Air (OTA), and IP-based push updating of Calendar and Messaging.



DID YOU KNOW? Because your desktop copy of Outlook also syncs with the server, whatever is synchronized to the server from your smartphone also shows up in Outlook on your computer; and whatever you enter or change in Outlook on your computer syncs to the server and then shows up on your smartphone.

BEFORE YOU BEGIN To synchronize wirelessly, you need to set up an Exchange

Server account. Work with your system administrator to gather the following info, and then follow the steps in this section to set up an account:

- Mail server address and domain name.
- The username and password you use to access your corporate mail server.
- Security connection: Does your server use an encrypted (SSL) connection?
- Security measure: Is it OK to store your corporate email password on your smartphone?

TIP If you installed ActiveSync desktop software on a Windows XP computer, you may have already set up your smartphone to synchronize wirelessly with the server. To check, press **Start**, select **Programs**, and then select **ActiveSync**. Press **Menu** (right softkey). If Configure Server appears instead of Add Server Source, wireless sync is already set up, and you can skip this procedure.

- 1 Press **Start**  and select **Programs**.
- 2 Select **ActiveSync** .
- 3 Press **Menu** (right softkey) and select **Add Server Source**.

- 4 Enter the email address you use to access email from your corporate Exchange server. Check the box to have the setup process get your Exchange server settings from the Internet.
- 5 Press **Next** (right softkey).
- 6 Enter the username and password you use to access your corporate mail server, and enter the Exchange server domain.

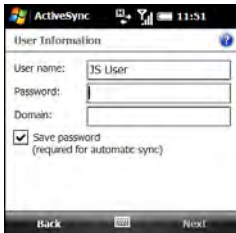

NOTE You can't see your password as you enter it, so be careful. Be sure Caps Lock and Option Lock are not on unless you need them. For info on how to enter characters, see [Entering lowercase and uppercase letters](#) and [Entering numbers, punctuation, and symbols](#).

TIP The Exchange server settings are case-sensitive. Be sure to enter uppercase and lowercase letters properly.

- 7 Check the **Save password** box.

TIP If you found out from your system administrator that it is not OK to store your corporate email password on your smartphone, don't check the **Save password** box; you must synchronize manually (see [Initiating a wireless sync manually](#)).

- 8 Press **Next** (right softkey).
- 9 If prompted, enter the server address. Check the **This server requires an encrypted (SSL) connection** box if your server uses an encrypted connection.

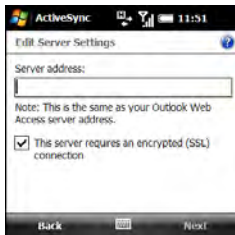

- 10** Press **Next** (right softkey) and check the boxes for the types of information you want to synchronize with the Exchange server.



- 11** (Optional) Highlight an item and select **Settings** to change the synchronization settings for that type of information. Settings are not available for all items.

TIP To automatically download more of an incoming email message than the default setting, select **E-mail** in step 11 and select a higher number from the **Download size limit** list. If you don't increase this setting, you can manually download the rest of the message at your convenience.

TIP To set the rules for fixing sync conflicts, press **Menu** (right softkey) and select **Advanced**.

- 12** Press **Finish** (left softkey).

Synchronization with your Exchange server begins automatically. A status bar appears onscreen indicating sync progress.

You can set a schedule for synchronization to take place anytime info is updated on either your smartphone or the server or at certain intervals (see [Setting the synchronization schedule](#)), or allow synchronization to take place only when you initiate it manually (see [Initiating a wireless sync manually](#)).



Setting the synchronization schedule

You can set a synchronization schedule in either of the following situations:

If you use Microsoft Exchange Server 2007, or Microsoft Exchange Server 2003 with Service Pack 2: By default, wireless sync takes place anytime info is updated on either your smartphone or the server using Microsoft Direct Push. To save battery life, however, you can set synchronization to take place at intervals that you specify.

If you use Microsoft Exchange Server 2003 that is not upgraded to Service Pack 2:

By default, wireless sync does not take place automatically. Set a synchronization schedule to have sync take place either anytime info is updated on your smartphone or the server, or at certain intervals.

- 1 Press **Start**  and select **Programs**.
- 2 Select **ActiveSync** .
- 3 Press **Menu** (right softkey) and select **Schedule**.

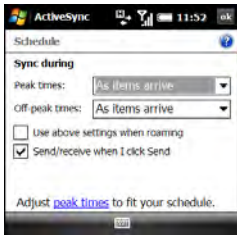

- 4 Set any of the following options:

Peak times: Sets the frequency for high-traffic time periods such as when you are at work or when email volume is high.

Off-peak times: Sets the frequency for low-traffic time periods such as late at night.

Use above settings when roaming:

Sets the frequency while you are roaming outside your wireless service provider's network. You should keep this box checked to ensure that wireless sync works properly.



Send/receive when I click Send: Sets whether items are sent as soon as you select Send in the Messaging application, or whether they are held until the next synchronization.

- 5 Press **OK** .

Initiating a wireless sync manually

If you want to control exactly when a wireless sync takes place, or if it is not OK to store your corporate email password on your smartphone, you can initiate sync manually.

- 1 To set up manual sync, follow the preceding procedure, [Setting the synchronization schedule](#). In the Peak times and Off-peak times lists, select **Manually**.





- 2 To initiate a manual sync, press **Start**  and select **Programs**.
- 3 Select **ActiveSync** .
- 4 Press **Sync** (left softkey).



Other ways to synchronize

Synchronizing over a Bluetooth connection

You can synchronize your computer and smartphone using Bluetooth wireless technology.

BEFORE YOU BEGIN Make sure your computer is equipped with Bluetooth wireless technology. You may need to go to your computer manufacturer's website to download required software. Check the documentation that came with your computer for information.

- 1 Do one of the following:
Windows XP: On your computer, right-click the **ActiveSync**  icon in the taskbar in the lower-right corner of the screen, and select **Connection Settings**.
Windows Vista: Click **Start > All Programs > Windows Mobile Device Center**. Select **Connect without setting up your device**, and then select **Connection settings**.
- 2 Check the **Allow connections for one of the following** box and select **Bluetooth**.
- 3 On your smartphone, press **Start**  and select **Settings**.
- 4 Select the **Connections** tab, and then select **Bluetooth** .
- 5 Select the **Mode** tab and check the **Turn on Bluetooth** box.
- 6 Press **Start**  and select **Programs**.
- 7 Select **ActiveSync** .
- 8 Press **Menu** (right softkey) and select **Connect via Bluetooth**.

- 9 If this is the first time you're making a Bluetooth connection to this computer, follow the onscreen prompts to set up a Bluetooth partnership with this computer. See [Connecting to devices with Bluetooth® wireless technology](#) for more information on partnerships.
 - 10 Select **Sync**.
 - 11 When synchronization has finished, press **Menu** (right softkey) and select **Disconnect Bluetooth**.
- 1 Set up your computer to receive infrared beams. See ActiveSync Help on your computer for details.
 - 2 Point the IR port directly on your smartphone at your computer's IR port.
 - 3 On your smartphone, press **Start**  and select **Programs**.
 - 4 Select **ActiveSync** .
 - 5 Press **Menu** (right softkey) and select **Connect via IR**.
 - 6 Select **Sync**.

Synchronizing over an infrared connection

If your computer has an IR (infrared) port, you can synchronize with your computer wirelessly using the IR port on your smartphone.

BEFORE YOU BEGIN

- Make sure your computer is equipped with an IR port.
- Turn on the feature to receive beamed information on your smartphone (see [Turning on the option to receive beamed information](#)).

Synchronizing with multiple computers

You can set up your smartphone to synchronize with up to two computers as well as with Exchange Server 2003 or 2007. When synchronizing with multiple computers, the items that you synchronize appear on all the computers.

For example, if you set up to sync your smartphone with two computers named C1 and C2, when you sync Contacts and Calendar on your smartphone with both computers, you get the following results:



- The contacts and calendar appointments that were on C1 are now also on C2.

- The contacts and calendar appointments that were on C2 are now also on C1.
- The contacts and calendar appointments from both computers are on your smartphone.

NOTE Microsoft Office Outlook® email can synchronize with only one computer.

Changing which applications sync

You must select sync options if you want to synchronize notes, pictures, and other types of files.

- 1 Press **Start**  and select **Programs**.
- 2 Select **ActiveSync** .
- 3 Press **Menu** (right softkey) and select **Options**.



- 4 Do any of the following:
 - Check the box next to any items you want to synchronize. If you cannot check a box, you might have to uncheck a box for the same information type elsewhere in the list.
 - Uncheck the box next to any items you want to stop synchronizing.

TIP To end the sync relationship between your smartphone and a computer so that items are no longer synchronized with that computer, select the computer name on the ActiveSync screen on your smartphone, and then select **Delete**.



- Highlight an item and select **Settings** to customize the settings for that item. Settings are not available for all items.

For detailed information on synchronizing Word documents, Excel spreadsheets, and PowerPoint presentations, see [Synchronizing your Microsoft Office files](#).

For detailed information on synchronizing pictures, videos, and music files, see [Synchronizing your pictures, videos, and music](#). For information on changing email sync options, see [Changing email download settings: Outlook email accounts](#).

Stopping synchronization

If you ever need to manually stop a synchronization that's in progress, follow these steps:

- 1 Press **Start**  and select **Programs**.
- 2 Select **ActiveSync** .
- 3 Press **Stop** (left softkey).



Your email

You already know how efficient email is for staying in touch. Now your Palm® Treo™ Pro smartphone brings you a new level of convenience: email on the go. Enjoy the ease and speed of communicating with friends, family, and colleagues anywhere you can access your wireless service provider's data network.

You can send photos to your friends and family, or create Microsoft Word or Excel files and send them to your colleagues. You can also receive attachments to view and edit at your convenience.

Benefits

- Receive photos, sound files, Word and Excel files, and more
- Attach and send files of almost any type
- Save messages from your computer to view at a convenient time

In this chapter

Setting up email	107
Sending and receiving messages	115
Working with email messages	120
Customizing your email settings	126
Working with meeting invitations	134
Sending email messages from within another application.	135

Setting up email

BEFORE YOU BEGIN

- Before you use your smartphone to send or receive messages, consult your wireless service provider for pricing and availability of email services and data rate plans.
- Make sure your phone is on and you're inside a coverage area before you send or receive messages.
- If you want delivery of Microsoft Office Outlook® email using Microsoft Direct Push, make sure that your IT organization uses Exchange Server

2007, or Exchange Server 2003 with Service Pack 2.

Entering settings for an email account

You can use the Messaging application on your smartphone to access the many kinds of email you may use: corporate, ISP, and web-based (like Gmail and Yahoo! Mail). Before you can send and receive email on your smartphone, you need to decide which type of email account you want to access. The setup process is different for each email account type, so it is very important that you select the correct type to send and receive email.

Email account type	Type of email you can access	How to set up
POP/IMAP	You can obtain email from an ISP or Internet email account such as AOL, or from a small business or corporate Internet email account.	See Setting up a POP/IMAP account in the Messaging application: Common email providers or Setting up a POP/IMAP account in the Inbox application: Other email providers .

Email account type	Type of email you can access	How to set up
Microsoft Exchange Server	You can retrieve corporate email using a Microsoft Exchange server. You can access email wirelessly if your company is using Microsoft Exchange ActiveSync®.	See Setting up wireless synchronization . You may need to check with your IT organization to ensure that Exchange ActiveSync® is supported and to obtain the configuration settings.
Hotmail	You can use Windows Live to access mail from your web-based Hotmail account. NOTE Windows Live is not supported by all wireless service providers.	See Using Windows Live™ .
Free web-based email	You can access mail from Yahoo! and other free web-based systems.	Access the email website directly using your smartphone's web browser.

DID YOU KNOW? Some web-based email providers such as Yahoo! and Gmail allow you to configure your email account so that you can access it from the Messaging application on your smartphone instead of from your web browser. Check the provider's website for information.

Setting up a POP/IMAP account in the Messaging application: Common email providers

Follow this procedure if you have a common email provider, for example, AOL, EarthLink, or Yahoo!. If you are setting up the Messaging application to work with your corporate email account, or you have a

less common email provider, see [Setting up a POP/IMAP account in the Inbox application: Other email providers](#).

BEFORE YOU BEGIN Ask your email provider or system administrator for your account username and password if you don't know them.

- 1 Press **Messaging** .
- 2 Select **Setup E-mail**.
- 3 Enter the email address that you want to set up, and enter your password for this account.



- 4 If you want your password entered automatically, check the **Save password** box. If you want to enter

your password each time you access this account, do not check this box.

DID YOU KNOW? Checking the **Save password** box makes it easier to check your email, because you don't have to enter your password each time. Leaving the box unchecked keeps your email more secure, because no one can download messages without entering your password.

- 5 Press **Next** (right softkey).
- 6 If the setup process finds your account settings, press **Next** (right softkey).
If a screen appears displaying an option to try to get email settings automatically from the Internet, see [Setting up a POP/IMAP account in the Inbox application: Other email providers](#) and continue with step 5 of that procedure.
- 7 Enter your name and, if you want, change your account display name to something meaningful. For example, if this is your work email account, you can change the display name to "Work" or your company's name.



- 8 Press **Next** (right softkey).
- 9 (Optional) Select either of the following:

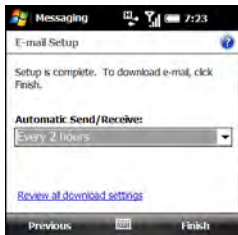

Automatic Send/Receive: Set the time interval for automatically sending and receiving email, from every 5 minutes to once a day. If you do not want to automatically download messages, select **Manually**.

TIP To maximize battery life and minimize data charges, set a less frequent interval for sending and receiving email.

Review all download settings: Select this option to change download settings. See [Changing email download settings: Other email accounts](#) for information.

- 10 Press **Finish** (right softkey). If prompted, select **OK** to download messages for this account now.

Setting up a POP/IMAP account in the Inbox application: Other email providers

You can set up an account in the Messaging application to send and receive email messages using an email account that you have with an Internet service provider (ISP), an email account that you access using a VPN server connection (such as a work account; see [Connecting to a VPN](#)), or any other IMAP or POP email account.

BEFORE YOU BEGIN Work with your email provider or system administrator to gather the following info:

- Account type (POP3 or IMAP).
- Mail server name for receiving mail.
- Your username and password.
- Any special security requirements.
- Password security: Find out whether it's OK to store your corporate email password on your smartphone.
- Mail server name for sending mail.

- 1 Press **Messaging** .
- 2 Select **Setup E-mail**.
- 3 Enter the email address that you want to set up, and enter your password for this account.



- 4 If you want your password entered automatically, check the **Save password** box. If you want to enter your password each time you access this account, do not check this box.

DID YOU KNOW? Checking the **Save password** box makes it easier to check your email, because you don't have to enter your password each time. Leaving the box unchecked keeps your email more secure, because no one can download messages without entering your password.

- 5 If a screen appears with a message that the setup process has found your account settings, go to [Setting up a POP/IMAP account in the Messaging application: Common email providers](#) and continue with step 6 of that procedure.

If the following screen appears, check the box if you want the setup process to try to get your account settings from the Internet.

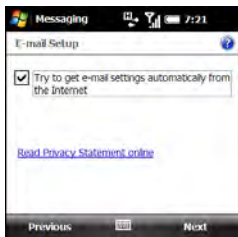

- 6 Press **Next** (right softkey).
- 7 If you did not check the box in step 5 or the setup process does not find account settings, press **Next** (right softkey).
- 8 If prompted, select one of the following as your email provider:

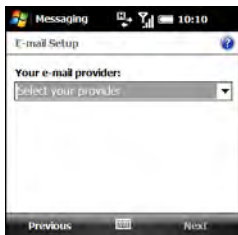

Internet e-mail: Select this option if you access email from any type of email account except a corporate account that uses an Exchange server.

Exchange server: Select this option if you access email from a corporate email account using an Exchange server.

Custom domain: Select this option if the part of your email address after the @ symbol is not the same as your email provider name. For example, select this option if your email address is “user@mycompany.com” but your actual email provider is “live.com.” If you select this option, press **Next** (right softkey) and enter your actual email provider domain name.

- 9 Press **Next** (right softkey).
- 10 Enter your name and, if you want, change your account display name to something meaningful. For example, if this is your work email account, you can change the display name to “Work” or your company’s name.



- 11 Press **Next** (right softkey).
- 12 Enter the name of the incoming mail server.



- 13 Select the **Account type** list, and then select **POP3** or **IMAP4**.

- 14 Press **Next** (right softkey).
- 15 Enter your account username and password.
- 16 If you want your password entered automatically, check the **Save password** box. If you want to enter your password each time you access this account, do not check this box.

DID YOU KNOW? Checking the **Save password** box makes it easier to check your email, because you don't have to enter your password each time. Leaving the box unchecked keeps your email more secure, because no one can download messages without entering your password.

TIP If you found out from your system administrator that it is not OK to store your corporate email password on your smartphone, don't check the **Save password** box.

- 17 Press **Next** (right softkey).
- 18 Enter the name of the outgoing (SMTP) mail server, set whether the server requires authentication, and set whether the server requires you to use your account and password to send email.

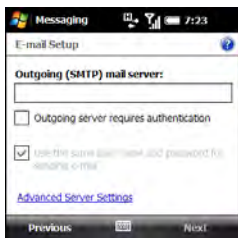

- 19** Select **Advanced Server Settings**, set SSL requirements for incoming and outgoing email, and select the type of connection to use for sending and receiving email.

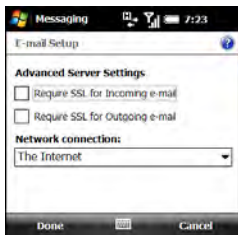

- 20** Press **Done** (left softkey). On the outgoing mail server screen, press **Next** (right softkey).

- 21** (Optional) Select either of the following:

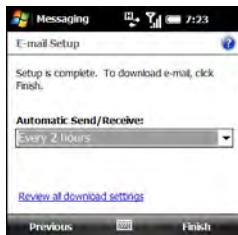

Automatic Send/Receive: Set the time interval for automatically sending and receiving email, from every 5 minutes to once a day. If you do not want to automatically download messages, select **Manually**.

TIP To maximize battery life and minimize data charges, set a less frequent interval for sending and receiving email.

Review all download settings: Select this option to change download settings; see [Changing email download settings: Other email accounts](#) for information.

- 22 Press **Finish** (right softkey). If prompted, select **OK** to download messages for this account now.

DID YOU KNOW? On the Accounts tab in Messaging Options, an asterisk appears next to the account you most recently accessed.

Editing and deleting accounts

NOTE To delete an Outlook Email account, use the ActiveSync application, not the Messaging application. To delete a Hotmail account you set up using Windows Live, use the Windows Live application.

- 1 Press **Messaging** .
- 2 Press **Menu** (right softkey) and select **Options**.
- 3 Do one of the following:



To delete an account: Highlight the account you want, press and hold **Center** , and then select **Delete**.

To edit an account: Select the account, select the account feature you want to edit, and go through the screens to change the settings you want to edit.

Sending and receiving messages

Selecting which email account to use

If you set up more than one email account on your smartphone (see [Setting up email](#)), you can select the account you want to use to view or send messages in one of two ways:

- By default, when you open the Messaging application, a list of all of your email accounts appears. Select the account you want.
- If you turn off the option to display the list of accounts (see [Customizing your email settings](#)), when you open the Inbox application, the last account you were using is displayed. Press **Right**  or **Left**  to cycle through your accounts until the name of the account you want appears in the title bar.



TIP Also press **Right** or **Left** to switch to a different account after you are finished working in the first account you selected.

Creating and sending an email message

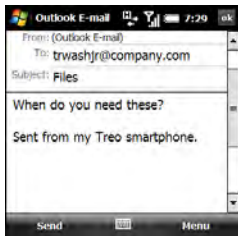
- 1 Press **Messaging** .
- 2 Select the account you want to use to send a message.
- 3 Press **Menu** (right softkey) and select **New**.
- 4 Enter the recipient's email address:



- Enter the first letters of the recipient's first or last name, the first and last initials separated by a space, or the email address. If a match is found in your Contacts list, select the name.
- If the recipient's name is in an online address book, you can find the name and add it. See [Using an online address book](#).



- If the recipient's name and mobile number are not in your Contacts list, enter the full mobile number or email address.
- Separate addresses with semicolons (;). Enter a semicolon by pressing **Option**  + **K**.
- Need to enter an underscore? Press **Alt**  and select the character. It's the second character in the list.

TIP To display the Cc and Bcc address fields, navigate to the To field and press **Up** on the 5-way.

- 5 To confirm that addresses you enter are valid, press **Menu** (right softkey) and select **Check Names**. An alert appears if any names or address you've entered are not valid.
- 6 Select **Subject** and enter a title for the message.
- 7 Press **Down**  to go to the body of the message. Enter your message, or press **Menu** (right softkey) and select **My Text**. Select the phrase you want. To add a new My Text phrase, select **Edit My Text Messages** in the list.

- 8 (Optional) To attach an item to the message, press **Menu** (right softkey) and select **Insert**. Select the type of item you want to attach, and then select the file or record a voice note.

TIP You can send an email message with a file attached from directly within other applications on your smartphone; see [Sending email messages from within another application](#).

- 9 (Optional) Press **Menu** (right softkey) and do one or both of the following:
- Select **Spell Check**. When the spell check is complete, press **OK** .
 - Select **Message Options**. Select the **Priority** list, select a priority setting for the message, and press **OK** .

TIP You can use the Message Options screen to select a language for the message. For certain types of email accounts, you can also set a security level and a permission level.

- 10 Press **Send** (left softkey).

TIP Press **Menu** (right softkey) and select **Save to Drafts** if you need to finish composing your message later.

TIP To save memory on your smartphone, turn off the option to save sent messages in the Saved folder. In the Inbox, press **Menu** (right softkey) and select **Tools > Options**. Select the **Message** tab and uncheck the **Keep copies of sent items in Sent folder** box.

Receiving email messages

How you receive email messages depends on the type of account you are using and how you synchronize:

- If you synchronize wirelessly with your Exchange server using Microsoft Exchange ActiveSync, new email messages are sent to your smartphone when they appear on the server, according to the schedule you set up (see [Setting the synchronization schedule](#)), or when you manually initiate a sync (see [Initiating a wireless sync manually](#)).

TIP If you sync email with Microsoft Exchange Server 2003 or 2007, you can synchronize messages in subfolders you create. In the Inbox, press **Menu** (right softkey) and select **Tools > Manage Folders**. Folders containing subfolders display a +. Select the + to view the subfolders. Check the box to the left of any subfolder you want to sync.

TIP If you synchronize email with Microsoft Exchange Server 2007, and you receive a message containing a link to a document on SharePoint or an internal file server, you can view the document by selecting the link.

- If you use desktop sync software to synchronize your smartphone with your computer, messages in Outlook on your computer are transferred to your smartphone when you connect your computer and your smartphone (see [Connecting your smartphone to your computer](#)).
- For all other types of accounts, including ISP accounts and accounts you access using a VPN server connection (typically a work account; see [Connecting to a VPN](#)), message retrieval depends on the option you chose from the Automatic Send/Receive list during account setup (see [Setting up a POP/IMAP account in the Messaging application: Common email providers](#) or [Setting up a POP/IMAP account in the Inbox application: Other email providers](#)), as follows:
 - If you chose a time interval:** Your smartphone automatically checks for and downloads new messages according to that interval.
 - If you chose Manually:** Follow these steps to send and receive messages:
 - 1 Press **Messaging** .
 - 2 Select the account for which you want to send and receive messages.
 - 3 Press **Menu** (right softkey) and select **Send/Receive** to synchronize your smartphone with your email server.



TIP Partially downloaded messages appear in the message list with a partial envelope icon to the left of the subject. To view the full message, either press **Menu** (right softkey) and select **Download Message**, or open the message and select **Get the rest of this message**. The full message is downloaded the next time you manually or automatically retrieve messages.

DID YOU KNOW? You can view messages sent as HTML with the HTML formatting intact.

DID YOU KNOW? You can receive and open attachments in a number of different formats, including PDF. PDF file attachments open in Adobe Reader LE on your smartphone (see [Adobe® Reader® LE](#)).

TIP To store attachments on an expansion card, insert the card into your smartphone's expansion card slot, press **Menu** (right softkey) and select **Tools > Options**. Select **Storage** and check the **When available, use this storage card to store attachments** box.



Opening attachments

Unread messages containing attachments display this icon  for partially downloaded messages and this icon  for fully downloaded messages. To open an attachment, do one of the following:

For fully downloaded messages: Open the message and select the attachment name.

For partially downloaded messages: Open the message and select **Get the rest of this message**. After the message has been downloaded, select the attachment name to open it.

If you are synchronizing with Outlook on your computer and want to download attachments automatically, do the following:

- 1 Press **Start**  and select **Programs**.
- 2 Select **ActiveSync** .
- 3 Press **Menu** (right softkey) and select **Options**.
- 4 Select **E-mail**, and then select **Settings**.
- 5 Check the **Include file attachments** box.

- 6 (Optional) To automatically download attachments up to a certain size only, check the **Only if smaller than** box and enter the maximum attachment size.
- 7 Press **OK** .

To automatically download attachments from an IMAP4 email account (typically an ISP account) or an account that you access using a VPN server connection (typically a work account; see [Connecting to a VPN](#)), do the following:

- 1 Press **Messaging** .
- 2 Do one of the following:
 - If the account list is displayed:** Press **Menu** (right softkey) and select **Options**.
 - If the message list for a specific account is displayed:** Press **Menu** (right softkey) and select **Tools > Options**.
- 3 On the Accounts tab, select the IMAP4 account name.
- 4 Press **Next** (right softkey) until you reach Server information, and then select **Options**.

- 5 Press **Next** twice, and then select either **Get full copy of messages** and **When getting full copy, get attachments** or **Entire message**, depending on the option displayed.

DID YOU KNOW? Embedded images and objects cannot be received as attachments, unless you have an IMAP4 email account with TNEF disabled. Note that TNEF must be enabled to receive meeting requests.

Working with email messages

Adding a contact from an email message

You can add a contact name or email address to your Contacts list directly from the To, cc, or bcc field of an email message. You can select the name or address from either an outgoing or an incoming message, and you can either create a new contact or add the information to an existing contact.

- 1 In an open message, highlight the name or address of the contact you want to add.
- 2 Press **Center** .
- 3 Press **Save** (left softkey).
- 4 Select **<New Contact>** to create a new contact entry for this name or address, or select an existing contact to add the name or address to that entry.

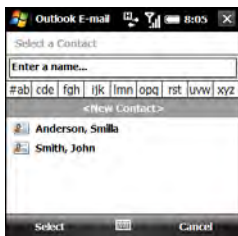

- 5 Enter or edit the contact information.
- 6 Press **Save** (left softkey).

DID YOU KNOW? When you enter or edit a contact phone number from a message, you can insert one or more two-second pauses by pressing **Menu** (right softkey) and selecting **Insert Pause**. You can also insert an indefinite pause that allows you to respond to dialing instructions by pressing **Menu** (right softkey) and selecting **Insert Wait**.

Adding an online address book

Many email servers, including servers running Microsoft Exchange Server, can verify names with an online address book, also called a directory service or a Global Address List (GAL). After you create and enable an email account, the Messaging application checks your contacts list and then the directory service to verify names that you enter in the To, cc, and bcc fields.

BEFORE YOU BEGIN Do the following:

- Ask your system administrator for the name of the directory service and the server, and whether authentication is required for accessing an online address book.

- If your company is using Exchange Server 2007 or Exchange Server 2003 upgraded to Service Pack 2, you must first synchronize with the Exchange server to enable the GAL to find a contact.

1 Press **Messaging** .

2 Do one of the following:

If the account list is displayed: Press **Menu** (right softkey) and select **Options**.

If the message list for a specific account is displayed: Press **Menu** (right softkey) and select **Tools > Options**.

- 3 Select the **Address** tab.
- 4 Select the address book you want to check for email addresses, and then select **Add**.
- 5 Enter the name of the directory service.
- 6 Enter the server name.
- 7 If your server requires authentication, check the box and enter your username and password.

8 (Optional) Check the **Check name against this server** box to enable this directory service.

9 Select **OK**.

TIP To delete a directory service, highlight it, press and hold **Center** on the 5-way, and then select **Delete**.

Using an online address book

You can access contact information, such as an email address or phone number, from your organization's online address book or GAL. To access a GAL, make sure you are accessing either Exchange Server 2007 or Exchange Server 2003 upgraded to Service Pack 2. This feature is useful only if you know the exact name as it appears in the directory.

DID YOU KNOW? You can use the Global Address List to find a contact. In Contacts, press **Menu** (right softkey) and select **Company Directory**. When sending a meeting request, select **Attendees**, press **Menu** (right softkey), and select **Company Directory**.

BEFORE YOU BEGIN Add access to an online address book to your smartphone (see [Adding an online address book](#)).

- 1 In a new message, select the **To** field.
- 2 Press **Menu** (right softkey) and select **Add Recipient**.
- 3 Press **Menu** (right softkey) and select **Company Directory**.
- 4 Enter the contact name as it appears in the directory and press **Find** (left softkey). You must spell the contact name correctly.

TIP When you sync with Outlook on your computer, disable your online address books to avoid errors. Press **Menu** (right softkey) and select **Tools > Options**. Select **Address**, select each online address book, and uncheck the **Check name against this server** box. Be sure to turn this option back on if you synchronize other email accounts.

Finding messages

You can find messages containing a specific word or phrase. The find feature searches names, email addresses, and subject lines.

- 1 Press **Messaging** .
- 2 Select the account containing the message you want to find.
- 3 Begin typing the word or phrase you want to find. This can appear in any of the address fields or the subject field. The list display changes to show only those messages containing the letters you have entered.
- 4 Continue entering letters to narrow the display until the message you want appears.
- 5 Select the message to open it.

DID YOU KNOW? If you synchronize with Microsoft Outlook 2007, you can also find messages stored on your mail server.

Replying to a message

- 1 Open the message to which you want to reply.
- 2 Press **Reply** (left softkey).
- 3 Enter any text you want to add.
- 4 (Optional) Select **Edit sender's message** to edit the original sender's message text that you include in your reply.

- 5 Press **Send** (left softkey).

DID YOU KNOW? If you reply to a message sent as HTML, the reply is sent in HTML also.

TIP To reply to both the sender and all other addressees, open the message, press **Menu** (right softkey), and select **Reply > Reply All**.

Forwarding a message

- 1 Open the message you want to forward.
- 2 Press **Menu** (right softkey) and select **Reply > Forward**.
- 3 Address the message and enter any text you want to add.
- 4 (Optional) Select **Edit sender's message** to edit the original sender's message text that you include in your reply.
- 5 Press **Send** (left softkey).

Deleting messages

You can delete a message you are reading, or you can delete one or more messages from the message list.

To delete a message you are reading:

- Press **Menu** (right softkey) and select **Delete**.

To delete messages from the message list:

- 1 Highlight the message(s) you want to delete. To highlight multiple consecutive messages, tap and drag the stylus across the messages in the list.
- 2 Press **Delete** (left softkey).
- 3 Select **Yes** to confirm the deletion.

To delete all messages at once:

- 1 Press **Menu** (left softkey) and select **Tools > Clear "[account name]"**.
- 2 Select **Yes** to confirm the deletion.

Messages you delete are moved to the Deleted Items folder. To remove these items from your smartphone completely, press **Menu** (right softkey) and select **Tools > Empty Deleted Items**.

Sorting your messages

You can sort the messages in any folder.

- 1 Go to the Inbox or other folder you want to sort.

- 2 Press **Menu** (right softkey) and select **Tools > Sort By**.
- 3 Select **Message Type, From** (sender), **Received** (date received), or **Subject**.

Using email shortcuts

You can perform common email tasks by pressing and holding certain keys on the keyboard. Highlight or open the message you want, and then press and hold any of the following:

Press and hold...	To...
H	View all email shortcuts
A	Reply to the sender of a message and all other addressees
R	Reply to the sender only
K	Mark a message read or unread
F	Flag a message for follow up
M	Move a message between folders
O	Forward a message
D	Delete a message

Press and hold...	To...
L	Fully download a partially downloaded message
S	Synchronize your smartphone with the server to get and send new messages

Adding a signature to your outgoing messages

You can use a different signature with each email account.

DID YOU KNOW? The default signature text for all accounts is "Sent from my Treo smartphone."

- 1 Press **Messaging** .
- 2 Do one of the following:

If the account list is displayed: Press **Menu** (right softkey) and select **Options**.

If the message list for a specific account is displayed: Press **Menu** (right softkey) and select **Tools > Options**.

- 3 On the Accounts tab, select **Signatures**.
- 4 Select the account for which you want to create a signature.



- 5 Check the **Use signature with this account** box to add this signature to new messages you create with this account.
- 6 (Optional) Check the **Use when replying and forwarding** box to add this signature to messages you reply to or forward with this account.

- 7 Highlight the text in the box at the bottom of the screen, and enter the signature text you want to use.
- 8 Press **OK** (OK).

Customizing your email settings

When you customize settings for an email account, the options you choose apply to that account only.

- 1 Press **Messaging** (Envelope).
- 2 Do one of the following:
 - If the account list is displayed:** Press **Menu** (right softkey) and select **Options**.
 - If the message list for a specific account is displayed:** Press **Menu** (right softkey) and select **Tools > Options**.

- 3 On the Accounts tab, highlight the account you want and set any of the following options:

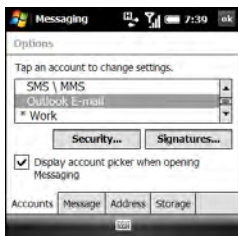

Security: Set whether you receive a warning message before you open a URL or file link that is not on your smartphone.

Display account picker when opening Messaging: Set whether a list of your email accounts appears when you open the Messaging application, allowing you to select the one you want to use. If the box is unchecked, the Messaging application opens to the last account you used.

TIP If the **Display account picker when opening Messaging** box is unchecked, repeatedly press **Right** or **Left** on the 5-way after you open the Messaging application to cycle through your accounts.

- 4 Select the **Message** tab and set any of the following options:

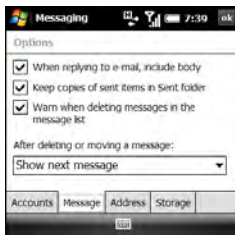

When replying to e-mail, include body: Set whether the body of a message you received appears in your response to that message.

Keep copies of sent items in Sent folder: Set whether messages you send are stored in the Sent folder.

Warn when deleting messages in the message list:

Set whether a confirmation message appears when you delete one or more messages from the message list.

After deleting or moving a message:

Set what you want to see after you delete or move an email message you are reading: the account Inbox or the next message.

- 5 Select the **Address** tab and set any of the following options:

In Contacts, get e-mail addresses from:

Set whether you want to check Contacts in addition to any directory services for email addresses.

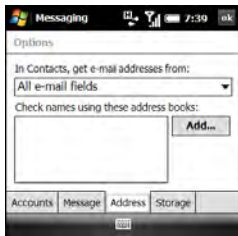
**Check names using these address books:**

Set which directory services you want to check for email addresses.

Add: Enables you to add directory services to the list of online address books.

- 6 Select the **Storage** tab and set any of the following options:

**When available, use this storage card to store attachments:**

Set whether you want to automatically store email attachments on an expansion card (sold separately). You must have a card inserted in your smartphone's expansion card slot to select this option.

Empty deleted items: Select **Immediately** to have the Deleted folder emptied anytime you delete a message. Select **On connect/disconnect** to have the folder deleted anytime you open or quit the Messaging application. Select **Manually** to manually empty the Deleted folder.

TIP If you choose to manually empty the Deleted folder, you delete messages from this folder in the same way that you delete any other messages (see [Deleting messages](#)).

7 Press **OK** .

Changing email download settings: Outlook email accounts

You can customize the download options for an Outlook email account you synchronize with your computer or with an Exchange server.

NOTE To change options for other types of email accounts, see [Changing email download settings: Other email accounts](#).

1 Press **Messaging** .

2 Do one of the following:

If the account list is displayed: Press **Menu** (right softkey) and select **Options**.

If the message list for a specific account is displayed: Press **Menu** (right softkey) and select **Tools > Options**.

3 Select your Outlook email account.

TIP If you select the account name and nothing happens, the Messaging application is currently synchronizing messages for that account. Wait until synchronization stops, and select the name again.

4 Select any of the following options:

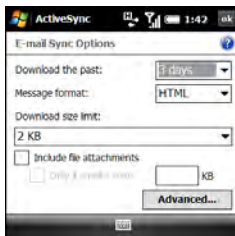

Download the past: Sets the number of days' worth of email to be retrieved for each automatic or manual sync.

Message format: Sets the format for sending and receiving messages. If you select HTML, messages sent to you as HTML are received with their formatting intact. If you select Plain Text, all messages are received as plain text.

Download size limit: Sets the size of an incoming message that is automatically downloaded. For any message that exceeds this size, you must manually download the rest of the message. Selecting a higher limit means that more of your messages are fully downloaded, but message retrieval might take longer. You can also choose to download message headers only, regardless of size.

Include file attachments: Sets whether to download attached files with a message.

Only if smaller than: Sets the maximum size of attachments that can be downloaded. If an attachment

exceeds the maximum size, you must download it manually (see [Opening attachments](#)).

- 5 (Optional) Select **Advanced**, and then select any of the following options:

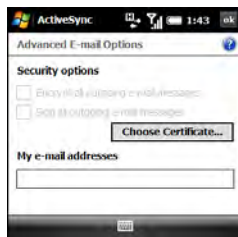

Encrypt all outgoing e-mail messages: Sets whether outgoing messages should be encrypted for extra security. Encryption helps prevent eavesdropping, which occurs when a hacker intercepts and reads your email messages.

Sign all outgoing e-mail messages: Sets whether messages should be given a digital signature as an extra security measure. A signature helps prevent impersonation and tampering.

Choose Certificate: Sets the certificate to use as a digital signature.

My e-mail addresses: Sets the addresses to which the security measures should be applied.

- 6 Press **OK** .

Changing email download settings: Other email accounts

You can customize the download options for each email account that you have with an Internet service provider (ISP) or that you access using a VPN server connection (typically a work account).

NOTE To change options for a Microsoft Office Outlook E-mail account, see [Changing email download settings: Outlook email accounts](#).

- 1 Press **Messaging** .
- 2 Do one of the following:

If the account list is displayed: Press **Menu** (right softkey) and select **Options**.

If the message list for a specific account is displayed: Press **Menu** (right softkey) and select **Tools > Options**.

- 3 Select the email account you want.

TIP If you select the account name and nothing happens, the Messaging application is currently synchronizing messages for that account. Wait until synchronization stops, and select the name again.

- 4 Select **Send/Receive Schedule**.

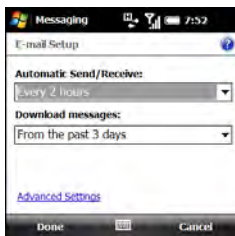

- 5 Select either of the following:

Automatic Send/Receive: Sets the time interval for automatically downloading email, from every

5 minutes to once a day. If you do not want to automatically download messages, select **Manually**.

Download messages: Sets the number of days' worth of email to be retrieved for each automatic or manual retrieval.

TIP To save memory, limit the number of emails that are downloaded to your smartphone by selecting a larger time interval for automatically downloading messages or a smaller time interval for how many days' worth of messages are downloaded.

- 6 Select **Advanced Settings**, and then select any of the following:

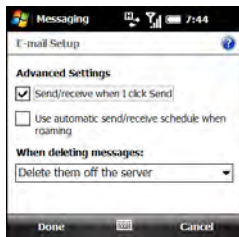

Send/receive when I click Send: Sets whether you can manually send and receive messages, in addition to automatically downloading them.

Use automatic send/receive schedule when roaming: Sets whether automatic downloading takes place when you are roaming. This may result in higher connection charges than downloading while in your home network.

When deleting messages: Sets whether messages should be deleted from the mail server when you delete them on your smartphone, or whether messages you delete on your smartphone should remain on the server.

- 7 Press **Done** (left softkey) twice.
- 8 Select **Download Size Settings**.

9 Select either of the following:

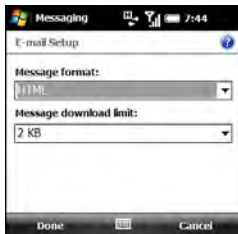

Message format: Sets the format for sending and receiving messages. If you select HTML, messages sent to you as HTML are received with their formatting intact. If you select Plain Text, all messages are received as plain text.

DID YOU KNOW? Messages sent to you as plain text are always received as plain text, even if you select HTML.

Message download limit: Sets the size of an incoming message that is automatically downloaded. For any message that exceeds this size, you must manually download the rest of the message. Selecting a higher limit

means more of your messages will be fully downloaded, but message retrieval might take longer. You can also choose to download message headers only, regardless of size.

10 Press **Done** (left softkey).

Selecting which folders sync: Outlook email accounts

When you synchronize Outlook email either using the sync cable or wirelessly with an Exchange server, messages in the following folders sync by default: Inbox, Outbox, Drafts, Sent, and Deleted Items. You can set other folders to sync, or turn off sync for certain folders.

- 1 Press **Messaging** [✉].
- 2 Select your Outlook email account.
- 3 Press **Menu** (right softkey) and select **Manage Folders**.

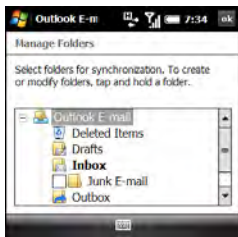

- 4 Check the box next to any folder name to sync that folder. Uncheck the box to remove that folder from sync. If the folder name does not have a box next to it, the folder syncs by default and you cannot turn off sync for that folder.
- 5 (Optional) If a + appears next to a folder name, that folder contains subfolders. Tap the + to display the subfolders, and check or uncheck the box next to any subfolder name to include or remove it from sync.
- 6 Press **OK** .

Working with meeting invitations



You can receive meeting invitations on your smartphone in the same way that you receive email messages.

NOTE Use the Calendar application to create meeting invitations on your smartphone; see [Sending a meeting request](#).

Here are the key features of meeting invitations:

- Meeting invitations appear on your smartphone in the Messaging application, not in the Calendar application.
- From within the Messaging application, you can accept, decline, or tentatively accept a meeting invitation.
- If you accept an invitation, the meeting shows up as an appointment in the Calendar application.

- You can reply to and forward meeting invitations in the same way as email messages.

- 1 Press **Messaging** .
- 2 Select the account you want.
- 3 Select a meeting invitation to open it. Meeting invitations are displayed with this icon: .
- 4 Do one of the following:

To accept the invitation: Press **Accept** (left softkey), select whether to edit (include comments with) your response, and then select **OK**.

To decline or tentatively accept the invitation: Press **Menu** (right softkey) and select **Decline** or **Tentative**.

You can also use menu items to propose a new time, reply to the sender, and flag the invitation for follow-up.

TIP If you receive an updated meeting invitation, you can again choose to accept, decline, or tentatively accept. If you receive a meeting cancellation, you don't need to do anything.

Sending email messages from within another application

You can send files such as pictures, videos, and ringtones as attachments to email messages (see [Creating and sending an email message](#)).

You can send certain files as attachments from within the application where the file is created or stored. For example, if you take a picture with the camera on your smartphone, you can select an option to send the picture as an attachment to an email message. You can also use this feature with videos and sound files. For details, see the chapter on the specific application.



Your text and multimedia messages

If you need to get a short message to a friend or a co-worker fast, send a text message from your Palm® Treo™ Pro smartphone to their mobile phone or email address.

If you need more than text to express yourself, use multimedia messaging to give your message extra impact by adding a photo, video, or sound file.

Benefits

- Enjoy quick communication
- Use text messaging to chat with friends
- Share pictures and videos
- Be as simple or as creative as you want

In this chapter

Sending and receiving text and multimedia messages	139
Setting message preferences	152
Using Windows Live™	155

Sending and receiving text and multimedia messages

You can use the Messaging application to send and receive brief text messages (SMS) and multimedia messages (MMS).

Creating and sending a text message

Each text message can have up to 160 characters. You can send a message of more than 160 characters, but the message may be split into several messages. If you send a text message to an email address, the email address is deducted from the 160-character count.



DID YOU KNOW? You can send and receive text messages even while you are on a phone call. This is easiest when using a hands-free headset or the speakerphone.

BEFORE YOU BEGIN

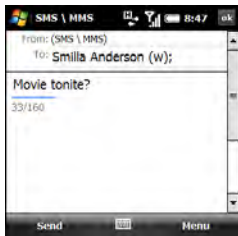
- Before you use your smartphone to send or receive messages, consult your wireless service provider for pricing and availability of text messaging services.
 - Make sure that your phone is on and that you're inside a coverage area (see [Turning your phone on](#)).
- 1 Press **Messaging** .
 - 2 Select **SMS/MMS**.
 - 3 Press **Menu** (right softkey) and select **New > SMS**.
 - 4 Enter the recipient's name, mobile phone number, or email address:



- Enter the first letters of the recipient's first or last name, the first and last initials separated by a space, or the

- email address. If a match is found in your Contacts list, select the name.
- If the recipient's name is in an online address book, you can find the name and add it. See [Using an online address book](#).
 - If the recipient's name and mobile number are not in your Contacts list, enter the full mobile number or email address.
 - Separate addresses with semicolons (;). Enter a semicolon by pressing **Option**  + **K**.
 - Need to enter an underscore? Press **Alt**  and select the character. It's the second character in the list.
- 5 To confirm that addresses you enter are valid, press **Menu** (right softkey) and select **Check Names**. An alert appears if any names or address you've entered are not valid.
 - 6 Enter your message, or press **Menu** (right softkey), select **My Text**, and then select a predefined phrase you want to insert.

TIP To add a new My Text phrase, select **Edit My Text Messages** in the list.

TIP Some symbols can't be used in text messages. Invalid characters are automatically replaced by the Messaging application.

- 7 (Optional) To attach a file to the message, press **Menu** (right softkey), select **Insert**, and then select the file type you want to insert.

DID YOU KNOW? A vCard is a Contact entry. A vCalendar is a Calendar appointment or a task.

DID YOU KNOW? If you attach a file to a text message, you can convert it to a multimedia message. Press **Menu** (right softkey), select **Advanced Composer**, and then see [Creating and sending a multimedia message](#) for instructions.

- 8 (Optional) Press **Menu** (right softkey) and select **Spell Check**.
- 9 (Optional) To receive a notification that the message has been delivered, press **Menu** (right softkey), select **Message Options**, and check the **Request message delivery notification** box.

10 Press **Send** (left softkey).

TIP Press **Menu** (right softkey) and select **Save to Drafts** if you need to finish composing your message later.

Previewing a text message with an attached file

When you attach a file to a text message, you can preview the message and view detailed information about the attached file. If you are sending the message to a contact, you can also view information about the contact.

- 1 Create a text message and attach a file to it (see [Creating and sending a text message](#)).
- 2 Press **Menu** (right softkey) and select **Preview**.
- 3 Do either of the following. Press **OK**  when you have finished.

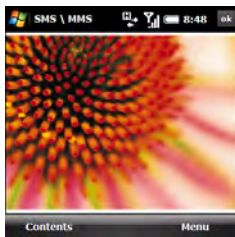

- To view detailed information about the message, press **Menu** (right softkey) and select **Show > Message Detail**.
- To view detailed information about a recipient who is in your Contacts list, press **Menu** (right softkey) and select **Show > Contact Details**.

TIP Press **Menu** (right softkey) when you have a contact's details displayed to see several other options, like permanently blocking future messages from this contact.

- 4 To view detailed information about the attached file, press **Contents** (left softkey), and then press **Properties** (left softkey).

TIP If the file is a picture or video, press **EXIF** (left softkey) to view additional information about the file.

TIP Press **Menu** (right softkey) when you are viewing a message's contents to see several other options, like saving the attached file with a new name.

- 5 Press **OK**  twice to return to the message.

Creating and sending a multimedia message

Multimedia messages consist of pictures, videos, text, and sounds presented as one or more slides. You can include any of the following items:

Ringtones: MIDI

Sound clips: AMR, WAV

Pictures: JPG, GIF, BMP

Videos: 3GPP, 3GPP2, MPEG4

Outgoing multimedia messages can be up to 300KB by default, but your wireless service provider may have a different maximum message size.

IMPORTANT If your smartphone is enrolled with a Yona server, you cannot send and receive multimedia messages from your smartphone.



BEFORE YOU BEGIN

- Before you use your smartphone to send or receive messages, consult your wireless service provider for pricing and availability of multimedia messaging services.
- Make sure that your phone is on and that you're inside a coverage area (see [Turning your phone on](#)).

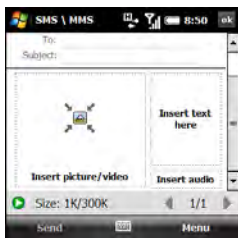
- 1 Press **Messaging** .
- 2 Select **SMSWMS**.
- 3 Press **Menu** (right softkey) and select **New > MMS**.
- 4 Enter the recipient's mobile phone number or email address:



- Enter the first letters of the recipient's first or last name, the first and last initials separated by a space, or the email address. If a match is found in your Contacts list, select the name.
- If the recipient's name is in an online address book, you can find the name and add it (see [Using an online address book](#)).
- If you have recently called or sent a message to the recipient, press **Menu** (right softkey), select **Add Recipient > From Call History**, and then select the recipient.
- If the recipient's name and mobile number are not in your Contacts list, enter the full mobile number or email address.

- Separate addresses with semicolons (;). Enter a semicolon by pressing **Option**  + **K**.
- Need to enter an underscore? Press **Alt**  and select the character. It's the second character in the list.

TIP To display the Cc and Bcc address fields, navigate to the To field and press **Up** on the 5-way.

- 5 Select **Subject** and enter a title for the message.
- 6 Select one or more of the following:

Insert picture/video: Enables you to insert a picture or video. You can take a new picture or video with the built-in camera or insert an existing item.

Insert text here: Enables you to enter a text caption or message for the slide you inserted. You can also tap any of the following icons:



Insert an emoticon.



Insert a web favorite.



Insert a predefined phrase.



Insert a Contacts entry.



Insert a Calendar appointment or task.

Press **Done** (left softkey) when you have finished.

TIP On the text entry screen, select menu items for text size and color, and for the background color.

Insert audio: Enables you to record a message, such as a voice caption for a picture, or insert an existing sound, such as a ringtone. To record a new sound, tap the **record**  icon in the lower-left corner of the screen, select **Record**, and record the sound. Select **Add** when you have finished recording.

TIP To remove an inserted item, press **Menu** (right softkey), select **Remove**, and then select the item you want to remove.

- 7 (Optional) Press **Menu** (right softkey) and select **Slides > Insert Slide** and

repeat step 7 to add another slide in this message.

TIP If you add more than one slide to a message, tap the arrows in the lower right corner of the screen to scroll among the slides. To delete a slide, scroll to the slide you want, press **Menu** (right softkey), and select **Slides > Delete Slide**.

- 8 (Optional) To add a vCard (Contacts entry), vCalendar (Calendar appointment or task), or other file type to a message, press **Menu** (right softkey) and select **Attachment**. Press **Menu** (right softkey) again and select the type of file you want to add.

TIP To remove an attachment, press **Menu** (right softkey) and select **Attachment**. Highlight an attachment, press **Menu** (right softkey), and select **Delete**. To remove all attachments, press **Menu** (right softkey) and select **Delete All**.

- 9 To change the background color for the message, press **Menu** (right softkey), select **Options**, select **Background**, and then select the color you want.

10 To change the positioning of text and graphics in the message, press **Menu** (right softkey), select **Options**, and then select **Text Layout**. Select the positioning that you want, and press **Done** (left softkey).

11 Press **Send** (left softkey).

DID YOU KNOW? You can send a special type of multimedia message, called a VoiceMail, that contains just an audio clip you record. Press **Menu** (right softkey) and select **New > VoiceMail**. Record the clip, address the message, and press **Send** (left softkey).

TIP You can send your message as a text message. This may save on data charges, but you may lose some formatting, and the message text may be truncated. Press **Menu** (right softkey) and select **Send via SMS**.

TIP To save your message as a template for future messages, press **Menu** (right softkey) and select **Template > Save as Template**.

Organizing slides within a multimedia message

If your message contains more than one slide, you can change the order of the slides and change the duration for each slide during playback.

1 On the message compose screen, press **Menu** (right softkey) and select **Slides > Organize Slides**.



2 Do any of the following:

Move a slide: Highlight the slide, press **Menu** (right softkey), and select **Move Forward** or **Move Backward**.

Change display time for slides: Tap a black arrow beneath a slide to increase or decrease the duration. The minimum duration is two seconds.

Insert slides: Press **Insert** (left softkey).

Remove slides: Press **Menu** (right softkey) and select **Delete**.

3 Press **OK** .

Setting options for an outgoing multimedia message

You can set send options for a single multimedia message. You can also set options for all multimedia messages you send and receive (see [Customizing additional multimedia message settings](#)).

- 1 Press **Messaging** .
- 2 Select **SMS/MMS**.
- 3 Press **Menu** (right softkey) and select **New > MMS**.
- 4 Select **Custom** to create your own message, or select a template.
- 5 Press **Menu** (right softkey) and select **Options > Send Options**.



- 6 Select any of the following:

Delivery: Sets whether to send the message now or after a certain time interval. For example, if you are currently roaming, you might want to wait to send messages until you are in your home network to save data charges.

Expiration: Sets how long messages remain available to be sent if the recipient's phone or email address is not available when you originally send the message. For example, if your messages generally contain information that will not be useful to recipients after an hour, you can set the validity for one hour. Select **Maximum** to allow messages to remain available for the maximum period of time permitted by your wireless service provider.

Priority: Sets High, Medium, or Low priority.

Category: Sets the message type. Some recipients may block certain types of messages or allow only certain types of messages.

Delivery/Read report: Sets whether you want to receive confirmation that the message has been delivered or has been read.

TIP To set the options you select as the default for all outgoing multimedia messages, press

Menu (right softkey) and select **Set as default**. To restore the original default settings, press **Menu** (right softkey) and select **Restore factory default**.

7 Press **Done** (left softkey).

Receiving text messages

When your phone is on and you are in a wireless coverage area, you automatically receive new text messages.

When a new message notification appears, select one of the following options:



Reply (left softkey): Opens the message in chat view so you can view its full contents and reply to the sender (see [Using Messaging to chat](#)).

Menu (right softkey) > Delete: Deletes the new message.

Menu (right softkey) > Call sender: Dials the sender's phone number.

Menu (right softkey) > Save as read: Puts the message in your SMS\MMS Inbox as read.

Menu (right softkey) > Dismiss: Dismisses the notification and puts the message in your SMS\MMS Inbox as unread.

If you have multiple messages, the notification includes the number of messages.

Receiving multimedia messages

You can set your smartphone to automatically download new multimedia messages or to notify you that messages are ready to download.

When a new message notification appears, select one of the following options:



Hide (left softkey): Dismisses the notification. **Menu (right softkey) > View:** Opens the message in chat view so you can view its full contents and reply to the sender (see [Using Messaging to chat](#)).

Menu (right softkey) > Dismiss: Dismisses the notification and puts the message in your SMS/MMS Inbox as unread.

If you have multiple messages, the notification includes the number of messages.

Viewing a text message

To open a text message, do one of the following:

- Press **Messaging**  and select **SMS/MMS**. From the Inbox, select the message you want to view.
- From a notification, select **Reply**. The message opens in chat view so you can view its full contents and reply to the sender (see [Using Messaging to chat](#)).

Viewing a multimedia message

- 1 To open a multimedia message, do one of the following:
 - Press **Messaging**  and select **SMS/MMS**. From the Inbox, select the message you want to view.
 - From a notification, press **Menu** (right softkey) and select **View**. The message opens in chat view displaying the sender and subject (see [Using Messaging to chat](#)).
- 2 Select the message in chat view to view the full message with any inserted images or files.

- 3 With the message open, do any of the following:

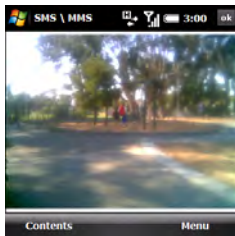

Forward the message: Press **Menu** (right softkey) and select **Forward**.

Reply to the message: Press **Menu** (right softkey), select **Reply**, and then select a reply method: **MMS**, **SMS**, or **VoiceMail**.

View detailed information about the message: Press **Menu** (right softkey) and select **Show > Message Detail**.

View detailed information about a recipient who is in your Contacts list: Press **Menu** (right softkey) and select **Show > Contact Details**.

TIP Press **Menu** (right softkey) when you have a contact's details displayed to see several other options, like permanently blocking future messages from this contact.

View detailed information about the attached file: Press **Contents** (left softkey), and then press **Properties** (left softkey).

TIP Press **Menu** (right softkey) when you are viewing a message's contents to see several other options, like saving the attached file with a new name.

DID YOU KNOW? When viewing a multimedia message containing multiple slides, you can press **Right** on the 5-way to move to the next slide, or press **Left** on the 5-way to move to the previous slide.

- 4 Press **OK** .

Using Messaging to chat



When you exchange more than one message with a single contact, the messages you exchange with that person are grouped into a chat session. When you select a chat session from your message

list, the upper part of the screen displays all messages you've exchanged with this contact, and the lower part provides a text entry area.

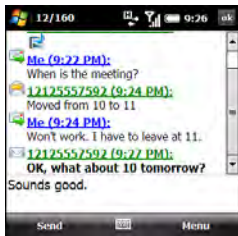
- 1 Press **Messaging** .
- 2 Select **SMSWMS**.
- 3 To start a new chat or continue an existing chat, select the message to which you want to reply. The message opens in chat view.



- 4 Enter your message. You can use any of the menu commands described in [Creating and sending a text message](#).
- 5 Press **Send** (left softkey).

- 6 If an incoming message has a file attached, it appears in the chat list with this icon: . Select the message to open it and view the attachment.
- 7 To close the chat session and return to the account Inbox, press **OK** .

NOTE In the Inbox, all messages from a chat session are displayed as one item: a single conversation. To view individual messages within the conversation, select it to reopen the chat session.

DID YOU KNOW? While chat view remains open, any new messages you receive from your chat partner appear directly on the screen, and you do not get a new message notification.

Using links in messages

When you receive a text message that contains a telephone number, email address, or URL, you can dial the number, send an email message, or go to the web page immediately. Your smartphone automatically opens the appropriate application from the link.

- 1 Open a message in the Inbox or another folder.
- 2 Use the 5-way to select the phone number, email address, or URL (appears as underlined blue text).
- 3 For phone numbers, confirm or change the number and press **Call** (left softkey).

If you receive a multimedia message that contains a phone number, email address, or URL, tap the item to open a menu of actions you can perform.

Adding a contact from a message

You can add a contact name, phone number, or email address to your Contacts list directly from a received message. You can either create a new contact or add the information to an existing contact.

- 1 In an open message or chat session, select the name, phone number, or address of the contact you want to add.
- 2 Select **Yes**.
- 3 Select **<New Contact>** to create a new contact entry for this name or address, or select an existing contact to add the name or address to that entry.

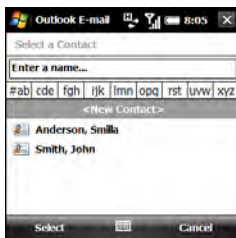

- 4 Enter or edit the contact information.
- 5 Press **Save** (left softkey).

DO YOU KNOW? When you enter or edit a contact phone number from a message, you can insert one or more pauses by pressing **Menu** (right softkey) and selecting **Insert Pause**. You can also insert an indefinite pause that allows you to respond to dialing instructions by pressing **Menu** (right softkey) and selecting **Insert Wait**.

Sorting your messages

You can sort the messages in any folder.

- 1 Go to the Inbox or other folder you want to sort.

- 2 Press **Menu** (right softkey) and select **Tools > Sort By**.
- 3 Select **Message Type, From** (sender), **Received** (date received), or **Subject**.

Deleting messages

- 1 Go to the Inbox or other folder containing the message you want to delete.
- 2 Do one of the following:
 - To delete one message, highlight it.

NOTE If you highlight a conversation containing multiple messages, all of the chat messages are marked for deletion.

- To delete multiple consecutive messages, tap and drag with the stylus to highlight all the messages you want to delete.
 - To delete all messages at once, press **Menu** (right softkey) and select **Tools > Clear “SMS/MMS”** and skip to step 4.
- 3 Press **Delete** (left softkey).
 - 4 Select **Yes** to confirm the deletion.

Messages you delete are moved to the Deleted Items folder. To remove these items from your smartphone completely, press **Menu** (right softkey) and select **Tools > Empty Deleted Items**.

Setting message preferences

You can set options for both text and multimedia messages in the Messaging application. You can set options for all messages and for multimedia messages only.

You can also set send options for a single text message (see [Creating and sending a text message](#)) and for a single multimedia message (see [Setting options for an outgoing multimedia message](#)).

Customizing settings for text and multimedia messages

- 1 Press **Messaging** .

2 Do one of the following:

If the account list is displayed: Press **Menu** (right softkey) and select **Options**.

If the message list for a specific account is displayed: Press **Menu** (right softkey) and select **Tools > Options**.

3 Select **SMS/MMS**.

4 Select either or both of the following:

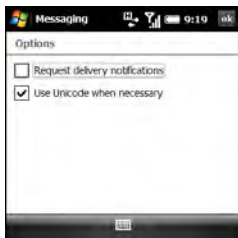

Request delivery notifications:

Indicates whether you want to receive a confirmation when a message is delivered.

Use Unicode when necessary:

Automatically converts a message to Unicode language if the receiving device requires it.

5 Press **OK** [OK].

Customizing additional multimedia message settings

BEFORE YOU BEGIN If you want to enter new server information or change existing server information in step 6 below, obtain the following from your wireless service provider or your multimedia message service center:

- Server name
- Gateway
- Port number
- Server address
- Connection method
- Maximum size of outgoing messages
- WAP version

1 Press **Messaging** [M].

2 Select **SMS/MMS**.

3 Press **Menu** (right softkey) and select **MMS Options**.

- 4 On the Preferences tab, select any of the following:

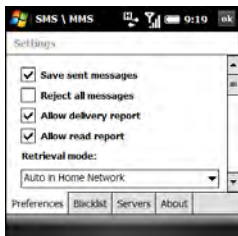

Save sent messages: Specifies that sent multimedia messages are to be saved in the Saved folder on your smartphone.

TIP To free up storage space on your smartphone, uncheck this option.

Reject all messages: Indicates that all incoming messages are to be rejected.

Allow delivery report: Sets whether you want to receive confirmation that the message has been delivered.

Allow read report: Sets whether you want to receive confirmation that the message has been read.

Retrieval mode: Sets whether multimedia messages are downloaded automatically both when you are in your home network and are roaming, messages are downloaded when you are in your home network only, or you receive a prompt to download multimedia messages manually.

- 5 Select the **Blacklist** tab to view names and phone numbers that you have blacklisted. To remove an entry from the blacklist, tap and hold on the entry with the stylus and select **Delete**.
- 6 Select the **Servers** tab and do one of the following. Press **Done** (left softkey) when you have finished.

View or edit existing server information: Select the server name.

Enter new server information: Select **New**. To enter or edit server information, use the information you obtained from your wireless service provider or multimedia message service center.

TIP To see all of the server options, tap and drag the scroll bar with the stylus.

Set a server as the default for sending multimedia messages

Highlight the server name and select **Set As Default**.

7 Press **OK** .

Using Windows Live™

NOTE Windows Live™ is not supported by all wireless service providers.

Windows Live is a set of services that combines online search features, email, and instant messaging:



Live Search: Enables you to search for text on the web directly from your smartphone.

Windows Live Mail: The next generation of the Hotmail web-based email application. Windows Live Mail offers more

storage, greater message security, and easier filing of messages.



Windows Live Messenger: Enables you to see who's online and exchange instant messages (IM). Make calls to phones and computers (including video calls) and exchange pictures and other files.

Using Live Search

- 1 Press **Start**  and select **Programs**.
- 2 Select **Windows Live** .
- 3 In the search bar at the top of the screen, enter the text you want to find.
- 4 Press **Center** .
- 5 Select the item you want from the search results. If the item you want does not appear, select **More** to see more results.

Setting up Windows Live Mail

BEFORE YOU BEGIN You must have an existing Windows Live, MSN, or Hotmail account to use Windows Live Mail. If you do not have an account, use the web browser on your smartphone to go to hotmail.com, and follow the steps you find there to set up an account.

- 1 Press **Start**  and select **Programs**.
- 2 Select **Windows Live** .
- 3 Select **Sign in to Windows Live**.

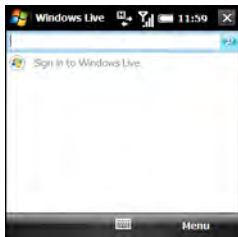

- 4 The first time you sign into Windows Live, press **Accept** (left softkey).
- 5 Enter your Windows Live, MSN, or Hotmail email address and password. Leave the Save password box checked if you want to have your password entered automatically.



- 6 Press **Next** (left softkey).
- 7 Check the **Live Search bar** box to have the Live Search bar appear on your Today screen. Check the **Windows Live services** box to have Windows Live Email and Windows Live Messenger appear on your Today screen.

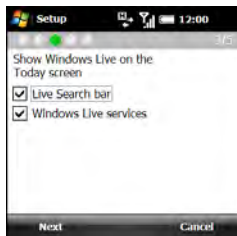

- 8 Press **Next** (left softkey).
- 9 Select any of the following:

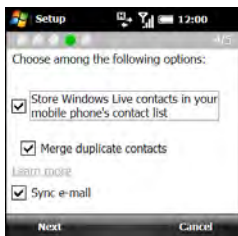

Store Windows Live contacts in your mobile phone's contact list:

Sets whether you want your Windows Live contacts to appear in Contacts. If you do not check this box, only your Windows Live email messages are synchronized with your smartphone.





Merge duplicate contacts: Sets whether you want to merge any synchronized Windows Live contact with any duplicate contact that's already in Contacts, so that there is only one entry for this contact. If you leave the box unchecked, two entries appear for any duplicate entry in Contacts.





Sync e-mail: Sets whether you want to download your Windows Live Mail messages to your smartphone (see [Using Windows Live Mail](#)).

- 10 Press **Next** (left softkey). Synchronization of Windows Live email and contacts (if selected) takes place.
- 11 After synchronization has finished, press **Done** (left softkey). Your most recently received email message is displayed.

Using Windows Live Mail

BEFORE YOU BEGIN Make sure that your phone is on and that you're inside a coverage area (see [Turning your phone on](#)).

- 1 Press **Start**  and select **Programs**.
- 2 Select **Windows Live** .
- 3 To synchronize email, contact, and/or Windows Live Messenger information, do the following:
 - Press **Down**  to move the highlight to the field directly beneath the Live Search bar.
 - Press **Right**  or **Left**  until **Sync** appears.



- Press **Center** . Information is synchronized for any of the applications you selected during setup.
- 4 To read your email, do the following:
- With the same field highlighted, press **Right**  or **Left**  until **Windows Live Hotmail** appears.
 - Press **Center** . The Messaging application opens, displaying your Windows Live Hotmail Inbox. You can view, send, and work with messages in your Windows Live Hotmail account in the same way as with messages for any other account.

DID YOU KNOW? You can also access your Windows Live Hotmail Inbox by opening the Messaging application and selecting your Windows Live Hotmail email account.

TIP You can set an option to have messages pushed to Windows Live Mail on your smartphone as they arrive on the server. Open Windows Live, press **Menu** (right softkey), and select **Options**. Select **Sync schedule**, select the **Sync frequency** list, and then select **As items arrive**.

Using Windows Live Messenger

BEFORE YOU BEGIN

- You must have an existing Windows Live, MSN, or Hotmail account to use Windows Live Messenger. If you do not have an account, use the web browser on your smartphone to go to hotmail.com, and follow the steps to set up an account.
 - Make sure that your phone is on and that you're inside a coverage area (see [Turning your phone on](#)).
- 1 Press **Start**  and select **Programs**.
 - 2 Select **Messenger** .
 - 3 Press **Sign in** (left softkey).
 - 4 If you have not already set up a Windows Live Mail account on your smartphone (see [Setting up Windows Live Mail](#)), the first time you sign into Windows Live Messenger, press **Accept** (left softkey).
 - 5 If prompted, enter your Windows Live, MSN, or Hotmail email address and password.
 - 6 To send an instant message to a contact who is online, highlight the contact name and press **Send IM** (left softkey).

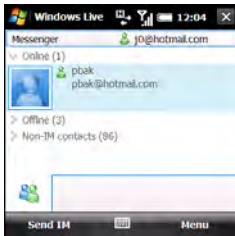

TIP If the contact you want is offline, send an email message instead. Highlight the contact name and press **Send e-mail** (left softkey). Enter a subject and body text for the email message and press **Send** (left softkey).

7 Do one of the following:

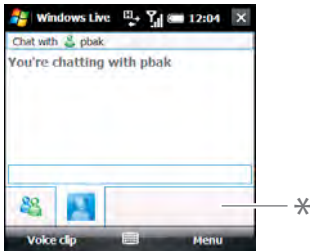

* Text entry bar

- Highlight the text entry bar and enter your message text.
 - Press **Voice clip** (left softkey) and record a voice note by speaking clearly with your smartphone held up facing you.
- 8 (Optional) To add an emoticon to your message, press **Menu** (right softkey), select **Add emoticon**, and then select the emoticon you want.
 - 9 (Optional) To send a picture or other file, press **Menu** (right softkey), select **Send**, and then select the type of file you want to send. Capture or select the picture or other file you want.
 - 10 (Optional) To exchange messages with more than one person, press **Menu** (right softkey) and select **Options > Add participant**. Select the participant you want to add.
 - 11 To end the messaging session, press **Menu** (right softkey) and select **End conversation**. If you are exchanging messages with more than one person, select **End all conversations** to stop all the sessions at once.

TIP From the Messenger contacts list screen, press **Menu** (right softkey) and select options to add, block, or remove a contact; change your status to Busy, Away, and so on; add a display picture or personal message; and more.



Your connections to the web and wireless devices

You use the web for so many things: finding driving directions, getting news, buying gifts, checking web-based email. With your wireless service provider's network and your smartphone's web browser, you can take the web with you almost anywhere you go.

The Bluetooth® wireless technology on your Palm® Treo™ Pro® smartphone helps you easily set up wireless connections to a number of devices. You can also use your smartphone to connect your computer to the Internet and to share contacts or your favorite photos. Or use the Wi-Fi feature to connect to a public, work, or home network.

Benefits

- Carry the web with you
- Enjoy cable-free connectivity:
Connect to Bluetooth headsets and car kits
- Connect your computer to the Internet through your smartphone
- Choose the method of connecting to the Internet that's most convenient for you

In this chapter

Browsing the web	163
Working with streaming content	170
Getting online travel information and tools.	172
Determining your GPS location	173
Connecting to a Wi-Fi network	174
Connecting to devices with Bluetooth® wireless technology	183
Using your device as a wireless modem	187

Browsing the web

Internet Explorer Mobile provides quick and easy access to web pages. You can view most sites on your smartphone that you can view on your computer, including those with security and advanced features, such as JavaScript and frames.

Internet Explorer Mobile supports JavaScript, Secure Sockets Layer (SSL), and cookies, but does not support plug-ins (Flash, Shockwave, VBScript, WML script, and so on) or Java applets.

TIP For additional information on features supported by Internet Explorer Mobile, visit microsoft.com.

DID YOU KNOW? The Security certificates and 128-bit SSL strong encryption enable you to browse secure sites, such as online shopping, banking, and email. Remember, some secure sites also require a specific browser and may not work with Internet Explorer Mobile. Ask the organization for an alternate web address (URL) that is compatible with Internet Explorer Mobile.

BEFORE YOU BEGIN Do the following:

- Be sure to subscribe to data services from your wireless service provider. This is necessary for browsing the web.
- Make sure your phone is on and that you're inside a coverage area (see [Turning your phone on](#)).

Viewing a web page

By default, Internet Explorer Mobile scales web page content to fit your smartphone screen so that you can view most of the information without scrolling left or right.

DID YOU KNOW? You can also start a web search from your Today screen by selecting the Web search field, entering the item you want to find, and pressing **Center** on the 5-way.

- 1 Press **Start**  and select **Internet Explorer**.

TIP If your Today screen is displayed, press **Internet** (right softkey) to open Internet Explorer Mobile.

- Highlight the address line, enter the address of the web page you want to view, and press **Center** . To return to a recently viewed page, select the address line list, and then select the web address.

DID YOU KNOW? If you browse to a secure web page, the lock icon in the address line appears closed instead of open.

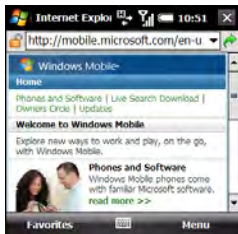

- Press **Menu** (right softkey), select **View**, and then select one of the following:
 - One Column:** Arranges web pages into one column that is as wide as the screen, so that you don't have to scroll horizontally.

Fit To Screen: Maintains a layout similar to what you see on a desktop computer, but it makes items smaller and arranges the content so that you can see most of it without scrolling horizontally.

Desktop: Keeps the same layout and size as on a desktop computer, which requires both horizontal and vertical scrolling.

Full Screen: Hides the status and navigation areas and fills the entire screen with the web page. To exit full screen mode, press the right softkey, or tap and hold anywhere on the screen and uncheck **Full Screen**.

Show Pictures: Shows or hides pictures on web pages. Hiding pictures speeds up the time it takes to load pages.

- Press **OK**  to close Internet Explorer Mobile.

Navigating web pages

Here are some tips on viewing web pages and moving around in them:

View the previous page: Press **Back** (left softkey) or **Backspace** (↩).

Move forward through viewed pages after having moved back to a previous page: Press **Menu** (right softkey) and select **Forward**.

Go to your home page: Press **Menu** (right softkey) and select **Home**.

Refresh a page: Press **Menu** (right softkey) and select **Refresh**.

Scroll through the page in One Column View or Default View: Press **Up** ▲ or **Down** ▼. In Desktop View, press **Up** ▲, **Down** ▼, **Left** ◀, or **Right** ▶ to scroll in all directions.

Follow a link: Press **Up** ▲ or **Down** ▼ to highlight the link, and then press **Center** ○ to go to the selected page. You can also tap the link on the screen with the stylus.

Send email from a web page: Select the address link. You need to configure an

email application on your smartphone before you can use this feature (see [Your email](#)).

Shrink the web page to fit on the screen: Press **Menu** (right softkey), select **View** > **Zoom Out**. To return to normal view, press **Zoom In** (left softkey).

Adjust text size: Press **Menu** (right softkey), select **View** > **Zoom Level**, and then select the size you want.

View page properties: Press **Menu** (right softkey) and select **Tools** > **Properties**.

View items in a list: Select the list and scroll using **Up** ▲ or **Down** ▼.

Cycle between list items: Press **Left** ◀ or **Right** ▶, and then press **Center** ○ to select a list item.

Interact with a form: Press **Center** ○ to interact with the form, and then press **Center** ○ again to stop interacting with the form.

Send a link: Press **Menu** (right softkey) and select **Tools** > **Send Link**. Select the option you want to use to send the link: **SMS/MMS** (text message), **MMS**

(multimedia message), or an email account.

Creating a favorite

Favorites let you bookmark a web page so that you can instantly access it without entering the web address.

BEFORE YOU BEGIN First, create the folders where you want to store your favorites first. After you create a favorite, you can't move it to another folder (see [Organizing your favorites](#)).

- 1 Go to the page you want to mark as a favorite.
- 2 Press **Menu** (right softkey) and select **Add to Favorites**.



- 3 (Optional) Select **Name** and enter a different description.
- 4 (Optional) Select **Create in**, and then select the folder where you want to create the favorite.
- 5 Select **Add**.

TIP To delete a favorite or folder, press **Menu** (right softkey) and select **Favorites**. Select the **Add/Delete** tab, highlight the item you want to delete, and select **Delete**. Select **Yes** to confirm deletion and press **OK**.

Viewing a favorite



- 1 Press **Start** [F5] and select **Internet Explorer**.
- 2 Press **Menu** (right softkey) and select **Favorites**.

TIP When you first open Internet Explorer, press **Favorites** (left softkey) to view your favorites.

- 3 Select the page you want to view in the list.

Organizing your favorites

You can create folders to organize your favorites. For example, you can store travel links in one folder, stock links in another, and business links in a third folder.

- 1 Press **Start**  and select **Internet Explorer**.
- 2 Press **Menu** (right softkey) and select **Favorites**.
- 3 Select the **Add/Delete** tab.
- 4 Select **New Folder**.
- 5 Enter a name for this folder and select **Add**.
- 6 Press **OK** .

Downloading files and images from a web page

You can download files that are usable on your smartphone, such as new applications, MIDI ringtones, or pictures.

- 1 Go to the page that contains the link to the file you want to download.
- 2 Do one of the following:
To download a picture: Tap and hold on the image with the stylus, and select **Save Image**.

To download any other type of file:

Select the link to the file

- 3 (Optional) To have the file open automatically after being downloaded, check the **Open file after download** box.
- 4 Do one of the following:

To save the file with its current name to the default location (My Documents or My Pictures): Select **Yes**.

To save the file with a different name or to a different location: Select **Save As** and enter any of the following:

- Select **Name** and enter a new name for the file.
- Select the **Folder** list, and then select the folder where you want to save the file.
- Select the **Location** list, and then select where you want to store the file: **Main memory** or **Storage card**. The Storage card option appears only if you have an expansion card (sold separately) inserted into your smartphone.
- Select **Save**.

Copying text from a web page

You can copy text from a web page and paste it in other applications.

- 1 Use the stylus to highlight the text you want to copy.
- 2 Press **Menu** (right softkey) and select **Edit > Copy**.
- 3 Go to the application in which you want to paste and position the cursor where you want to paste the text.
- 4 Press **Menu** (right softkey) and select **Edit > Paste**.

TIP If Internet Explorer Mobile does not recognize a phone number as dialable, you can paste the phone number (as text) and paste it into the phone Keypad.

TIP You can copy the text from the entire web page. With the cursor anywhere on the page, press and hold **Center** on the 5-way and select **Select All Text**. Press and hold **Center** again and select **Copy**.

Returning to recently viewed pages

The History list stores the addresses of the pages you visited recently.

- 1 Press **Menu** (right softkey) and select **Tools > History**.
- 2 (Optional) Tap the **Show** list in the upper-left and select how you want to sort the History list.
- 3 Select the web page you want to view.

Customizing your Internet Explorer Mobile settings

- 1 Press **Menu** (right softkey) and select **Tools > Options**.
- 2 On the General tab, set any of the following options:

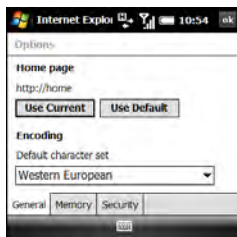

Home page: Sets the page that appears when you open Internet Explorer Mobile. To set the home page, first navigate to that page in Internet

Explorer Mobile, access this settings screen again, and select **Use Current**. To select the original home page, select **Use Default**.

Default character set: Sets the character set for the web pages you view.

- 3 Select the **Memory** tab and set any of the following options:



Save links to pages visited in the past: Sets how many days of activity the History list stores.

Clear History: Empties the History list.

Delete Files: Removes web files that you previously viewed or synchronized with your computer.

- 4 Select the **Security** tab and set any of the following options:

Allow cookies: Sets whether your smartphone accepts cookies (small files containing info about your identity and preferences). The page sends the file and stores it on your smartphone.



Clear Cookies: Deletes any cookies stored on your smartphone.

Warn when changing to a page that is not secure: Sets whether a message appears when you switch from a secure page to one that is not secure.

Warn when page content is blocked due to security settings: Sets whether a message appears when you attempt to open a page that does not meet the

security standards associated with your smartphone.

- 5 Press **OK** .

Working with streaming content



When you select a link to view streaming content in your smartphone's web browser, the Streaming Media app works in the background to display the content. You can also access streaming media by entering a web address in the Streaming Media app itself.

Connecting to streaming content

BEFORE YOU BEGIN Do the following:

- Be sure to subscribe to data services from your wireless service provider.
- Make sure your phone is on and that you're inside a coverage area (see [Turning your phone on](#)).
- Make sure you know the web address (URL) of the Real Time Streaming

Protocol (RTSP) website containing the content you want to view.

- 1 Press **Start**  and select **Programs**.
- 2 Select **Streaming Media** .
- 3 Press **Connect** (left softkey).
- 4 Enter the address of the RTSP website containing the media you want to view.
- 5 Press **Connect** (left softkey).

Viewing streaming content

Do any of the following while viewing the content:

Begin playback: Tap .

Pause playback: Tap .

Rewind: Tap .

Fast forward: Tap .



Zoom in or out: Press **Up**  or **Down**  on the 5-way.

Mute the sound: Press **Menu** (right softkey) and select **Mute**.

View the content on the full screen: Press **Menu** (right softkey) and select **Full screen**.

View content properties: Press **Menu** (right softkey) and select **Properties**.

Customizing Streaming Media

- 1 Press **Start**  and select **Programs**.
- 2 Select **Streaming Media** .
- 3 Press **Menu** (right softkey) and select **Options**.
- 4 On the Playback tab, select any of the following options:



Media Buffer: Content is streamed in chunks of several seconds each. The interval you select specifies how many seconds' worth of content are sent in each chunk. Selecting a higher number means that you can view a longer

amount of content in each chunk, but you may have to wait longer for each chunk to be streamed.

Do not show 'Connect to Internet' message: Specifies whether you want to be alerted if you attempt to connect to a streaming media site when your smartphone is not connected to the Internet. If this box is checked, your smartphone automatically connects to the Internet if it is not already connected.

- 5 Select the **Networks** tab, and then select any of the following options:

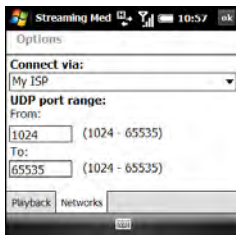

Connect via: Specifies the method you want to use to connect to the streaming website: your wireless service provider

connection (ISP), your work network, or another type of network connection.



UDP port range: Specifies the lowest and highest port numbers for the network to use when searching for UDP ports for streaming media.

- 6 Press **OK** .



Getting online travel information and tools

With WorldMate, you can gain access to your travel itinerary details, global weather forecasts, world clocks, currency, clothing size and measurement converters, a tip and tax calculator, and more.

Downloading the WorldMate application

- 1 Press **Start**  and select **Programs**.
- 2 Select **Get WorldMate** .
- 3 Follow the onscreen instructions to download and install the software.

Using WorldMate

- 1 Press **Start**  and select **Programs**.
- 2 Select **WorldMate** .
- 3 Press **Next** (left softkey).
- 4 The first time you open the app, press **Accept** (left softkey).
- 5 Enter your email address, and then enter it again to confirm.

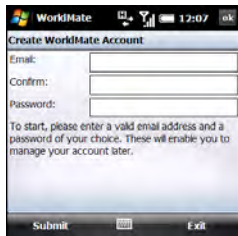

- 6 Make up and enter a password of your choice. This does not need to be your email account password.
- 7 Press **Submit** (left softkey).
- 8 Select the city nearest to your home city.
- 9 Press **Next** (left softkey).

- 10 Select an option to access a WorldMate feature: **Weather Center**, **Flight Center**, **My Itinerary**, **Travel Tools**, or **Converters**.





NOTE For each feature, some options are available to WorldMate Professional subscribers only. WorldMate Professional is a paid service. To subscribe, select **Go Pro**.

TIP From any screen, press **Menu** (right softkey) and select **Options** to set the interval for automatically updating weather and other information, set the temperature display format, and set whether to automatically preview your itinerary.

Determining your GPS location

QuickGPS can speed up the process of determining your GPS position by downloading the latest satellite information over your smartphone's Internet connection.

- 1 Press **Start**  and select **Programs**.
- 2 Select **QuickGPS** .
- 3 Press **Center**  to download satellite information.

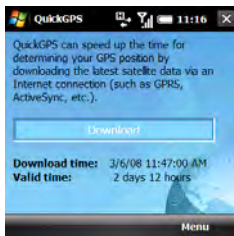

To customize QuickGPS, press **Menu** (right softkey) and select **Options**. You can choose whether to be notified when your GPS satellite information expires, whether

to automatically download new satellite information, and whether to perform an automatic download when your smartphone is connected to your computer using the USB cable.

Connecting to a Wi-Fi network

Many environments, such as corporate offices, coffee shops, airports, and libraries, offer access to a Wi-Fi network. A Wi-Fi network is a wireless local area network (WLAN) based on the 802.11 standard. When you're within range of an accessible Wi-Fi network, you can use your smartphone's Wi-Fi feature to connect to that network and access the web.

KEY TERM Wi-Fi access point Also called a hotspot. A network device with an antenna that provides wireless connections to a larger network.

Why use a Wi-Fi connection?

A Wi-Fi connection is especially helpful in the following situations:

- You're outside a coverage area and you want to access the web.
- Your wireless service provider's plan incurs additional charges for data services and you want to minimize data service charges by using a Wi-Fi connection instead.
- You're inside a coverage area, but outside your wireless service provider's UMTS (3G or HSDPA) coverage area. (A Wi-Fi connection may provide faster throughput than a GPRS or EDGE data connection.)
- You want to maintain a web connection while talking on the phone.

Are there different types of Wi-Fi networks?

There are two types of Wi-Fi networks:

Open networks: These networks broadcast their name (SSID) and do not require you to enter a password or other settings. To learn how to connect to an



open network, see [Connecting to an open network](#).

Secure networks: These networks may broadcast their name, but at the very least, they require you to enter a password that you get from an administrator (who may be, for example, the librarian or the person behind the counter at the coffee shop). You may also have to get other network settings from the system administrator. To learn how to connect to a secure network, see [Connecting to a secure network](#).

If you've already set up a connection to a secure network and want to reconnect to it, follow the steps in [Connecting to an open network](#).

Turning the Wi-Fi feature on and off

BEFORE YOU BEGIN Make sure your smartphone screen is on (see [Waking up the screen and turning it off](#)).

- To turn Wi-Fi on, press **Wi-Fi**  (on the side of your smartphone near the stylus slot).
- To turn Wi-Fi off, press and hold **Wi-Fi** .

When Wi-Fi is on, your Today screen displays Wi-Fi: On.

TIP By default, when your screen turns off, the Wi-Fi feature turns off to save power. Wi-Fi does not turn back on automatically when your screen turns back on. You can adjust the Wi-Fi settings to keep Wi-Fi on all the time. See [Customizing Wi-Fi settings](#) for details.

Connecting to an open network

You can connect to an open network or to a secure network for which you already set up a connection. If you have access to multiple Wi-Fi networks, you can select the network to which you want to connect.

NOTE The WEP (wired equivalent privacy) encryption method is enabled by default and may interfere with your ability to connect to a network that broadcasts its name. See [Connecting to a secure network](#) to learn how to disable WEP encryption.

- 1 Press **Wi-Fi**  (on the side of your smartphone near the stylus slot). What happens next depends on the state of Wi-Fi before you pressed the button:

Wi-Fi was already on: Your smartphone scans for available networks and automatically connects when possible. If your smartphone does not automatically connect and the Configure Wireless Networks screen appears, highlight the network you want, and press **Connect** (left softkey).

Wi-Fi was off: A notification appears listing three available networks. If the network you want appears, highlight it and press **OK** (left softkey) to connect. If the network you want does not appear, select **Show all networks**, highlight the network you want, and press **Connect** (left softkey).

TIP To dismiss the notification without connecting to a network, press **Menu** (right softkey) and select **Dismiss**. To turn off the notification feature, press **Menu** (right softkey) and select **Don't show this message again**. You can turn the feature back on later (see [Customizing advanced Wi-Fi settings](#)).

- 2 When the connection message appears, press **Dismiss** (right softkey).

TIP Narrow the list of networks that appear on the Configure Wireless Networks screen by selecting **Networks to access** and then selecting **Only access points** or **Only computer-to-computer**.

Some locations, such as airports or coffee shops, provide an open network but charge a fee to use it. After you connect your smartphone to the network, you need to open Internet Explorer Mobile and register with the Wi-Fi service provider before you can check email or browse the web.

Connecting to a secure network

To set up a connection to a secure network for the first time, do the following:

- 1 Press **Wi-Fi**  (on the side of your smartphone near the stylus slot). What happens next depends on the state of Wi-Fi before you pressed the button:

Wi-Fi was already on: Your smartphone scans for available networks and automatically connects when possible. If your smartphone does not automatically connect and the

Configure Wireless Networks screen appears, highlight the network you want, and press **Connect** (left softkey).

Wi-Fi was off: A notification appears listing three available networks. If the network you want appears, highlight it and press **OK** (left softkey) to connect. If the network you want does not appear, select **Show all networks** to open the Configure Wireless Networks screen, highlight the network you want, and press **Connect** (left softkey).

NOTE As you continue with this procedure, some screen are not displayed, and you can skip those steps.



- 2 Enter the following settings and press **Next** (right softkey):



Network name: Specifies the SSID provided by the system administrator.

Connects to: Sets whether this connection connects to the Internet or to Work. (You may need to select **Work** to access a corporate intranet.)

This is a hidden network: Sets whether the network broadcasts its name. Check this box to connect to hidden networks now and in the future.

This is a device-to-device (ad-hoc) connection: Leave this box unchecked to connect to a Wi-Fi access point (network). Check this box if you're connecting to another device.

- 3 Enter the following settings and press **Next** (right softkey):



Authentication: Sets the method used to identify devices that connect to the network:

- **Open:** Indicates that the network uses open authentication.
- **Shared:** Indicates that the network uses shared authentication.
- **WPA:** Indicates that the network is a WPA network that uses 802.1x protocols.
- **WPA-PSK:** Indicates that the network is a WPA network that requires a password that is shared between the network and your smartphone. This

password is also known as a *preshared key* (PSK).

- **WPA2:** Indicates that the network provides government-grade security with an AES encryption algorithm.
- **WPA2-PSK:** Indicates that the network is a WPA2 network that requires a preshared key (password).

Data Encryption: Sets the encryption method. (The options in this list vary based on your Authentication setting.)

- **Disabled:** Turns data encryption off.
- **WEP:** Turns on the Wired Equivalent Privacy encryption method.
- **TKIP:** Turns on the Temporal Key Integrity Protocol encryption method. This method is often used to encrypt WPA and WPA-PSK connections.
- **AES:** Turns on the Advanced Encryption Standard protocol. (This method is often used to encrypt WPA and WPA-PSK connections.)

The key is automatically provided:

Indicates whether you need to specify the network key and key index provided by your system administrator, or whether the network provides this

information. The availability of these options varies based on your Authentication and Data Encryption settings.

- 4 Enter the following settings and press **Finish** (right softkey):



Use IEEE 802.1x network access control:

Lets you set these parameters if required by the network.

EAP type: Specifies the Extensible Authentication Protocol type.

- 5 Press **OK** (OK icon).

Disconnecting from a network

To disconnect from a Wi-Fi network, do one of the following:

- To save any settings you entered, so that your smartphone automatically connects to this network the next time you are within range and the Wi-Fi feature is turned on, press and hold **Wi-Fi** (Wi-Fi icon) to turn off the Wi-Fi feature.
- To remove the network settings from memory, so that your smartphone does not automatically connect to this network the next time you are within range and the Wi-Fi feature is turned on, press **Menu** (right softkey) and select **Remove Settings**.

Customizing Wi-Fi settings

- Press **Start** (Start icon) and select **Settings**.
- Select the **Connections** tab, and then select **Wi-Fi Prefs** (Wi-Fi icon). The Main and Advanced tabs show the status of the Wi-Fi feature and display information about an active Wi-Fi connection.

- 3 Select the **Power Mode** tab and set any of the following:



Power Save Mode: Adjusts power consumption between maximizing network connection performance and maximizing battery life.

Connection: Sets when the Wi-Fi feature is on and when your smartphone attempts to search for networks.

- **On button press:** Leaves the Wi-Fi feature off until you press **Wi-Fi**  to turn it on. After you turn the Wi-Fi feature on, your smartphone searches for available networks. If a network to which you previously connected is available, your smartphone

automatically connects to that network.

- **Always On:** Leaves the Wi-Fi feature on, and your smartphone searches for available networks whenever the screen is awake. If a network to which you previously connected is available, your smartphone automatically connects to that network. When this mode is enabled, you can prevent your smartphone from searching for networks by pressing and holding **Wi-Fi**  to turn the Wi-Fi feature off.

- 4 Select the **LEAP** tab and do any of the following:



Create a new LEAP entry: Select **New**. A LEAP entry is a security feature that protects the WEP key.

Modify an existing entry: Highlight the entry and select **Modify**. Enter the new information.

Delete an entry: Highlight the entry and select **Delete**.

- 5 Select the **Enroll** tab and set any of the following:

NOTE Ask your network administrator for the username, password, and server name for the Wi-Fi network you want to access.



User: Specifies your username for this Wi-Fi network.



Password: Specifies the password associated with the username you specified on this screen.

Server: Specifies the name of the Internet Information Server (IIS) that stores the security certificate information for this Wi-Fi network.

Retrieve Certificate: Obtains a certificate based on the information you entered.

- 6 Press **OK** .

Customizing advanced Wi-Fi settings

- 1 Press **Start**  and select **Settings**.
- 2 Select the **Connections** tab, and then select **Wi-Fi** .
- 3 On the Wireless tab, press **Menu** (right softkey) and select **Advanced**.

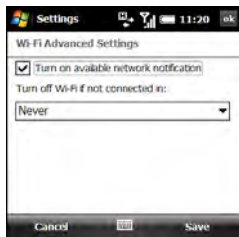

- 4 Select either of the following:

Turn on available network notification:

Sets whether a list of networks appears when you turn on the Wi-Fi feature.

Turn off Wi-Fi if not connected in:

Sets the time interval for turning off the Wi-Fi feature if your smartphone does not connect to a network.

- 5 Press **Save** (right softkey).
- 6 Press **OK** [OK].

Customizing network adapter settings

- 1 Press **Start** [Start] and select **Settings**.
- 2 Select the **Connections** tab, and then select **Wi-Fi** [Wi-Fi].
- 3 Select the **Network Adapters** tab and set any of the following:



My network card connects to: Sets the default network connection type for your smartphone: **Work** or **The Internet**.

Tap an adapter to modify settings:

Lets you edit network adapter information. Select the adapter you want, and then select either of the following tabs:

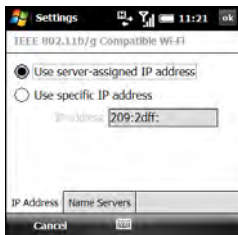

- **IP Address:** Sets whether the server assigns an IP address, or whether you enter a specific IP address.
 - **Name Servers:** Lets you enter the addresses of primary and alternate DNS and WINS servers.
- 4 Press **OK** .

Connecting to devices with Bluetooth® wireless technology

With the Bluetooth® wireless technology on your smartphone, you can connect to a number of Bluetooth devices such as a headset or hands-free car kit, as well as to other phones, handhelds, or piconets. When you connect to another device, you create a partnership (also referred to by terms such as *trusted pair*, *trusted device*, or *pairing*) with that device. If your computer is enabled with Bluetooth wireless technology, you can also synchronize wirelessly or use your phone as a wireless modem.

KEY TERM Partnership Two devices—for example, your smartphone and a hands-free device—that can connect because each device finds the same passkey on the other device. After you form a partnership with a device, you don't need to enter a passkey to connect with that device again.

KEY TERM Piconet An ad-hoc network of devices that uses Bluetooth wireless technology to connect one master device with up to seven active slave devices.

You can create a list of Bluetooth devices that you trust to communicate with your smartphone. When communicating with trusted devices, your smartphone skips the discovery process and creates a secure link as long as the device is within range. Bluetooth range is up to 10 meters (30 feet) in ideal conditions. Performance and range are affected by physical obstacles, radio interference from nearby electronic equipment, and other factors.

When you configure a headset (see [Connecting to a Bluetooth® hands-free device](#)), the headset is automatically added to your trusted device list. Follow the steps

in this section to add other devices to your trusted device list, such as your computer.

DID YOU KNOW? Check your battery level before establishing a Bluetooth connection. If the battery level is low, you can't make a Bluetooth connection.

Entering basic Bluetooth settings

- 1 Press **Start**  and select **Settings**.
- 2 Select the **Connections** tab, and then select **Bluetooth**.
- 3 Select the **Mode** tab and check the **Turn on Bluetooth** box.



DID YOU KNOW? You can also turn the Bluetooth feature on and off from your Today screen. Select your wireless service provider name or **Phone off** to open Comm Manager, select **Bluetooth**, and then press **Exit** (left softkey).

4 Check or uncheck the **Make the device visible to other devices** box.

Check this box to allow Bluetooth devices that are not on your Trusted Device list to request a connection with your device. Your device remains accessible to other devices until you uncheck the box.

Requesting a connection with another Bluetooth device

- 1 If necessary, prepare the device with which you want to connect to accept a new connection. Check the device's documentation for details. Be sure to find out if the device has a predefined passkey that you need to enter on your smartphone in step 8.
- 2 On your smartphone, press **Start**  and select **Settings**.

- 3 Select the **Connections** tab, and then select **Bluetooth**.
- 4 Select the **Mode** tab and check the **Turn on Bluetooth** box.
- 5 Select the **Devices** tab, and then select **Add new device**.



- 6 Wait for your smartphone to search for devices and to display the device list.



- 7 Highlight the device with which you want to connect and press **Next** (right softkey). If the device you want does not appear, select **Refresh**.
- 8 Enter an alphanumeric passkey between 1 and 16 characters long and press **Next** (right softkey).

IMPORTANT Some hands-free devices have a predefined passkey. If your device has a predefined passkey, you can find it in the documentation for that device. Other devices provide a screen where you enter a passkey that you make up. In either case, you must use the same passkey on both your smartphone and the other device. We recommend that where possible, you make up a passkey of 16 alphanumeric characters (letters and numerals only) to improve the security of your smartphone. The longer the passkey, the more difficult it is for the passkey to be deciphered.

- 9 If the passkey is not built-in, enter the same passkey on the other Bluetooth device.
- 10 Press **Done** (left softkey).

You can now communicate with this device whenever it is within range and

the Bluetooth feature on your smartphone is turned on. The range varies greatly depending on environmental factors. The maximum is about 10 meters (30 feet).

TIP To delete the established partnership with a device, go to the Bluetooth Settings screen and select the **Devices** tab. Highlight the connection you want to remove, press and hold **Center** on the 5-way, and then select **Delete**. Select **Yes** to confirm the deletion. The deleted device can no longer automatically connect with your smartphone.

Accepting a connection from another Bluetooth device

- 1 Press **Start**  and select **Settings**.
- 2 Select the **Connections** tab, and then select **Bluetooth**.
- 3 Select the **Mode** tab and check the **Turn on Bluetooth** box.
- 4 If you have already set up a partnership with the transmitting device, your smartphone is ready to receive the info. If you haven't set up a connection, check the **Make this device visible to other devices** box to let the device find

your smartphone and request a connection.

- 5 When prompted to add this device, select **Yes**.
- 6 Enter the same passkey on your smartphone and on the Bluetooth device.
- 7 (Optional) To give the partnership a more meaningful name, select **Display Name** and enter a new name.
- 8 Press **Finish** (right softkey).
- 9 When your smartphone is receiving info, a notification tells you that a transmission is in progress. To stop the transmission, press **Cancel** (right softkey). To close the notification, press **Hide** (left softkey).

Using your device as a wireless modem



Internet Connection Sharing (ICS) is the feature that converts your smartphone into a modem so that you can access the Internet from your computer.

You can set up Internet Connection Sharing in one of two ways:

- Connect your smartphone to your computer using the USB cable.
- If your computer is enabled with Bluetooth wireless technology, set up your smartphone as a wireless modem using the built-in Bluetooth technology.

Setting up a USB Internet Connection Sharing connection



BEFORE YOU BEGIN If you have a Windows XP computer and you synchronize your smartphone with ActiveSync® desktop software on your computer using the USB cable, you must disable the ActiveSync USB connection. Open the ActiveSync window on your computer, select **File > Connection Settings**, and uncheck the **Allow USB connections** box.

- 1 Connect your smartphone to your computer using the USB cable.
- 2 On your smartphone, press **Start**  and select **Programs**.
- 3 Select **Internet Sharing** .

- 4 Select the **PC Connection** list, and then select **USB**.
- 5 Press **Connect** (left softkey).
- 6 On your computer, open your web browser to confirm that you can connect to the Internet.
- 3 You should see an icon representing your smartphone. Double-click this icon to make sure that “Network Access Point” or something similar appears in the list of Bluetooth services.

Creating a Bluetooth Internet Connection Sharing connection

BEFORE YOU BEGIN

- Make sure your smartphone is visible (see [Entering basic Bluetooth settings](#)).
 - Create a partnership between your smartphone and your computer. We recommend that you initiate the partnership from your smartphone (see [Requesting a connection with another Bluetooth device](#)).
- 1 On your computer, double-click the icon to open the Bluetooth connections window. Check the documentation included with your computer for instructions.
 - 2 Select the option to view devices within range.
 - 4 On your smartphone, press **Start**  and select **Programs**.
 - 5 Select **Internet Sharing** .
 - 6 Select the **PC Connection** list, and then select **Bluetooth PAN**.
- NOTE** Keep the default setting on the Network Connection list.
- 7 Press **Connect** (left softkey) and follow the wizard to set up Internet Sharing.
 - 8 On your computer, follow the steps to accept or enable a Bluetooth PAN connection with your smartphone. Check the documentation included with your computer for instructions.

TIP Don't see your smartphone icon or the list of services? Check the documentation included with your computer, or contact your computer manufacturer for help. Different computer models use different terminology for the Bluetooth connection features.

- 9 After you have connected, on your computer, open your web browser to confirm that you can connect to the Internet.



Your photos, videos, and music

Do you have a wallet bulging with photos of friends, family, pets, and your most recent vacation?

Are you tired of carrying both your MP3 player and your phone?

Your Palm® Treo™ Pro smartphone solves both problems. You can keep your favorite photos right on your smartphone—videos, too. And there's no need to carry an expensive MP3 player, because you can play music on your smartphone. Simply transfer songs onto your smartphone or an expansion card (sold separately) and then listen through your stereo headphones.

Benefits

- Never be far from your favorite people, places, and songs
- Arrange your photos, videos, and songs
- Avoid having to use a separate photo viewer, MP3, CD, or mini-disc player

In this chapter

Synchronizing your pictures, videos, and music.	193
Camera.	195
Pictures & Videos.	202
Windows Media Player Mobile	208

Synchronizing your pictures, videos, and music

You can synchronize pictures, videos, and music files between your smartphone and your computer so that changes you make show up on both your computer and your smartphone. How synchronization happens depends on two conditions:

Operating system: Do you use Windows XP or Windows Vista®?

Sync direction: Are you transferring files from your smartphone to your computer, or from your computer to your smartphone?

NOTE The following procedures do not apply to Windows Media Player. To sync files that are in a Windows Media Player library on either your smartphone or your computer, see [Synchronizing Windows Media Player library files](#).

For information about installing desktop sync software and about synchronizing with your computer, see [Installing the desktop sync software](#).

Windows XP

NOTE We strongly recommend using Windows Media Player for synchronizing music files.

Do the following to synchronize pictures, videos, and music files that you **originally captured on or copied to your** smartphone.

BEFORE YOU BEGIN Turn on the option to synchronize files (see [Changing which applications sync](#)).

- 1 Sync normally as you would with the desktop sync software.
- 2 To find synchronized pictures, videos, and music on your computer, go here: C:\Documents and Settings\<<Username>\My Documents\Treo My Documents. This folder has subfolders for My Music, My Pictures, and My Videos.

Do the following to synchronize pictures, videos, and music files that **originate on your computer**.

- 1 Connect your smartphone to your computer with the USB cable.

NOTE Most ActiveSync desktop software options are available only when your smartphone is connected to your computer.

- 2 On your computer, double-click the **ActiveSync**  icon in the taskbar in the lower-right corner of your computer screen to open the ActiveSync desktop software window.

TIP If the ActiveSync icon does not appear in the taskbar, click **Start > Programs > Microsoft ActiveSync** to open the ActiveSync window.

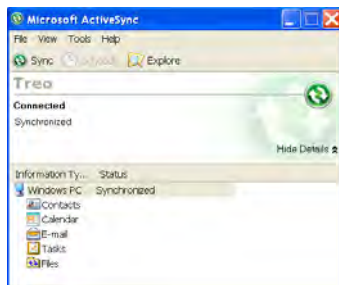

- 3 Under **Information Type**, double-click **Files** to view a list of all synchronized files.

TIP If Files doesn't appear under Information Type, open the **Tools** menu and select **Options**. Make sure the **Files** box is checked.

- 4 Do either of the following:
 - To copy a file from your computer to your smartphone, click **Add**, browse to and highlight the file, and then click **Open**.
 - To delete a file from the Treo My Documents folder on your computer

and from your smartphone, highlight the file name and click **Remove**.

NOTE If you receive an error while synchronizing files, make sure that all of the files you're trying to sync are closed on both your computer and your smartphone.

TIP If a Treo My Documents sync folder has been created on your computer, you can also synchronize by dragging files into the appropriate subfolder under that folder.

Windows Vista

NOTE We strongly recommend using Windows Media Player for synchronizing music files.

Do the following to synchronize pictures, videos, and music files that you **originally captured on or copied to your** smartphone.

- 1 Connect your smartphone to your computer using the USB cable.
- 2 On your computer, click **Start > All Programs > Windows Mobile Device Center**.

3 Select **Connect without setting up your device**.

4 Select **Pictures, Music and Video**.

5 Select **X new pictures/video clips are available for import**.

To synchronize pictures, videos, and music files that **originate on your computer**, use Windows Media Player (see [Synchronizing Windows Media Player library files](#)).

Camera

Your smartphone comes with an easy-to-use, built-in, 2-megapixel camera with up to 8x digital zoom. You can use the camera to take and view pictures and videos and send them to your friends and family. To add a personal touch to your smartphone, use your pictures as your Today screen background and as caller ID images, or use your videos to create video ringtones.

You can receive and view pictures and videos, and send pictures and videos as attachments or multimedia messages (see [Sending a picture or video](#)). Or add a

picture to a contact (see [Adding a contact](#)). You can also move pictures and videos to a computer by synchronizing your smartphone with your computer.

Selecting camera modes

By default, the camera on your smartphone is in picture  mode, to capture standard still images (see [Taking a picture](#)). You can change modes to any of the following:



Video: Captures video clips.



MMS video: Captures video clips suitable for sending as attachments to multimedia messages.



Contacts picture: Captures still images and immediately gives you the option to assign them to a contact.



Panorama: Captures a sequence of still images continuously and allows you to combine them into a panoramic view.



Sports: Captures a sequence of 3, 5, 7, or 10 still images with a single button press.



Burst: Captures a sequence of up to 30 still images while the Center button is being held down.

To switch camera modes, do the following:

- 1 Press and hold the **Side** button.
- 2 Press **Left** ◀ or **Right** ▶ until the icon for the mode you want appears in the upper-left corner of the screen.



* Mode icon

Taking a picture

By default, pictures are stored in the My Pictures folder on your smartphone. If you want to store your pictures on an expansion card, you can change where pictures are stored (see [Customizing your Camera settings](#)). For information on accessing your pictures on your Windows XP computer, see [Windows XP](#).

DID YOU KNOW? Pictures are captured and stored in 16-bit color, JPG format. Resolution settings range from a low end of QQVGA (120 x 160 pixels) to a high end of 2 megapixels (1600 x 1200 pixels). You can change the default setting. See [Customizing your Camera settings](#) for details.

- 1 Press and hold the **Side** button.



TIP If you see the Video or MMS Video icon in the upper-left corner of the screen, press **Left** or **Right** on the 5-way until one of the camera icons appears.

- 2 Aim your smartphone as you would any camera to frame your subject in the smartphone screen.
- 3 (Optional) If the onscreen controls are not displayed, press **Up** ▲ to display the controls and tap the screen with the stylus to open the Quick Settings. Tap any of the following settings repeatedly to toggle among the options for that item:



Resolution: Sets the image quality.

White balance: Specifies the light conditions.

Brightness: Sets the brightness level.

TIP When the Quick Settings are open, press **Left** or **Right** on the 5-way to adjust the brightness setting. If you use the stylus, tap the + or - icon to increase or decrease the brightness setting.

Storage: Specifies whether to save the picture to your smartphone or to an expansion card (sold separately) inserted into your smartphone. The expansion card option appears only if you have an expansion card inserted into your smartphone.

Self-timer: Lets you set a self-timer with a delay of 2 seconds or 10 seconds.

TIP You can set additional options for the camera (see [Customizing your Camera settings](#)).

- (Optional) In all modes except picture mode, with the controls displayed, press **Up** ▲ or **Down** ▼ to change the zoom level. The zoom indicator appears on the left side of the screen.
- Do the following for the mode you are using:

Picture or Contacts picture: Press **Center** ○ to capture the picture or start the self-timer.

Panorama: Press **Center** ○ for each picture you want to take.

Sports: Press and hold **Center** ○ while following the movement of your subject.

Burst: Press and hold **Center** ○ while the camera takes consecutive shots.

- Hold your smartphone still until the picture renders. After the picture has been captured, it appears on the Review screen. Select one of the following:



Go back to the Camera screen to take another picture.



Delete the picture.



Send the picture as an attachment to a multimedia or email message.



View the picture in the Pictures & Videos application (see [Pictures & Videos](#)).



NOTE In Contacts picture mode only, a prompt appears asking if you want to assign the picture to a contact. Select **Yes**, and then select a contact from the list or press **New** (left softkey) to create a new contact for the picture.

TIP Check the **Don't show again** box to turn off the prompt. If you turn the prompt off, you can't save a picture to contacts. To turn the prompt back on, see [Customizing your Camera settings](#).

Recording a video

Videos can be any length, provided you have enough storage space available. By default, videos are stored in the My Pictures folder on your smartphone. If you want to store your videos on an expansion card (sold separately), see [Customizing your Camera settings](#) to change where

videos are stored. For information on accessing your videos on your computer, see [Windows XP](#).

- 1 Press and hold the **Side** button.
- 2 Press **Left** ◀ or **Right** ▶ until the video  or MMS video  icon appears in the upper-left corner of the screen.
- 3 Adjust the position of your smartphone until you see the subject you want to record on the screen.
- 4 (Optional) If the onscreen controls are not displayed, press **Up** ▲ to display the controls and tap the screen to open the Quick Settings. Tap any of the following settings repeatedly to toggle among the options for that item:

Resolution: Sets the image quality.

White balance: Specifies the light conditions.

Brightness: Sets the brightness level.

TIP When the Quick Settings are open, press **Left** or **Right** on the 5-way to adjust the brightness setting. If you use the stylus, first tap the + or - icon to specify whether you want to increase or decrease the brightness setting.

Storage: Specifies whether to save the video to your smartphone or to an expansion card (sold separately) inserted into your smartphone. The expansion card option appears only if you have an expansion card inserted into your smartphone.

TIP You can set additional options for the camera (see [Customizing your Camera settings](#)).

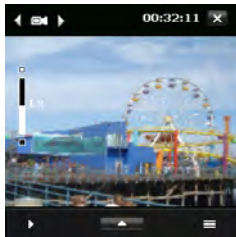

- 5 (Optional) With the controls displayed, press **Up** ▲ or **Down** ▼ to change the zoom level. The zoom indicator appears on the left side of the screen.
- 6 Press **Center** ○ to start recording.

- 7 When you're finished recording, press **Center** ○ to stop recording.

- 8 After the video has been captured, it appears on the Review screen. Select one of the following icons:



Go back to the Camera screen to capture another video.



Delete the video.



Send the video as an attachment to a multimedia or email message.



View the video in Windows Media Player Mobile (see [Playing media files on your smartphone](#)).

Customizing your Camera settings

- 1 Press and hold the **Side** button.
- 2 Tap the **Menu** ≡ icon.
- 3 On the Capture Settings tab, set any of the following options. Not all options appear in all camera modes.

Effect: Sets a special effect such as grayscale or sepia.

Time Stamp (camera, sports, and burst modes only): Sets whether the

Time Stamp (camera, sports, and burst modes only): Sets whether the

date and time are displayed on your captured pictures.

Direction (panorama mode only):

Sets the direction in which images are to be combined into a panorama.

Stitch Count (panorama mode only):

Sets the number of pictures that you want to be combined.

Capture Speed (sports and burst modes only): Sets the speed for capturing still pictures.

Snapshots (sports mode only): Sets the number of shots to be captured with each press of Center .

Quality: Sets the JPG image quality for still pictures.

Metering Mode: Sets whether the camera measures the amount of light around the center of the image or the average amount of light around the entire image to determine the best exposure value.

Storage: Sets whether to save items to your smartphone or to an expansion card (sold separately).

- 4 Select the **Advanced** tab and set any of the following options. Not all options appear in all camera modes.

Capture Format: Sets the format you want for captured still images.

Shutter Sound: Sets whether the camera makes a sound when you press Center .

Grid (camera mode only): Sets whether an onscreen grid appears to help position the subjects of still pictures.

Keep Backlight: Sets whether to turn the backlight on or off when using the camera. This overrides your smartphone backlight settings when you are using the camera.

Review Duration: Sets the time length that a captured picture or image is displayed before it is automatically saved and you return to the Camera screen. Select **No Limit** if you don't want a time limit. Select **No Review** if you want captured items to be saved immediately.

Flicker Adjustment: Sets the rate to reduce flicker on the camera screen.

Record with Audio (video and MMS video modes only): Sets whether to include audio when recording.

Prefix: Sets whether to include the date or the date and time as the prefix in captured item file names. When Default is selected, the prefix for pictures is IMAGE and the prefix for videos is VIDEO.

NOTE If you save pictures to an expansion card (sold separately), you cannot select a prefix. Pictures saved to a card are always given the IMAGE prefix.

Counter: Resets the file-naming counter back to 1.

Recording Limit (video mode only): Sets whether there is a maximum size or length for recorded videos.

Image Properties: Adjusts properties such as contrast, saturation, hue, and sharpness for capture images. After you select the property you want, press

Right ► or **Left** ◀ to increase or decrease the value.

Show Reminder (Contacts picture mode only): Sets whether an alert appears asking whether you want to assign the captured picture to a contact.

5 Press **OK** [OK].

Pictures & Videos

Viewing a picture

In addition to viewing the pictures you capture with the built-in camera, you can view pictures captured on many popular digital cameras or downloaded from the Internet. Your smartphone supports the following picture formats:

- JPG
- PNG
- BMP
- GIF

1 Press **Start** [Start] and select **Pictures & Videos**.

- If your pictures are not displayed in Thumbnail View, tap the **Show** list in the upper-left corner, select **My Documents**, and then select **My Pictures**.
- Select the picture you want to view.
- Press **OK**  to return to Thumbnail View.

Viewing a video

In addition to viewing the videos you capture with the built-in camera, you can view videos captured on many popular digital cameras or streamed from websites. Your smartphone supports and streams the following types of video files:

- MPEG-4
- 3GPP2
- 3GPP
- WMV, WMA, AVI
- RTSP Streaming









- Press **Start**  and select **Pictures & Videos**.
- If your pictures are not displayed in Thumbnail View, tap the **Show** list in the upper-left corner, select **My**

Documents, and then select **My Videos**.

- Select the video you want to view. For more info on viewing videos, see [Playing media files on your smartphone](#).
- Press **OK**  to return to Thumbnail View.

TIP To view pictures or videos in a different folder, tap the **Show** list in the upper-left, and then select the album you want to view.

Viewing a slide show

- Press **Start**  and select **Pictures & Videos**.
- Press **Menu** (right softkey) and select **Play Slide Show**. The slide show plays automatically.
- Press **Center**  to display the slide show toolbar, which you can use to **Rotate** , **Play** , **Pause** , **Reverse** , **Forward** , and **Stop**  the slide show.

Sending a picture or video

You can send a picture or video to other picture-enabled mobile smartphone devices or to an email address as an attachment.

You cannot send copyrighted pictures or videos that appear with a lock icon in Thumbnail View.

- 1 Highlight the picture or video you want to send.
- 2 Press **Menu** (right softkey) and select **Send**.
- 3 Select the option you want to use to send the picture or video: an email account, a multimedia message (MMS), or a voice multimedia message (VoiceMail).
- 4 When the Messaging application opens, address and send the message (see [Creating and sending an email message](#) or [Creating and sending a multimedia message](#)).

TIP You can also beam an item to a nearby device. Press **Menu** (right softkey) and select **Beam**.

TIP If you have set up Windows Live on your smartphone (see [Using Windows Live™](#)), you can send a picture to the web storage space of your Windows Live account. From there, you can share the picture with other web users. Highlight the picture, press **Menu** (right softkey), and select **Send to your space**.

Creating a caller ID picture

You can add a picture to a contact entry when you create the entry (see [Adding a contact](#)). Follow these steps if you want to add a picture to an existing contact, or to replace an existing contact's picture.

- 1 Highlight the picture you want to use as a caller ID picture.
- 2 Press **Menu** (right softkey) and select **Save to Contact**.
- 3 Select the contact to whom you want to assign the picture, or press **New** (left softkey) to create a new contact to whom you want to assign the picture.

Organizing pictures and videos

You can move or copy pictures and videos to other folders or between your smartphone and an expansion card.

- 1 Highlight the picture or video you want to move or copy.
- 2 Do one of the following:

Move the picture or video: Press **Menu** (right softkey) and select **Edit > Cut**.

Copy the picture or video: Press **Menu** (right softkey) and select **Edit > Copy**.

TIP To create a new location for storing the picture or video, press **Menu** (right softkey) and select **Edit > New Folder**.

- 3 Tap the **Show** list in the upper-left and select the location where you want to place the picture or video.
- 4 Press **Menu** (right softkey) and select **Edit > Paste**.

You can also view a specific folder or expansion card and arrange the pictures and videos by name, date, or size.

- 1 Tap the **Show** list in the upper-left and select the folder you want to view.
- 2 Tap the **Sort By** list in the upper-right and select the sort method: **Name**, **Date**, or **Size**.

Using a picture as the Today screen background

- 1 Highlight the picture you want to use.
- 2 Press **Menu** (right softkey) and select **Set as Today Background**.
- 3 Select the **Transparency level** list and select the appropriate level. Use a higher percentage for a more transparent picture and a lower percentage for a more opaque picture.
- 4 Press **OK**  to return to Thumbnail View.

Editing a picture

For more extensive edits, download your picture or video to your computer and edit it in your favorite graphics program. Then sync the picture or video back to your smartphone.

- 1 Select the picture you want to edit.
- 2 Press **Menu** (right softkey) and select **Edit**.
- 3 Do any of the following:
 - To rotate the picture 90 degrees, press **Rotate** (left softkey).
 - To crop the picture, press **Menu** (right softkey) and select **Crop**. Tap and drag the stylus to highlight the area to crop. Tap inside the box to crop the picture.
 - To adjust the brightness and contrast levels of the picture, press **Menu** (right softkey) and select **AutoCorrect**.
 - To undo an edit, press **Menu** (right softkey) and select **Undo**.
 - To cancel all unsaved edits you made to the picture, press **Menu** (right softkey) and select **Revert to Saved**.
- 4 To save your edited picture, press **Menu** (right softkey) and select **Save As**. Enter a new name for the picture and press **OK** .

Deleting a picture or video

- 1 Highlight the picture or video you want to delete.
- 2 Press **Menu** (right softkey) and select **Delete**.
- 3 Select **Yes** to confirm the deletion.

Renaming a picture or video

- 1 Highlight the picture or video you want to rename.
- 2 Press **Menu** (right softkey) and select **Tools > Properties**.
- 3 Enter a new name for the picture or video.
- 4 Press **OK**  to return to Thumbnail View.

Customizing picture playback settings

- 1 Press **Start**  and select **Pictures & Videos**.
- 2 Press **Menu** (right softkey) and select **Tools > Options**.

- 3 On the General tab, set any of the following options:



Use this picture size: Sets the size of pictures you send with the Messaging application.

When rotating a picture, rotate 90 degrees: Sets the direction in which pictures rotate.

- 4 Select the **Slide Show** tab, and set any of the following options:

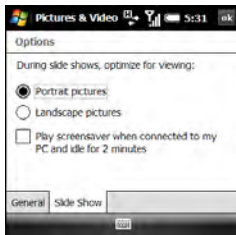

During slide shows, optimize for viewing: Sets whether pictures are optimized for portrait or landscape format during slide shows.

Play screensaver when connected to my PC and idle for 2 minutes: Sets whether the pictures in your My Pictures folder are used as a screensaver when your smartphone is connected to your computer and ActiveSync® desktop software is not running.

- 5 Press **OK**  to return to Thumbnail View.

Windows Media Player Mobile

Windows Media Player Mobile can play music, audio, and video files that are stored on your smartphone or on an expansion card (sold separately) in any of the following file formats:

- WMA
- WMV
- MP3
- 3GP
- AAC
- AAC+
- MPEG-4

DID YOU KNOW? You can also download animated GIF files and view them in Internet Explorer Mobile.

IMPORTANT You must have QuickTime Player version 6.5 or later installed on your computer to play videos recorded by your smartphone. You can download the videos from an expansion card or you can click the

video thumbnail after synchronizing the files.

You can listen to these music, audio, and video files through the speaker on the back of your smartphone or through stereo headphones.

Synchronizing Windows Media Player library files

Use the Sync feature in the desktop version of Windows Media Player to transfer digital music, audio, video, and playlist files between your computer and an expansion card or your smartphone. Using the Sync feature ensures that the files are transferred correctly.

TIP For tips on using the desktop version of Windows Media Player, go to the Help menu in Windows Media Player on your computer.

BEFORE YOU BEGIN Do the following:

- Be sure you have Windows Media Player 10 or later installed on your computer. On a Windows XP computer, Windows Media Player 10 must be installed on your computer before you

install ActiveSync desktop software. You can install ActiveSync desktop software from your smartphone. (If you are having trouble, see [My video and music files won't sync.](#)) If you need to install Windows Media Player, you can download it for free from microsoft.com.

NOTE Windows Media Player 11 is already installed on Windows Vista computers.

- To sync Windows Media Player files with your computer, set the Media sync option on your smartphone (see [Changing which applications sync.](#))
- 1 On your computer, open Windows Media Player.
- 2 (Optional) If you're transferring media files to an expansion card, insert a 32MB or larger expansion card into your smartphone.
- 3 Connect your smartphone to your computer with the USB sync cable.
- 4 Do one of the following:

Windows Media Player 10: When the Device Setup Wizard opens on your computer, click **Automatic**. Check the

Customize the playlists that will be synchronized box.

Windows Media Player 11: Select the arrow below the **Library** tab, and then select the type of item you want to synchronize: pictures, music, or videos. Select the arrow below the **Sync** tab, and then select **Treo > Set Up Sync**. Check the **Sync this device automatically** box. To sync with an expansion card, select the arrow below the Sync tab, and then select **Storage Card > Set Up Sync**.

- 5 Select the playlists you want to sync. On a Windows Vista computer, select the **All Photos** and **All Videos** playlists to synchronize pictures and videos between your smartphone and your computer.

NOTE If the playlist you want does not appear, the items you want to synchronize may reside in a folder that does not sync with Windows Media Player. Sync those items by following the correct sync procedure described in [Synchronizing your pictures, videos, and music.](#)

- 6 Click **Finish** to begin the transfer. If you are transferring files to an expansion card, be patient; transferring media files to an expansion card can take several minutes.

To find your synchronized files, update the library in Windows Media Player. The files appear in the updated libraries.

Playing media files on your smartphone

- 1 Press **Start**  and select **Windows Media Player**.
- 2 If the Library screen is not displayed, press **Menu** (right softkey) and select **Library**.
- 3 Tap the **Library** list in the upper-left and select the library you want to use.

TIP To play a file that is not in a library, go to the Library screen, press **Menu**, and select **Open File**.

- 4 Select the category containing the media file you want to play. Continue selecting categories until the list of individual items (videos, songs, albums, or artist names) appears.

TIP If you can't find a item you want, update the library (see [Working with libraries](#)).

- 5 Select the item you want to play (such as a song, album, or artist name).
- 6 Press **Play** (left softkey). See the next page for playback controls.
- 7 Press **Menu** (right softkey) and select any of the following during playback:

Library: Displays the Library screen so you can select a different song to play.

Shuffle/Repeat > Shuffle: Plays the Now Playing playlist in random order. A check appears next to this command when it is on.



Shuffle/Repeat > Repeat: Plays the Now Playing playlist repeatedly. A check appears next to this command when it is on.



Stop: Ends playback.

Playback controls

Use any of the following onscreen controls during playback:

 or **Center**  plays the current file.

 or **Center**  pauses the current file.

 or **Left**  skips to the beginning of the current file or to the previous file.

 or **Right**  skips to the next file.

 sets the point from which playback begins. Tap and drag the slider to change the current position.

 or **Volume button** increases the volume level.

 or **Volume button** decreases the volume level.

 turns the sound on or off.

 displays a video using the full screen.

 displays a website where you can find music and videos to play.

 indicates the rating of the current file. Select the star to change the rating.

DID YOU KNOW? You can play streaming files from the web. To play an MMS (Microsoft Media Streaming) file, press **Menu** on the Library screen and select **Open URL**. Select **URL** and enter the website address, or select **History** and select a site you've visited before.

DID YOU KNOW? If you close the Windows Media Player Mobile window, your music continues to play in the background.

Working with libraries

A library represents each of the storage locations available to Windows Media Player Mobile, such as your smartphone (My Device) or an optional expansion card, sold separately (My Storage Card). Each library contains links to the media files in that location. Windows Media Player Mobile usually updates the My Device library automatically, but you must manually update the My Storage Card library.

TIP If you don't see a media file that you added, manually update the library.

- 1 Press **Start**  and select **Windows Media Player**.
- 2 If the Library screen is not displayed, press **Menu** (right softkey) and select **Library**.
- 3 Press **Menu** (right softkey) and select **Update Library**.
- 4 Wait for the files to be added, and then select **Done**.

TIP To delete an item from a library, highlight the item and then press and hold **Center** on the 5-way to open the shortcut menu. Select **Delete from Library**, and select **Yes** to confirm the deletion.

DID YOU KNOW? If you move files between your smartphone and an expansion card, be sure to update your libraries, or you won't be able to see the files in their new location.

Working with playlists

A playlist is a list of media files that play in a specific order. You can use playlists to group audio files together or video files together for convenient playback. For example, in the desktop Windows Media Player, you can create a playlist of upbeat songs for when you exercise and a playlist

of soothing songs for a long flight. When you synchronize, your favorite playlists are automatically copied to your smartphone. Your playlists appear in your libraries (in the My Playlists category).

A temporary playlist, called Now Playing, appears on the Now Playing menu. It lists the currently playing file, as well as any files that are queued up to play next. You can add to, modify, or clear the files on the Now Playing playlist.

- 1 Go to the Now Playing screen:
 - If you are on the Library screen, select the **Now Playing** category.
 - If you are on the Playback screen, press **Now Playing** (left softkey).

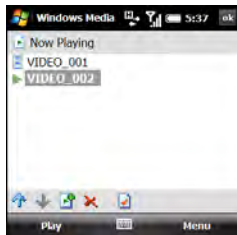

2 Do any of the following:

- To move a file up or down one slot, highlight the file and select **Move Up** ↑ or **Move Down** ↓.

TIP You can also move a file in the Now Playing playlist by tapping and dragging it to a new position.

- To add a file, highlight the file, select **Add** ➕, press **Menu** (right softkey), and select **Queue Up**.
- To delete a file from the playlist, highlight the file and select **Remove** ✖.
- To view more info about a file, highlight the file and select **Properties** ⓘ.
- To remove all items from the Now Playing playlist, press **Menu** (right softkey) and select **Clear Now Playing**.

Customizing Windows Media Player Mobile

- If you are on any screen other than the Playback screen, press **OK** (Ⓞ) to go to the Playback screen.
- Press **Menu** (right softkey) and select **Options**.
- On the Playback tab, set any of the following options:

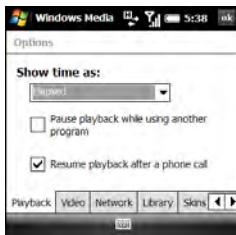

Show time as: Sets whether the time remaining or time elapsed appears in the Playback screen.

Pause playback while using another program: Sets whether playback continues if you switch to another application.

Resume playback after a phone call:

Sets whether playback continues after you finish a phone call.

- 4 Select the **Video** tab and set any of the following options:

Play video in full screen: Sets whether videos automatically play in full screen format.

Scale to fit window: Sets whether videos are automatically scaled to fit the Playback screen.

- 5 Select the **Network** tab and set the following options:

Protocol: Enables and disables the available protocols. You must select at least one protocol. You can also set a UDP Port.

Internet connection speed: Specifies the speed of your network connection, and specifies whether you want the device to detect connection speed.

- 6 Select the **Library** tab and set whether you want to see the Library or Playback screen when you open Windows Media Player Mobile.

- 7 Select the **Skins** tab and select **Previous** or **Next** to set the player's background.
- 8 Select the **Buttons** tab to change any of the available button settings:

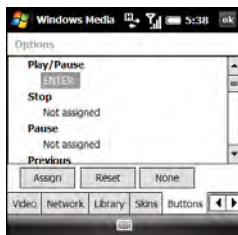

- To assign a button, highlight the item you want to set, select **Assign**, and press the button you want to use for that item.
 - To restore an item's factory setting, highlight the item and select **Reset**.
 - To unassign an item, highlight the item and select **None**.
- 9 Press **OK** [OK].



Your personal information organizer

Say good-bye to paper calendars and throw away those scribbled to-do lists. Your Palm® Treo™ Pro smartphone is all you need to organize your personal information and keep it with you wherever you go.

You never lose your information, even if your battery is completely drained. All your personal information is backed up each time you synchronize, and your information is kept private when you use the security features available on your smartphone. Also, you can easily share info with others electronically.

Benefits

- Track current, future, and past appointments
- Set reminders for appointments, birthdays, important tasks, and more
- Make to-do lists that get done

In this chapter

Contacts	217
Calendar	222
Tasks	228
Notes	231

Contacts

Adding a contact

1 Go to your Today screen and press **Contacts** (left softkey).

2 Press **New** (left softkey).

3 Select the type of contact to create:

Outlook Contact: This type of contact is stored in the Contacts application on your smartphone and synchronizes with the Contacts application in Microsoft Office Outlook® on your computer.

SIM Contact: This type of contact is stored on the SIM card in your smartphone and does not synchronize. If you use the SIM card with another smartphone, you can access any contacts on the SIM card (see [Using SIM Manager](#)).

TIP If you have set up a Windows Live account (see [Using Windows Live™](#)), you can save the contact as a Windows Live contact. A Windows Live contact synchronizes with your Windows Live contacts list but not with Microsoft Outlook on your computer

4 Use the **5-way** navigator to move between fields as you enter information.

NOTE For a SIM contact, you can enter a name and phone number only.

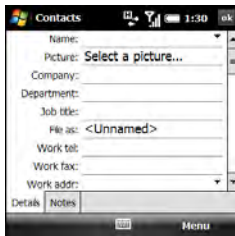



TIP Take some time to scroll down through all the fields in a new contact. There are fields for multiple addresses, phone numbers, email addresses, and much more.

TIP Be sure to enter mobile numbers and email addresses in the correct fields so that Messaging can find this info when you address a message and Calendar can find your contacts when you want to invite them to meetings.

Here are some helpful tips for entering info:

- To enter complete name or address (work, home, or other) information, tap the arrow on the right side of the line and enter the information in the box that appears. When finished, tap outside the box to accept the information and close the box.
- To add a caller ID picture that displays when that person calls, select **Picture**, and then select **Camera** and take a picture, or select an existing picture from Thumbnail View.
- To assign a ringtone to the entry, select **Ring tone** and select a tone.

- To assign the entry to one or more categories, select **Categories** and then check the categories under which you want this entry to appear. To add a new category, press **New** (left softkey), enter the category name, and press **OK** .

- 5 (Optional) To add a note to an entry, select the **Notes** tab.
- 6 After you have entered all the information, press **OK** .

DID YOU KNOW? If you want to create a new contact that shares information with an existing contact—for example, they both work at the same company—you can make a copy of the first contact and then edit only the fields you need to change for the new contact. In the contacts list, highlight the first contact, press **Menu** (right softkey), and then select **Copy Contact**.

Viewing or changing contact information

- 1 Go to your Today screen and press **Contacts** (left softkey).
- 2 In the Contacts list (viewed by name), begin entering any combination of letters from the contact's first and/or

last name. If you use both first- and last-name letters, separate them by a space.

You can type letters from the last name first. For example, entering SM finds both Smilla Anderson and John Smith. Entering SM AN finds both Smilla Anderson and Ann Smith.

- 3 Select the entry you want to open.

TIP You can also find a contact by tapping the first letter of the first or last name in the alphabetical index at the top of the Contacts list screen.

DID YOU KNOW? When you select a contact entry, you are presented with several options for contacting the person, depending on what information you have entered for the contact. For example, you may see options for calling a number associated with the contact, sending an email to the contact's email address, or calling the last number you dialed to call the contact. Select a phone number to dial, or select a messaging option to create a new message addressed to the contact.

- 4 Press **Menu** (right softkey) and select **Edit**.

- 5 Make changes to the entry as necessary.
- 6 Press **OK** .

DID YOU KNOW? You can find a contact by company name. Open Contacts, press **Menu** (right softkey), and select **View By > Company**. Select a company name to see the contacts who work there.

TIP To view a particular group of contacts, press **Menu** (right softkey), select **Filter**, and then select the category you want to view.

TIP You can quickly send a text message to a contact from within the Contacts application. Select the contact name, press **Menu** (right softkey), and select **Send Text Message**.

Deleting a contact

- 1 Go to your Today screen and press **Contacts** (left softkey).
- 2 In the Contacts list, highlight the contact you want to delete.
- 3 Press **Menu** (right softkey) and select **Delete Contact**.
- 4 Select **Yes** to confirm the deletion.

Customizing Contacts

- 1 Go to your Today screen and press **Contacts** (left softkey).
- 2 Go to the Contacts list.
- 3 Press **Menu** (right softkey) and select **Options**.
- 4 Set any of the following options:

Show alphabetical index: Displays the alphabet at the top of the Contacts list. You can use this index to find a contact.

Show contact names only: Enables you to fit more names on the Contacts list by hiding everything but the contact's name.

Area code: Specifies the default area code for new contact entries.

- 5 Press **OK** [OK].

Finding a contact in an online address book

In addition to having contacts on your device, you can also access contact information from your organization's online address book or Global Address List (GAL).

BEFORE YOU BEGIN Do the following:

- Make sure you are accessing Exchange Server 2007, or Exchange Server 2003 upgraded to Service Pack 2.
- Add access to the online address book to your smartphone. See [Adding an online address book](#).
- After adding the online address book, you must synchronize with the Exchange server in order for the Company Directory option to appear.

- 1 Go to your Today screen and press **Contacts** (left softkey).
- 2 Press **Menu** (right softkey), select **Company Directory**, enter the name of the contact, and select **Search**.

Sending a contact

Your smartphone provides multiple options for sending a contact's information to someone else.

- 1 Go to your Today screen and press **Contacts** (left softkey).
- 2 In the Contacts list, highlight the contact you want to send.

- 3 Press **Menu** (right softkey) and select one of the following options:

Beam a contact to a nearby device:

Select **Send Contact > Beam**, and then select the receiving device.

Send a text message containing the contact information:

Select **Send Contact > Text Messages**. Select which contact information you want to send, and press **Done** (left softkey).

Address the text message and press **Send** (left softkey).

Send a multimedia message containing the contact information:

Select **Send as vCard**. Address the multimedia message and press **Send** (left softkey).

TIP You can also send a message to the highlighted contact. Press **Menu** (right softkey) and select **Send MMS (Mobile)** or **Send VoiceMail (Mobile)**.

Using SIM Manager

You can manage the contacts on your SIM card, including deleting numbers and transferring numbers between the card and the Contacts application on your smartphone.

- 1 Press **Start**  and select **Programs**.
- 2 Select **SIM Manager** .

TIP You can also open SIM Manager from within the Contacts application. On the Contacts list, press **Menu** (right softkey) and select **SIM Manager**.

- 3 Highlight the contact you want.
- 4 Press **Menu** (right softkey) and select the option you want to edit the contact's information, delete the contact, copy it to the Contacts application, and more.

TIP You can create a new SIM contact directly in SIM Manager by pressing **New** (left softkey).

- 5 Press **OK** .

TIP If a contact has more than one phone number, you can automatically copy one or more of the numbers to the SIM card. In SIM Manager, press **Menu** (right softkey) and select **Tools > Options**. Check the boxes next to the numbers you want automatically copied to the SIM card and press **OK**.

Calendar

Displaying your calendar

- 1 Press **Calendar** .
- 2 Press **Menu** (right softkey) and select **View**.
- 3 Select one of the following views:

Agenda: Shows your daily schedule in list format. Upcoming appointments are bold; past appointments are dimmed.

Day: Shows your daily schedule in day-planner format. Day View displays a horizontal time strip at the top to show at a glance when you have appointments.

Week: Shows your schedule for an entire week.

DID YOU KNOW? If your schedule contains a conflict—two appointments that overlap—you can see the conflict in both Day View and Week View.

Month: Shows your schedule for a whole month.

- ▣ A morning appointment
- ▣ An afternoon appointment
- Both morning and afternoon appointments
- An all-day event

Year: Shows a calendar for a six-month period.

TIP To switch views, press the **left** softkey. Don't confuse the view name displayed above the left softkey with the current view. The left softkey displays the name of the next view you see when you press the key.

- 4 Use the **5-way** to move to another day, week, month, or year (depending on the current view).

Creating an appointment

- 1 Press **Calendar** .
- 2 Press **Menu** (right softkey) and select **New Appointment**.

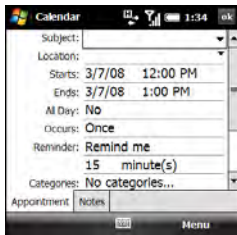

- 3 Enter a subject (description) and a location.
- 4 Select **Starts** and select the starting date and time.
- 5 Select **Ends** and select the ending date and time.
- 6 Press **OK** .

TIP To “pencil in” an appointment, open the appointment, select **Status**, and then select **Tentative**.

TIP You can display your appointments on your Today screen (see [Selecting which items appear on your Today screen](#)).

Adding an alarm reminder to an event

- 1 Create an event and then select it.
- 2 Press **Menu** (right softkey) and select **Edit**.
- 3 Select **Reminder**, and then select **Remind me**.
- 4 Enter the number of minutes, hours, days, or weeks before the event you would like to receive the alarm.

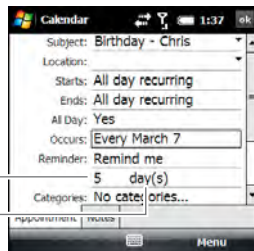

- 1 Number of time units
- 2 Type of time units
- 5 Press **OK** .

Creating an untimed event

An untimed event, such as a birthday, anniversary, or vacation, does not occur at a particular time of day. These events appear as banners at the top of your calendar; they don't occupy blocks of time. For example, "Submit Final Draft" in the screenshot shown below is an untimed event.

DID YOU KNOW? An untimed event can last longer than a day.

- 1 Press **Calendar** .

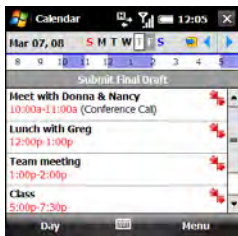

- 2 Press **Menu** (right softkey) and select **New Appointment**.
- 3 Enter a subject (description).

- 4 Select the starting and ending dates.
- 5 Select **All Day**, and then select **Yes**.
- 6 Press **OK** .

Scheduling a repeating appointment

- 1 Create an appointment or untimed event and then select it.
- 2 Press **Menu** (right softkey) and select **Edit**.
- 3 Select **Occurs**, and then select a repeat pattern. To create a repeat pattern, select **Edit pattern** and follow the onscreen instructions.

TIP To enter a birthday or an anniversary, create an untimed event that repeats every year.

- 4 Press **OK** .

Sending a meeting request

You can email meeting invitations to contacts who use Outlook or Outlook Mobile.

BEFORE YOU BEGIN Create contact entries with email addresses for the people you want to invite to a meeting (see [Adding](#)

[a contact](#)). You can't access contact entries without email addresses from your calendar.

- 1 Create an event and then select it.
- 2 Press **Menu** (right softkey) and select **Edit**.
- 3 Select **Attendees**.
- 4 Select **Add Required Attendee**, and then select the name of the contact you want to invite. To invite other attendees, select **Add Required Attendee**, and then select the names.
- 5 (Optional) To invite optional attendees, select **Add Optional Attendee**, and then select the names.

DID YOU KNOW? If you are using Exchange Server 2007, or Exchange Server 2003 with Service Pack 2, you can use your corporate Global Address List to find contact information for an attendee. Select **Attendees**, select **Add Required Attendee** or **Add Optional Attendee**, press **Menu** (right softkey), and then select **Company Directory**. Enter the name of the attendee and select **Find**.

- 6 Press **OK** .

The next time you synchronize, the meeting request is sent to the attendees. When attendees accept your request, the meeting is automatically added to their schedules. When you receive their response, your calendar is updated as well.

Replying to a meeting request

You receive and reply to meeting requests in the Messaging application (see [Working with meeting invitations](#)). If you accept or tentatively accept an invitation, it shows up as an appointment in your Calendar.

Marking an event as sensitive

If other people have access to your Outlook calendar on your computer and you don't want them to see an appointment, you can mark that appointment as private to hide it from other Outlook users.

- 1 Create an event and then select it.
- 2 Press **Menu** (right softkey) and select **Edit**.

- 3 Select **Sensitivity**, and then select one of the following:

Personal: Displays the event on your smartphone and on your computer. Meeting attendees or recipients see “Please treat this as Personal” near the top of an open appointment.

Private: Displays the event on your smartphone and on your computer. Meeting attendees or recipients see “Please treat this as Private” near the top of an open appointment. If you sync with an Exchange server, other users who can access your folders can’t see your private events; they see private events as unavailable time slots.

Confidential: Displays the event on your smartphone and on your computer. Meeting attendees or recipients see “Please treat this as Confidential” near the top of an open appointment.

TIP If you don’t see an option on the screen, press **Down** on the 5-way to scroll to other options. For example, when editing an event, you don’t see the Sensitivity option until you scroll toward the bottom of the entry.

- 4 Press **OK** .

Organizing your schedule

Use categories to view various types of events.

- 1 Create an event and then select it.
- 2 Press **Menu** (right softkey) and select **Edit**.
- 3 Select **Categories** and check the categories that apply to this event. To add a new category, press **New** (left softkey), enter the category name, and press **OK** .

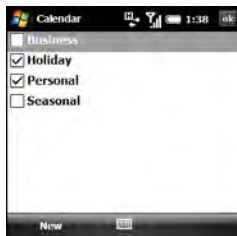

- 4 Press **OK**  two more times.
- 5 After you assign events to categories, press **Menu** (right softkey) and select **Filter**.

- 6 Select the type of events you want to view.

TIP Wonder why you're not seeing all the events in your day? Check to make sure that the filter is set to All Appointments.

Deleting an event

- 1 Highlight the event you want to delete.
- 2 Press **Menu** (right softkey) and select **Delete Appointment**.
- 3 Select **Yes** to confirm the deletion.

Customizing Calendar

- 1 Press **Menu** (right softkey) and select **Tools > Options**.
- 2 On the General tab, set any of the following options:

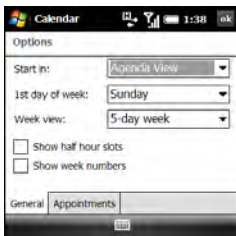

Start in: Specifies which view is displayed when you open Calendar.

1st day of week: Specifies Sunday or Monday as the first day of the week for all Calendar views.

Week view: Specifies whether five, six, or seven days appear in Week View.

Show half hour slots: Specifies whether time slots appear in hour or half-hour increments in Day View and Week View.

Show week numbers: Specifies whether week numbers (1–52) appear in Week View.

- 3 Select the **Appointments** tab and set any of the following options:

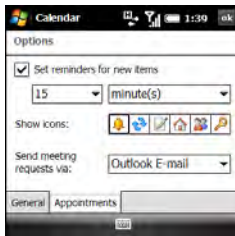

Set reminders for new items:

Specifies whether a reminder is automatically added to new events and how long before the event the reminder appears. You can override this setting for individual events.

Show icons: Specifies which icons appear next to events.

 The event has a reminder.

 The event repeats in a specified pattern.

 The event has a note attached.

 A location has been assigned to the event.

 The event is a meeting.

 The event is marked private.

TIP Not all icons appear in all Calendar views.

Send meeting requests via: Specifies the email account used to send meeting requests.

- 4 Press **OK** .

Sending an appointment

- 1 Press **Calendar** .
- 2 Highlight the appointment you want to send.
- 3 Select one of the following:

Beam an appointment to a nearby device: Press **Menu** (right softkey) and select **Beam Appointment**. Select the receiving device.

Send a multimedia message containing the appointment: Press **Menu** (right softkey) and select **Send as vCalendar**. Address the multimedia message and press **Send** (left softkey).

Tasks

You can use Tasks to remind you of tasks you need to complete and to keep a record of completed tasks.

Adding a task

- 1 Press **Start**  and select **Programs**.
- 2 Select **Tasks** .

- 3 Press **Menu** (right softkey) and select **New Task**.
- 4 Enter a description of the task in the Subject field.
- 5 Set any of the following:

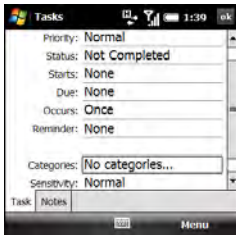

Priority: Specifies the priority level for this task. Later you can arrange your tasks based on the importance of each task.

Status: Indicates whether the task is now completed.

Starts: Specifies when the task begins.

Due: Specifies the due date for the task.

Occurs: Indicates if the task repeats at regular intervals and how often it repeats.

Reminder: Sets an alarm for this task and indicates when you want to be reminded.

Categories: Assigns the task to one or more categories. To add a new category, press **New** (left softkey), enter the category name, and press **OK** [OK].

Sensitivity: Marks this task as Normal, Personal, Private, or Confidential (see [Marking an event as sensitive](#) for descriptions of these terms).

- 6 (Optional) Select the **Notes** tab and enter additional text for the task.
- 7 Press **OK** [OK].

TIP You can also add a task by selecting the Tasks entry bar at the top of the task list screen, entering the task description, and pressing **Center** on the 5-way. Select the icons to the left of the bar to set the task as high or low priority.

TIP You can display your tasks on your Today screen (see [Selecting which items appear on your Today screen](#)).

Checking off a task

- 1 Highlight the task you want to check off.

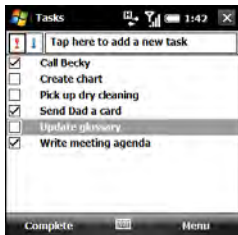

- 2 Press **Complete** (left softkey).

TIP You can also mark a task complete by tapping the check box next to the task on the Tasks list.

DID YOU KNOW? Overdue tasks appear in red.

Organizing your tasks

- 1 In the Tasks list, press **Menu** (right softkey) and select **Filter**.
- 2 Select which tasks you want to view: **All Tasks, Recently Viewed, No Categories, Active Tasks, Completed Tasks**, or a specific category, such as Business or Personal.
- 3 Press **Menu** (right softkey) and select **Sort By**.
- 4 Select the sort method: **Status, Priority, Subject, Start Date, or Due Date**.

Deleting a task

- 1 Highlight the task you want to delete.
- 2 Press **Menu** (right softkey) and select **Delete Task**.
- 3 Select **Yes** to confirm the deletion.

Customizing Tasks

- 1 Go to the Tasks list.
- 2 Press **Menu** (right softkey) and select **Options**.

- 3 Set any of the following options:

Set reminders for new items:

Automatically adds a reminder to new tasks. The default reminder is set to 8:00 on the morning the task is due. You can override this setting for individual tasks using the Reminder field on the task entry screen.

Show start and due dates: Displays task start and due dates in the Tasks list.

Show Tasks entry bar: Displays the Tasks entry bar at the top of the Tasks list.



- 4 Press **OK** .

Notes

Notes are a great way to capture thoughts, questions, and meeting notes on your smartphone. You can also create a voice note or add a recording to an existing note.

BEFORE YOU BEGIN On a Windows XP computer, to take advantage of all the sync features available in the Notes application, install ActiveSync desktop software from your smartphone (see [Installing the desktop sync software](#)).

Creating a note

- 1 Press **Start**  and select **Programs**.
- 2 Select **Notes** .
- 3 Press **New** (left softkey).
- 4 Do one of the following:

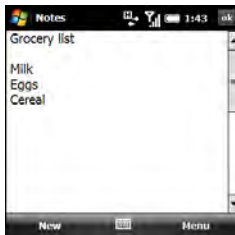

- Type the text with the keyboard.
- If you turned on writing mode (see [Customizing Notes](#)), write the text with the stylus.

- Press **Menu** (right softkey), select **Draw**, and draw a sketch with the stylus, crossing at least three ruled lines.

5 Press **OK** [OK].

Creating a voice note

1 Press **Start** [Start] and select **Programs**.

2 Select **Notes** [Notes].

3 Do one of the following:

To create a new voice note: Press **New** (left softkey).

To add a voice recording to an existing note: Open the note to which you want to add the recording.

4 If the voice note controls are not visible at the bottom of the screen, press **Menu** (right softkey) and select **View Recording Toolbar**.

5 Tap the **Record** [Record] icon.

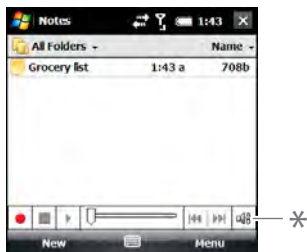

* Voice note controls

- 6 Speak into the microphone on your smartphone, or hold it close to another sound source.
- 7 When you finish recording, tap the **Stop** [Stop] icon. A **Recording** [Recording] icon appears in the note or note list, depending on where you recorded the note.
- 8 Press **OK** [OK].

DID YOU KNOW? You can add several voice notes within a single note.

TIP To play a recording, select the voice note in the Notes list, or open the note containing the recording and tap the **Recording** icon. Tap the controls at the bottom of the screen to control playback and volume.

Creating a note from a template

- 1 Go to the **Notes** list.
- 2 Tap the **Show** list in the upper-left and select **Templates**. If you do not see the Templates folder, select **More Folders**.
- 3 Open the template you want to use.
- 4 Enter the information.
- 5 Press **OK** .
- 6 Rename the note and move it to the appropriate folder. See [Organizing your notes](#) for details.

TIP To create a new template, open the note you want to save as a template. Press **Menu** (right softkey) and select **Tools > Rename/Move**. Select **Name** and enter a name for the template. Select the **Folder** list and select **Templates**. Press **OK**.

Organizing your notes

You can rename your notes, move notes to another folder, and move notes between your smartphone and an expansion card (sold separately) inserted into your smartphone.

- 1 Go to the Notes list and highlight a note you want to move or rename.
- 2 Press **Menu** (right softkey) and select **Rename/Move**.
- 3 Select **Name** and enter a new name for the note.
- 4 Select **Folder**, and then select the folder in which you want to store the note.
- 5 Select **Location**, and then select **Main memory** or **Storage Card**. The Storage Card option appears only if you have an expansion card (sold separately) inserted into your smartphone.
- 6 Press **OK** .

TIP To create a new folder, go to the Notes list, tap the **Show** list in the upper-left, and select **Add/Delete**. Select **New**, enter a name for the folder, and press **OK**.

Deleting a note

- 1 Go to the Notes list and highlight the note you want to delete.
- 2 Press **Menu** (right softkey) and select **Delete**.
- 3 Select **Yes** to confirm the deletion.

Customizing Notes

- 1 Go to the Notes list.
- 2 Press **Menu** (right softkey) and select **Options**.
- 3 Set any of the following options:

Default mode: Makes the default entry mode either Writing or Typing. The default is Typing; if you change it to Writing, you can write notes directly on the screen using the stylus.

Default template: Specifies the default template for new notes.

Save to: Indicates the default location where new notes are stored.

Record button action: Specifies what happens when you press and hold the Side button to record a voice note while in another application: whether the Notes application opens or whether you stay in the current application. This option applies only if you have changed the function of the Side button to open Notes (see [Reassigning buttons](#))

TIP Tap **Global Input Options** to set options for entering text in any application (see [Setting input options](#)).

- 4 Press **OK** .



Your Microsoft Office and other document tools

Your Palm® Treo™ Pro smartphone enables you to take your office with you—including your Microsoft Office files. With Microsoft Office Mobile®, you can carry, create, view, and edit Microsoft Word, Excel®, and OneNote files directly on your smartphone. You can also view, carry, and manage PowerPoint® files on your smartphone. You can keep updated copies of the files on both your smartphone and your computer so that you can work on them in the most convenient location at any time.

You can also use Adobe Reader to view PDF files on your smartphone.

Benefits

- Manage Word, Excel, PowerPoint, and OneNote files on your smartphone
- Improve productivity by taking important docs, spreadsheets, and presentations with you
- Work with PDF files

In this chapter

Synchronizing your Microsoft Office files	237
Word Mobile®	239
PowerPoint Mobile®	246
Excel Mobile®	247
OneNote Mobile	258
Adobe® Reader® LE	261

Synchronizing your Microsoft Office files

You can create and edit Microsoft Office files on your computer or on your smartphone and then synchronize the files so that changes you make show up on both your computer and your smartphone. How synchronization happens depends on two conditions:

Operating system: Do you use Windows XP or Windows Vista®?

Sync direction: Are you transferring files from your smartphone to your computer, or from your computer to your smartphone?

For information about installing desktop sync software and about synchronizing with your computer, see [Installing the desktop sync software](#).

Synchronizing files that are on your smartphone: Windows XP or Windows Vista

BEFORE YOU BEGIN Turn on the option to synchronize files (see [Changing which applications sync](#)).

To synchronize files that you capture on or copy to your smartphone, simply follow one of the procedures for synchronizing with your computer described in [Synchronizing with desktop sync software](#).

After you synchronize, you can view and edit the items on your computer see [Where are the changes I made to my file?](#).

Synchronizing files that are on your computer: Windows XP

1 Connect your smartphone to your computer with the **USB cable**.

NOTE Most ActiveSync desktop software options are available only when your smartphone is connected to your computer.

- 2 On your computer, double-click the **ActiveSync**®  icon in the taskbar in the lower-right corner of your computer screen to open the ActiveSync desktop software window.

TIP If the ActiveSync icon does not appear in the taskbar, click **Start > Programs > Microsoft ActiveSync** to open the ActiveSync window.

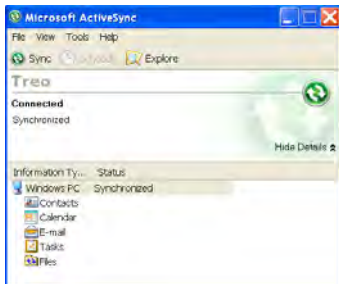

- 3 Under **Information Type**, double-click **Files** to view a list of all synchronized files.

TIP If Files doesn't appear under Information Type, open the **Tools** menu and select **Options**. Make sure the **Files** box is checked.

- 4 Do either of the following:
- To copy a file from your computer to your smartphone, click **Add**, browse to and highlight the file, and click **Open**.
 - To delete a file from the file sync folder on your computer and from your smartphone, highlight the file name and click **Remove**.

NOTE If you receive an error while synchronizing files, make sure that all of the files you're trying to sync are closed on both your computer and your smartphone.

TIP If a Treo My Documents sync folder has been created on your computer, you can also synchronize by dragging files into the appropriate subfolder under that folder.

Synchronizing files that are on your computer: Windows Vista

- 1 On your computer, copy or save the file to the Documents\Documents on *username*'s Smartphone folder.

DID YOU KNOW? The Documents on *username*'s Smartphone folder is created when you select the option to sync Files.

- 2 Connect your smartphone to your computer with the USB cable. Synchronization takes place automatically.

Where are the changes I made to my file?

Don't look for the changed file in its original location on your computer. Only the synchronized version contains the changes, and that version is in the file sync folder. To find this folder, do one of the following:







Windows XP: On your computer desktop, double-click the file sync folder icon. This is a shortcut to the file sync folder.

Windows XP: In ActiveSync desktop software, double-click **Files**. The location of the file sync folder appears in the File

Synchronization Settings dialog box (under On this computer, synchronize the files in this folder).

Windows Vista: Open the Documents\Documents on *username*'s Smartphone folder.

On your smartphone, you can find the synchronized file by doing either of the following:

- Press **Start**  and select **Office Mobile**. Select the application that opens the file: Word Mobile , Excel Mobile , PowerPoint Mobile , or OneNote Mobile .
- Press **Start** , select **Programs**, and then select **File Explorer** . Tap the **Show** list in the upper-left and select **My Device > My Documents**.

Word Mobile®

With Microsoft Office Word Mobile®, you can create and edit documents and templates and save them as DOC, RTF, TXT, and DOT files. You can also edit

Microsoft Office Word documents and templates that you create on your computer. However, keep in mind that some of the information and formatting may be lost when you save the document on your smartphone.

DID YOU KNOW? If you have a PDF file (.pdf), you can view the file using Adobe Reader. Press **Start**, select **Programs**, and then select **Adobe Reader** (see [Adobe® Reader® LE](#)).

The following features are not supported in Word Mobile:

- Backgrounds.
- Bidirectional text.
- Document protection.
- Metafiles.
- Artistic page borders. Lined page borders are supported.
- Password-protected files. Remove password protection on your computer before opening the file on your smartphone.
- Shapes and text boxes.
- Smart tags.

The following features are partially supported in Word Mobile:

Picture bullets: Regular bullets are supported.

Revision marks: Documents appear as though all revisions were accepted; if the document is saved, revision marks are lost.

Table styles: Some or all of the formatting is lost if the document is saved.

Underline styles: Unsupported styles are mapped to one of the four supported styles: regular, dotted, wavy, or thick/bold/wide.

Legacy Pocket Word files: You can open PSW files, but if you edit a file, you need to save it in DOC, RTF, TXT, or DOT format.

The following features are not supported on your smartphone, but they remain in the file so that when you open the file on your computer, they appear as expected:



Fonts and font sizes: Original fonts are listed on your smartphone and are mapped to the closest font available.

Footnotes, endnotes, headers, and footers.



Lists: Indented lists are mapped to the closest indentation level supported by Word Mobile.

Page breaks: Although not displayed, all page breaks, except a break placed at the end of a document, are retained in the document.

Creating a document

- 1 Press **Start**  and select **Office Mobile**.
- 2 Select **Word Mobile** .
- 3 The first time you open Word Mobile, a new document opens. Otherwise, press **New** (left softkey).
- 4 Enter the text of the document.
- 5 Press **OK**  to save the file. When you save a new document, it is automatically named after the first several words in the file.

Opening an existing document

- 1 Press **Start**  and select **Office Mobile**.
- 2 Select **Word Mobile** .

- 3 In the document list, select the document you want to open.

TIP To zoom in or out, press **View** (left softkey), select **Zoom**, and then select the zoom level.

Creating a document from a template

- 1 Go to the documents list.
- 2 Tap the **Show** list in the upper-left and select **Templates**. If you don't see Templates in the Show list, select **More Folders** to access this folder.
- 3 Open the template you want to use.
- 4 Press **Menu** (right softkey) and select **File > Save As**.
- 5 Select **Name** and enter a new name for the file.
- 6 Select the **Folder** list, and then select the folder where you want to save the file.
- 7 Select the **Type** list, and then select the format in which you want to save the file.
- 8 Select the **Location** list, and then select whether you want to store the file on your smartphone (**Main memory**) or on

an expansion card (**Storage card**). The Storage card option appears only if you have an expansion card (sold separately) inserted into your smartphone.

- 9 Select **Save**.

TIP To create a new template, open the document you want to save as a template. Press **Menu** (right softkey) and select **File > Rename/Move**. Select **Name** and enter a name for the template. Select **Folder**, and then select **Templates**. Press **OK**.

Finding or replacing text in a document

- 1 Open the document containing the text you want to find.
- 2 Press **Menu** (right softkey) and select **Edit > Find/Replace**.
- 3 Select **Find what** and enter the text you want to find.
- 4 (Optional) Check the **Match case** box to find text that matches the capitalization in the text you entered step 3.
- 5 (Optional) Check the **Match whole words only** box to find only full words that match the text you entered in step 3.

- 6 Select **Find** to locate the first instance of the text you entered in step 3, or select **Replace** and enter the replacement text.
- 7 Select **Next** to find the next instance of the text, or select **Replace** to replace it. To replace all instances of the text, select **Replace All**.
- 8 When you see a message that the search is done, press **OK** .

Moving or copying text

- 1 Open the document containing the text you want to move or copy.
- 2 Highlight the text you want to move or copy.
- 3 Press **Menu** (right softkey) and select **Copy** to copy the text, or select **Cut** to move the text.
- 4 Open the document where you want to insert the text and position the cursor where you want the text to appear.
- 5 Press **Menu** (right softkey) and select **Paste**.

Saving a copy of a document

NOTE If a document was previously saved on a computer, any unsupported formatting may be lost when you save the file.

- 1 Open the document you want to copy.
- 2 Press **Menu** (right softkey) and select **File > Save As**.
- 3 Select **Name** and enter a new name for the file.
- 4 Select the **Folder** list, and then select the folder where you want to save the file.
- 5 Select the **Type** list, and then select the format in which you want to save the file.
- 6 Select the **Location** list, and then select whether you want to store the file on your smartphone (**Main memory**) or on an expansion card (**Storage card**). The Storage card option appears only if you have an expansion card (sold separately) inserted into your smartphone.
- 7 Select **Save**.

Formatting text

- 1 Open the document you want to format.
- 2 Highlight the text you want to format.
- 3 Press **Menu** (right softkey) and select **Format > Font**.
- 4 Set any of the following options for the highlighted text:

Font: Specifies the typeface.

Font color: Specifies the color.

Size: Specifies the point size.

Bold: Indicates whether the text appears normal or thick.

Italic: Indicates whether the text appears upright or slanted.

Underline: Indicates whether the text appears with an underscore.

Highlight: Indicates whether the text appears with a yellow highlight.

Strikethrough: Indicates whether the text appears with a line through it.

- 5 Press **OK**  to return to the document.

Formatting paragraphs and lists

- 1 Open the document you want to format.
- 2 Position the cursor in the paragraph you want to format.
- 3 Press **Menu** (right softkey) and select **Format > Paragraph**.
- 4 Set any of the following options:

Alignment: Aligns the text paragraph with the left, right, or center of the page.

List: Creates a bulleted or numbered list.

Indentation: Changes the paragraph margins.

- **Left:** Sets the left margin for the entire paragraph.
 - **Right:** Sets the right margin for the entire paragraph.
 - **Special:** Lets you indent the first line or set a hanging indent.
 - **By:** Sets the size of the special indentation.
- 5 Press **OK**  to return to the document.

TIP You can also use the Formatting toolbar to create a list and to align text. To indent text in lists, you must use the Formatting toolbar.

Checking spelling in a document

- 1 Open the document you want to check.
- 2 Press **Menu** (right softkey) and select **Tools > Spelling**. To check the spelling of specific text, highlight it before you select Spelling.
- 3 If an unknown or misspelled word is encountered, do one of the following:
 - Select the correct word in the list if the word is spelled incorrectly.
 - Select **Ignore** if the word is spelled correctly. Select **Ignore All** to skip all instances of the word.
 - Select **Add** to add a new word to the spelling dictionary.

Organizing your documents

You can rename your documents, move your documents to another folder, and move your documents between your smartphone and an expansion card (sold separately) inserted into your smartphone.

- 1 Go to the documents list.
- 2 Highlight a file.
- 3 Press **Menu** (right softkey) and select **Rename/Move**.
- 4 Select **Name** and enter a new name for the document.
- 5 Select the **Folder** list, and then select the folder to which you want to move the document.
- 6 Select the **Location** list, and then select whether you want to store the file on your smartphone (**Main memory**) or on an expansion card (**Storage card**). The Storage card option appears only if you have an expansion card (sold separately) inserted into your smartphone.
- 7 Press **OK** .

TIP To create a new folder, go to the documents list, tap the **Show** list in the upper-left and select **Add/Delete**. Select **New**, enter a name for the folder, and press **OK**.

TIP When you go to a folder, you can easily search your documents by sorting by type.

Deleting a document

- 1 Go to the documents list.
- 2 Highlight the document you want to delete.
- 3 Press **Menu** (right softkey) and select **Delete**.
- 4 Select **Yes** to confirm the deletion.

Customizing Word Mobile

- 1 Go to the document list.
- 2 Press **Menu** (right softkey) and select **Options**.
- 3 Set any of the following options:

Default template: Sets the default template for new documents.

Save to: Sets the default location where new documents are stored.

Display in list view: Sets the types of files that appear in the documents list.



- 4 Press **OK** .

PowerPoint Mobile®

With Microsoft Office PowerPoint Mobile®, you can open and view slide show presentations created on your computer. Many presentation elements such as slide transitions, animations, and URL links are also supported. Microsoft Office PowerPoint features not supported on your smartphone include the following:

- Notes written for slides
- Rearrangement or editing of slides
- Files created in PPT format earlier than Microsoft PowerPoint 97
- HTML files in HTM and MHT formats



Playing a presentation

- 1 Press **Start**  and select **Office Mobile**.
- 2 Select **PowerPoint Mobile** .
- 3 In the presentation list, select the presentation you want to play.

4 Do any of the following:

- Press **Right**  to advance to the next slide or **Left**  to view the previous slide.

NOTE If a presentation is set up as a timed slide show, the slides advance automatically. Presentations pause during zooming.

- Press **Center** , select **Go to Slide**, and then select the slide you want to view.
- Press **Center**  and select **Next** or **Previous** to play animations.
- To zoom in, press **Center**  and select **Zoom In**. Tap and drag the slide to scroll it.

5 To end the slide show, press **Center**  and select **End Show**.

Setting presentation playback options

- 1 Highlight the presentation for which you want to change the settings.
- 2 Press **Menu** (right softkey) and select **Set up show**.
- 3 On the Orientation tab, select the orientation you want. To select the

orientation that best fits your smartphone screen, select **Default**.

- 4 Select the **Playback** tab, and check the **Override playback options for all files** box.
- 5 Set any of the following options:
 - Show without animation:** Turns off builds and other animations.
 - Show without slide transition:** Turns off transition effects between slides.
 - Use timings, if present:** Enables the timings recorded with each slide in a presentation. If a presentation is set up as a timed slide show, the slides advance automatically. Presentations pause during zooming.
 - Loop continuously:** Advances to the first slide after playing the last slide in a presentation.
- 6 Press **OK** .

TIP To turn the presentation into a continuously looping slide show, check both the **Use timings, if present** and the **Loop continuously** boxes.

Excel Mobile®

With Microsoft Office Excel Mobile®, you can create and edit workbooks and templates on your smartphone. You can also edit workbooks and templates that you create on your computer. However, you may lose some of the information and formatting when you save the workbook on your smartphone.

Note the following formatting considerations:

Alignment: Vertical text appears horizontal.

Borders: Appear as a single line.

Cell patterns: Patterns applied to cells are removed.

Fonts and font sizes: The original font is listed on your smartphone and mapped to the closest font available. Original fonts reappear on your computer.

Number formats: Microsoft Office Excel 97 conditional formatting is displayed in Number format.

Formulas and functions: Unsupported functions are removed, and only the returned value of the function appears. Formulas containing the following are also converted to values:

- An array or array argument, for example, =SUM({1;2;3;4}).
- External link references or an intersection range reference.
- References past row 16384 are replaced with #REF!.

Protection settings: Most protection features are disabled but not removed. However, password protection is removed. You must remove the password protection in Microsoft Office Excel on your computer before opening the file on your smartphone.

Zoom settings: Worksheet-specific zoom settings are not retained. The zoom setting applies to the entire workbook.

Worksheet names: Names that refer to other workbooks, arrays, array formulas, or intersection ranges are removed from the name list, causing those formulas to be resolved as “#NAME?” All hidden names are not hidden.





AutoFilter Settings: AutoFilters that cause rows to be hidden are supported. Use the Unhide command to display hidden rows. Other AutoFilters are removed, but you can use the AutoFilter command in Excel Mobile to perform similar functions.

Chart Formatting: All charts are saved as they appear in Excel Mobile. Unsupported chart types are changed to one of these supported types: Column, Bar, Line, Pie, Scatter, and Area. Background colors, gridlines, data labels, trend lines, shadows, 3D effects, secondary axes, and logarithmic scales are turned off.

The following features aren't supported in Excel Mobile and are removed or modified when you open a workbook on your smartphone:

- Hidden, dialog, and macro sheets
- VBA modules
- Text boxes
- Drawing objects and pictures
- Lists
- Conditional formats and controls
- Pivot table data (converted to values)

Creating a workbook

- 1 Press **Start**  and select **Office Mobile**.
- 2 Select **Excel Mobile** .
- 3 The first time you open Excel Mobile, a new workbook appears. Otherwise, press **New** (left softkey).
- 4 Highlight a cell where you want to enter text or other info.
- 5 Enter the info in the cell and press **Return** .
- 6 Repeat steps 4 and 5 to enter the remaining info.
- 7 Press **OK**  to save the file. When you save a new workbook, it is automatically named and placed in the workbook list.



Creating a workbook from a template

- 1 Go to the workbook list.
- 2 Tap the **Show** list in the upper-left and select **Templates**. If you don't see Templates in the Show list, select **More Folders** to access this folder.
- 3 Open the template you want to use.

- 4 Press **Menu** (right softkey) and select **File > Save As**.
- 5 Select **Name** and enter a new name for the workbook.
- 6 Select the **Folder** list, and then select the folder where you want to save the workbook.
- 7 Select the **Type** list, and then select the format in which you want to save the workbook.
- 8 Select **Save**.

TIP To create a new template, highlight the workbook you want to save as a template. Press **Menu** (right softkey), select **Rename/Move**, select **Name**, and then enter a name for the template. Select the **Folder** list, and then select **Templates**. Press **OK**.

Viewing a workbook

- 1 Press **Start**  and select **Office Mobile**.
- 2 Select **Excel Mobile** .
- 3 In the workbook list, select the workbook you want to view.

- 4 Press **View** (left softkey) and select any of the following:

Full Screen: Shows as much data as possible on the screen. To return to the normal view, tap **Restore** in the upper-right.

Zoom: Sets the magnification level so that you can easily read the worksheet.

Sheet: Lets you switch to a different worksheet.

DID YOU KNOW? You can also switch worksheets by tapping the sheet list at the bottom of the screen.

Split: Divides the window into two scrollable areas. To move the split bar, tap and drag it. To remove the split bar, press **View** (left softkey) and select **Remove Split**.

Freeze Panes: Locks rows and columns so they remain visible while you scroll. Highlight the cell at the point at which you want to lock before you select this command. To unlock the rows or columns, press **View** (left softkey) and select **Unfreeze Panes**.



Toolbar: Indicates whether the toolbar appears onscreen.

Status Bar: Indicates whether the status bar appears onscreen.

Show: Indicates whether headings and scroll bars appear onscreen.

TIP To jump to a cell or region, press **Menu** and select **Edit > Go To**. Select **Cell reference or name** and enter the target cell info, or select **Current region**. Select **OK**.

Calculating a sum

- 1 Press **View** (left softkey) and select **Toolbar**.
- 2 Highlight the cell where you want to insert the sum.
- 3 Tap .
- 4 Tap and drag the stylus across the cells you want to add.
- 5 Press **Return** .

TIP For simple calculations, use the Calculator (see [Calculator](#)).

Entering a formula

- 1 Highlight the cell where you want to enter the formula.
- 2 Enter an equals sign (=) followed by any values, cell references, name references, operators, and functions.

Examples:

- =(B4/25)+100
- =Revenue-Expenses

- 3 Press **Return** .

TIP Use the Alt key to insert an equal sign.

TIP To insert a symbol, place the cursor where you want the symbol. Press **Menu** (right softkey) and select **Insert > Symbol**. Highlight the symbol you want to insert, and select **Insert**.

Referring to a cell or range in a formula

- 1 Open the workbook where you want to refer to a cell or range in a formula.
- 2 Begin entering a formula in a cell.
- 3 Navigate to the cell you want to refer to in the formula. To refer to a range, tap and drag the stylus over the cells you want to include in the range.

- 4 Finish entering the formula and press **OK** .

TIP To refer to a cell from another worksheet in your formula, enter the worksheet name followed by an exclamation point (!) and the cell, range, or name reference.
Example: =Sheet1!Earnings

TIP To create a 3-D reference in your formula, specify two or more sheets in a workbook. Use a colon between the first and last worksheet names.
Example: =SUM(Sheet2:Sheet6!\$A\$2:\$C\$5)

Inserting a function

- 1 Open the workbook where you want to insert the function.
- 2 Press **Menu** (right softkey) and select **Insert > Function**.

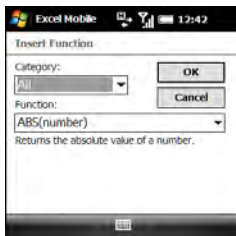

- 3 Select the **Category** list, and then select the type of function you want to insert.
- 4 Select the **Function** list, and then select the specific function you want to insert.
- 5 Select **OK**.

Entering a sequence automatically

- 1 Tap and drag with the stylus to highlight both the cells containing the info you want to automate and the adjacent destination cells.
- 2 Press **Menu** (right softkey) and select **Edit > Fill**.
- 3 Select the **Direction** list, and then select the direction you want to populate.
- 4 Select the **Fill type** list, and then select **Series**.
- 5 Select the **Series type** list, and then select the type of series you want. If you select **Date** or **Number**, enter a **Step value** increment.

TIP Select **Autofill** as the series type to quickly fill cells with repetitive data such as numbers or repeated text. Autofill takes the content of the first cell in the highlighted row or column and copies it down or across the rest of the selection.

- 6 Select **OK**.

Adding cells, rows, and columns

- 1 Open the workbook you want.
- 2 Highlight the area where you want to insert elements.
- 3 Press **Menu** (right softkey) and select **Insert > Cells**.
- 4 Select how you want to insert the elements:

Shift cells right: Inserts the same number of new cells as the number of cells you highlighted horizontally in step 2. For example, if you selected an area containing two cells horizontally (A1 and B1), selecting Shift cells right inserts two horizontal cells; so the original A1 and B1 (and their contents) are now C1 and D1. The highlighted area and all cells on the right move the same

number of columns—two in this example—to the right.

Shift cells down: Inserts the same number of new cells as the number of cells you highlighted vertically in step 2. For example, if you selected an area containing two cells vertically (A1 and A2), selecting Shift cells down inserts two vertical cells; so the original A1 and A2 (and their contents) are now A3 and A4. The highlighted area and all cells below it move the same number of rows—two in this example—down.

Entire row: Inserts the same number of new rows as the number of cells you highlighted vertically in step 2. For example, if you selected an area containing two cells vertically (A1 and A2), selecting Entire row inserts two rows; so the original rows 1 and 2 (and their contents) are now rows 3 and 4. The rows containing the highlighted area and all rows beneath it move the same number of rows—two in this example—down.

Entire column: Inserts the same number of new columns as the number

of cells you highlighted horizontally in step 2. For example, if you selected an area containing two cells horizontally (A1 and B1), selecting Entire column inserts two columns; so the original columns A and B (and their contents) are now columns C and D. The columns containing the highlighted area and all columns on the right move the same number of columns—two in this example—to the right.

5 Select **OK**.

TIP To add a new worksheet, press **Menu** and select **Format > Modify Sheets**. Select **Insert**, enter a name for the worksheet, and press **OK**. To change the order of the worksheets, highlight a worksheet you want to move, select **Move Up** or **Move Down**, and press **OK**.

Formatting cells

- 1 Open the workbook you want to format.
- 2 Highlight the cells you want to format.
- 3 Press **Menu** (right softkey) and select **Format > Cells**.

- 4 Select any of the following tabs:

Size: Sets the row height and column width.

Number: Sets the type of information the cells contain.

Align: Sets whether text wraps within the highlighted cells, and sets horizontal and vertical alignment position.

Font: Sets the typeface, color, size, and style attributes.

Borders: Turns borders on and off for various cell edges, and sets the border and background colors.

- 5 Press **OK** .

TIP To name the highlighted cell or range of cells, press **Menu** and select **Insert > Define Name**. Enter the name and select **Add**. Press **OK**.

Formatting rows and columns

- 1 Open the workbook you want to format.
- 2 Highlight the rows or columns you want to format.

- 3 Press **Menu** (right softkey) and select **Format > Row** or **Format > Column**.

- 4 Select any of the following:

AutoFit: Adjusts the size of the highlighted rows or columns to their contents.

Hide: Hides the highlighted rows or columns.

Unhide: Displays hidden rows or columns in the highlighted area.

DID YOU KNOW? You can adjust the column and row size by tapping and dragging the right edge of the column or the bottom edge of the row. To automatically fit rows and columns to their contents, double-tap the lower edge of the row heading or the right edge of the column heading.

Renaming a worksheet

- 1 Open the workbook containing the worksheet you want to rename.
- 2 Press **Menu** (right softkey) and select **Format > Modify Sheets**.
- 3 In the Sheets list, highlight the worksheet you want to rename.

- 4 Select **Rename**, enter a new name for the worksheet, and press **OK**  twice.

Sorting info in a worksheet

- 1 Highlight the cells you want to sort.
- 2 Press **Menu** (right softkey) and select **Tools > Sort**.
- 3 Select the **Sort by** list, and then select the primary sort column.
- 4 Check the **Ascending** box to sort in ascending (A–Z or 0–9) order. Leave the box unchecked to sort in descending (Z–A or 9–0) order.
- 5 (Optional) Select the **Then by** lists, and then select second- and third-level sorting options.
- 6 Check or uncheck the **Exclude header row from** sort box to indicate whether you want to sort the header row.
- 7 Select **OK**.

Filtering info in a worksheet

- 1 Tap and drag the stylus to highlight the cells that contain the info you want to filter.

- 2 Press **Menu** (right softkey) and select **Tools > AutoFilter**. In each column containing a highlighted cell, an arrow appears on the right side of the cell nearest the top of the column.
- 3 Tap the arrow to open a list and select a filter. This hides all rows that do not include the selected filter.
- 4 (Optional) Do any of the following:
 - Open the other lists, and select other filters.
 - To display all rows again, open the filter lists and select **All**.
 - To turn off filtering, press **Menu** (right softkey) and select **Tools > AutoFilter** again.

DID YOU KNOW? You can also create custom filters where you specify comparisons. Open a filter list and select **Custom**.

Creating a chart

- 1 Open the workbook in which you want to create a chart.
- 2 Highlight the cells you want to include in the chart.

- 3 Press **Menu** (right softkey) and select **Insert > Chart**.
- 4 Select the type of chart, and press **Next** (right softkey).
- 5 Confirm the area you want the chart to include, and press **Next** (right softkey).
- 6 Select the data layout, and press **Next** (right softkey).
- 7 Check the boxes to indicate whether the first row and column represent labels.
- 8 Select whether you want the chart to appear as a separate worksheet within the current workbook, or as part of the current worksheet.
- 9 Press **Finish** (right softkey).

Formatting or changing a chart

- 1 Open the workbook that contains the chart you want to format.
- 2 Open the chart.
- 3 Press **Menu** (right softkey) and select **Format > Chart**.
- 4 Select any of the following tabs:
Titles: Specifies the title of the chart and headings, whether a legend

appears, and the placement of the legend.

Scale: Specifies the minimum and maximum scales for charts with x and y axes.



Type: Specifies the chart style. You can use this setting to convert your chart to a different format.

Series: Lets you add, modify, format, or delete related data points without affecting the info in your worksheet.

- 5 Press **OK** .

Finding or replacing info in a workbook

- 1 Open the workbook containing the info you want to find.
- 2 Press **Menu** (right softkey) and select **Edit > Find/Replace**.
- 3 Select **Find what** and enter the info you want to find.
- 4 (Optional) Check the **Match case** box to find text that matches the capitalization in any text you entered.
- 5 (Optional) Check the **Match entire cells** box to find only cells whose contents exactly match the text you entered.

- 6 Select **Find** to locate the first instance of the info you entered, or select **Replace** and enter the replacement info.
 - 7 Select **Next** to find the next instance of the info, or select **Replace** to replace it. To replace all instances of the info, select **Replace All**.
 - 8 When you see a message that the search is done, press **OK** .
- 6 Select the **Location** list, and then select whether you want to store the file on your smartphone (**Main memory**) or on an expansion card (**Storage Card**). The Storage Card option appears only if you have an expansion card (sold separately) inserted into your smartphone.
 - 7 Press **OK** .

TIP When you go to a folder, you can easily search your files by sorting by type.

Organizing your workbooks

You can rename your workbooks. You can also move them to another folder or move them between your smartphone and an expansion card (sold separately) inserted into your smartphone.

- 1 Go to the workbook list.
- 2 Highlight a file.
- 3 Press **Menu** (right softkey) and select **Rename/Move**.
- 4 Select **Name** and enter a new name for the workbook.
- 5 Select the **Folder** list, and then select the folder to which you want to move the workbook.

Deleting cells, rows, and columns

- 1 Open the workbook containing the elements you want to delete.
- 2 Highlight the area you want to delete.
- 3 Press **Menu** (right softkey) and select **Edit > Delete Cells**.
- 4 Select how you want to remove the elements:
 - Shift cells left:** Deletes the highlighted cells and moves all cells on their right to the left.
 - Shift cells up:** Deletes the highlighted cells and moves all cells below them up.

Entire row: Deletes the entire row(s) in which the highlighted cells are located, and moves all rows below up.

Entire column: Deletes the entire column(s) in which the highlighted cells are located, and moves all columns on their right to the left.

NOTE Excel Mobile adjusts formulas to reflect the new cell locations. However, a formula that refers to a deleted cell displays the #REF! error value.

5 Select **OK**.

TIP To delete a workbook, go to the workbook list and highlight the workbook you want to delete. Press **Menu** (right softkey) and select **Delete**. Select **Yes** to confirm.

TIP To delete a worksheet, press **Menu** (right softkey) and select **Format > Modify Sheets**. Highlight the worksheet you want to delete and select **Delete**. Select **Yes** and press **OK**.

Customizing Excel Mobile

- 1 Go to the workbook list.
- 2 Press **Menu** (right softkey) and select **Options**.

- 3 Set any of the following options:

Template for new workbook:

Specifies the default template for new workbooks.

Save new workbooks to: Specifies where new workbooks are stored.

Files to display in list view: Specifies which types of files appear in the workbook list.



- 4 Press **OK** .

OneNote Mobile

OneNote Mobile lets you create digital notes that contain text, pictures, and audio and video. You can then synchronize these notes with Microsoft Office OneNote 2007 on your computer. During synchronization, all the notes you create on your smartphone are copied to a notebook called OneNote Mobile on your computer; you can then drag your notes to other locations on your computer. You can use OneNote Mobile to do any of the following:

- Take pictures of business cards and then insert them into OneNote.
- Take pictures of flip charts and whiteboards in conference rooms, and then insert them into OneNote.
- Create text notes and voice recordings (for example, reminders of important events, ideas for projects, price comparisons, recommendations, blog ideas, and so on) and synchronize them with your notes.
- Prepare meeting or travel information in OneNote on your computer and then transfer it to your smartphone so you can access the information on the road.

Creating a note

- 1 Press **Start**  and select **Office Mobile**.
- 2 Select **OneNote Mobile** .
- 3 Press **New** (left softkey).
- 4 Begin typing your note text, or do any of the following:

Format text: Press **Menu** (right softkey), select **Format**, and then select the formatting option you want: **Bold**,

Italic, **Underline**, or **Strikethrough**.

Enter the text you want formatted.

To resume entering unformatted text, press **Menu** (right softkey), select **Format**, and then select the formatting option again.

TIP You can apply more than one formatting style to text. Press **Menu** (right softkey) and select **Format** for each style you want to apply to the text you are going to enter.

TIP To clear the formatting from entered text, highlight the text with the stylus, press **Menu** (right softkey), and select **Format > Clear All**.

Enter a list: Press **Menu** (right softkey), select **List**, and then select **Numbered** or **Bulleted**. When you have finished entering the list items, press **Menu** (right softkey), select **List**, and then select the list option again to turn off list formatting.

TIP To remove list formatting from entered text, highlight the text with the stylus, press **Menu** (right softkey), and select **List > Clear**.

Create a hyperlink: Enter the website address for which you want to create the hyperlink. For example, to create a hyperlink to the Microsoft website, enter **http://www.microsoft.com**.



Insert a picture: Press **Menu** (right softkey) and select **Take Picture** to take a picture with your smartphone's camera or **Insert Picture** to insert an existing picture.

Insert an audio recording: Press **Menu** (right softkey) and select **Insert Recording**. Tap the onscreen controls to create your recording. Tap **OK** to accept the recording and add it to the note.

- 5 When you have finished creating your note, press **Done** (left softkey).

TIP While you are composing the note, use menu items to undo and redo your last action, and to cut, copy, and paste text. After you have completed the note and pressed Done, use menu commands to delete or rename the note.

Viewing or editing an existing note

- 1 Press **Start**  and select **Office Mobile**.
- 2 Select **OneNote Mobile** .
- 3 In the OneNote Mobile list, select the note that you want to open.
- 4 Do any of the following:

Open a hyperlink: Place the cursor anywhere in the link, and then press **Center** .

View picture detail: Highlight the picture, press **Center** , and then press **Menu** (right softkey) and select **Zoom In**. To zoom in further, press **Menu** (right softkey) and select **Zoom In** again. Use the **5-way** to view different parts of the picture. To zoom out, press **Menu** (right softkey) and select **Zoom Out**; you can also select **Actual Size** or **Fit to Screen**.



Play a voice note: Highlight the voice note and press **Center** .

- 5 Press **Done** (left softkey) to close the note.

Renaming a note

- 1 In the OneNote Mobile list, select the note that you want to rename.
- 2 Press **Menu** (right softkey), and then select **Rename**.
- 3 Enter the new name.
- 4 Press **Done** (left softkey) to accept the new name.

Sorting your notes

- 1 Press **Start**  and select **Office Mobile**.
- 2 Select **OneNote Mobile** .
- 3 Press **Menu** (right softkey) and select **Options**.
- 4 In the Sort notes by list, press **Up** ▲ or **Down** ▼ to select **Name** or **Date modified**.
- 5 Press **Done** (left softkey).

Deleting a note

- 1 In the OneNote Mobile list, select the note that you want to delete.

- 2 Press **Menu** (right softkey), and then select **Delete**.
- 3 Select **Yes** to confirm deletion.

Adobe® Reader® LE

Adobe® Reader® LE lets you view PDF files whether they are saved to your smartphone, attached to email messages, stored on an expansion card (sold separately) inserted into your smartphone's expansion card slot, or downloaded from the web. You can customize the document display.

Viewing a file

Adobe Reader LE supports password-protected PDF files with up to 128-bit encryption. When you open a password-protected PDF file, you must enter the password to open the file.

- 1 Press **Start**  and select **Programs**.
- 2 Select **Adobe Reader** .

- 3 Navigate to and select the file you want to open.

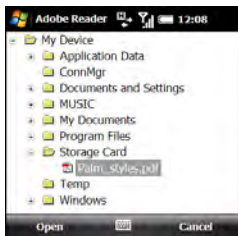

TIP To open additional files, press **Menu** (right softkey) and select **Open**. Select the file you want from the list, or select **Browse** to navigate to and select the file.

- 4 Press **Down** ▼ to scroll to the next page (in Single Page mode) or scroll the continuous display down (in Continuous mode). Press **Up** ▲ to scroll to the preceding page or scroll the continuous display up.

- 5 Tap any of the following to move around within the PDF file:

- ▶ Move to the next page.
- ◀ Move to the previous page.
- ◀▶ Jump to the first page of the file.
- ▶ Jump to the last page of the file.

- 6 To open another file, press **Menu** (right softkey) and select **Open**. Select a recently opened file, or select **Browse** and navigate to the file you want.



TIP To go to a specific page, press **Tools** (left softkey) and select **Go To**.

DID YOU KNOW? If the file was created with bookmarks, Adobe Reader LE displays the bookmarks pane on the left side of the screen. Select a heading in the bookmarks pane to jump to that section.

DID YOU KNOW? To view detailed information about the file you are viewing, press **Menu** (right softkey) and select **Details**.

Changing display options

You can change the display size, the scroll option, and more.

- 1 Press **Tools** (left softkey), select **View**, and then select any of the following:

Rotate Right/Left: Rotates the page in the selected direction.

Single Page: Displays the pages so that when you use Up ▲ or Down ▼ to scroll the file, the display jumps a page at a time

Continuous: Displays the pages so that when you use Up ▲ or Down ▼ to scroll the file, the display scrolls continuously up or down without jumping.

- 2 Press **Tools** (left softkey), select **Zoom**, and then select one of the following options:

In: Increases the file display size to enlarge font and image size

Out: Decreases the file display size to fit more of the file on the screen

To %: Specifies a specific zoom level for the display

Fit screen: Sizes the display so an entire page fits on the screen top to bottom

Fit width: Sizes the display so that the width of the page fills the display from side to side

Finding text in a file

- 1 With the file open, press **Tools** (left softkey) and select **Find > Text**.
- 2 Select **Find** and enter the text you want to find.
- 3 (Optional) Check the **Match case** box to find text that matches the capitalization in the text you entered.

- 4 (Optional) Check the **Whole word** box to find only full words that match the text you entered.
- 5 (Optional) Check the **Backwards** box to search the file backwards.
- 6 Press **Find** (left softkey).
- 7 To find the next occurrence of the text, press **Tools** (left softkey) and select **Find > Next**.



Your application and info management tools

Your Palm® Treo™ Pro smartphone comes equipped with a variety of tools for managing and organizing your information. Find nearby businesses and driving directions. Get the most out of your smartphone: Install some of the thousands of business, education, or leisure-time applications available. Use one of several options to share business and personal info with others. Insert expansion cards (sold separately) for a compact and virtually limitless answer to the storage dilemma. And because there's one on your smartphone, you never need to carry a separate calculator.

Benefits

- Locate info in any application, or locate any address on a map
- Install applications, games, and other software
- Keep others up-to-date with meaningful business and personal information
- Store, carry, and exchange info
- Always have a calculator with you

In this chapter

Finding information	267
Installing applications	269
Removing applications	272
Sharing information	273
Beaming information	274
Using expansion cards	276
Accessing information on a remote computer	281
Calculator	282

Finding information

Quickly find who or what you're looking for by using one of these search features:

Search: Look through the text in all the applications on your smartphone.

File Explorer: Browse through the files and folders on your smartphone or on an expansion card.

Lookup: Find and dial your contacts by name or phone number. See [Dialing by contact name](#) for details.

Global Address List Lookup: Look up names in your online corporate address list (see [Finding a contact in an online address book](#)).

Email message search: Display only those messages whose senders, recipients, or subjects match the text you enter (see [Finding messages](#)).

QuickGPS: Get driving directions to any location (see [Determining your GPS location](#)).

TIP For information on opening and closing apps, see [Opening and closing applications](#)

Using Search

Search for files and other items stored in the My Documents folder on your smartphone or on an expansion card (sold separately) inserted into your smartphone. You can search by file name or by words located in the item. For example, you can search for words within notes, appointments, contacts, and tasks.

DID YOU KNOW? Contacts on your SIM card do not appear in the search results list.

- 1 Press **Start**  and select **Programs**.
- 2 Select **Search** .

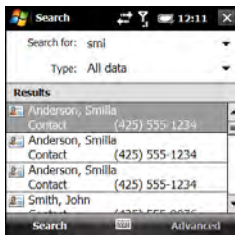

DID YOU KNOW? You can also open Search by pressing **Option + left Shift**.

- 3 Select **Search for** and enter the file name, word, or other info you want to find.

TIP If you've looked for an item before, select the **Search for** list, and then select the item in the list.

TIP When two or more words are entered in the Search for field, the search results contains only items that contain all of the words.

- 4 Select the **Type** list, and then select the kind of information you want to find.

TIP If you are searching for information in certain applications, such as Messaging or Word Mobile, press **Advanced** (right softkey) for more search options.

- 5 Press **Search** (left softkey).

- 6 Use the 5-way to select and view an item from the results of the search. A storage card symbol appears next to the names of files that are located on an expansion card.

Exploring files and folders

You can use File Explorer to browse the contents of folders on your smartphone or on an expansion card (sold separately) inserted into your smartphone. The root folder on your smartphone is named My Device. My Device is similar to My Computer (Windows XP) or Computer (Windows Vista) on your computer.

- 1 Press **Start**  and select **Programs**.

- 2 Select **File Explorer** .

- 3 Select the folder you want to explore. If the folder you want is not displayed, tap the **Show** list in the upper-left and select **My Device** to view all folders.

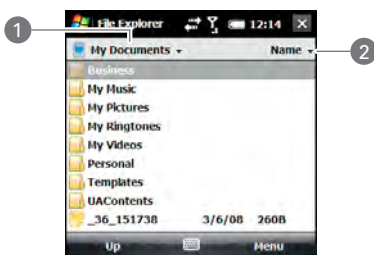

- 1 Show list
- 2 Sort by list

TIP When the items in a folder are displayed, you can sort them by name, date, size, or type. Select the **Sort by** list in the upper-right, and then select the sort method.

DID YOU KNOW? The storage card symbol appears next to the names of files that are stored on an expansion card.



- 4 Do any of the following:

To open an item: Select it.

To quickly delete, rename, beam, or email an item: Highlight the item, press and hold **Center**  to open the shortcut menu, and then select the appropriate command.

IMPORTANT Do not delete any files that you cannot identify. These files may be required for your smartphone to function properly.

To move a file to another folder:

Highlight the item, press and hold **Center**  to open the shortcut menu, and select **Cut** or **Copy**. Open the destination folder, press and hold **Center**  to open the shortcut menu, and then select **Paste**.

To highlight multiple items: Tap and drag the stylus.

Installing applications

Your smartphone comes with several built-in and ready-to-use applications. You can also install third-party applications that are compatible with Microsoft Windows Mobile® 6.1 Professional edition devices, such as business software, games, and more.

Applications you download to your computer are likely to be in a compressed

format such as ZIP. If the file is compressed, you need to decompress the file before you install the application on your smartphone. You can decompress the file on your smartphone in File Explorer or on your computer using a decompression utility such as WinZip.

TIP You can also send the file to yourself as an email attachment, and then open the attachment on your smartphone to automatically decompress the file (see [Opening attachments](#)).

The following instructions tell you how to install basic files onto your smartphone. Some software uses an installer or wizard to guide you through the process. For details, consult the documentation that came with the software.

TIP If an application does not have a Microsoft Mobile to Market certificate, you see a message indicating that the application is untrusted. If this occurs, you can indicate whether you want to continue the installation.

Installing third-party applications

When installing third-party applications, note the following:

- Install only apps that are designed for Microsoft Windows Mobile 6.1 Professional. Apps designed for other versions of Microsoft Windows Mobile may not be compatible with your smartphone.
- If you can try a free or trial version of the software before purchasing it, you can test it first to make sure it works properly.

NOTE If you encounter a problem with a third-party application (such as an error message), contact the application's vendor. For general troubleshooting of third-party applications, see [Third-party applications](#).





DID YOU KNOW? You can purchase a third-party application that lets you run Palm OS® by ACCESS applications on your smartphone.

Installing applications from the Internet

You can use Internet Explorer Mobile to install Windows Mobile apps in the CAB file format directly from the Internet. For

files in the ZIP file format, you must unzip the files in File Explorer or on your computer before you install them. For files in any format other than CAB or ZIP, you must first download the files to your computer and then install them to your smartphone by synchronizing.

BEFORE YOU BEGIN Make sure your phone is on and that you are in a coverage area (see [Turning your phone on](#)).

- 1 Press **Start**  and select **Internet Explorer**.
- 2 Go to the page that contains the link to the application you want to download.
- 3 Highlight the link to the file, and then press **Center**  to start the download process.
- 4 If prompted, select the folder where you want to store the file.
- 5 When the download has finished, press **Start**  and select **Programs**.
- 6 Select **File Explorer** .
- 7 Go to the folder you selected in step 4. If you did not select a folder, go to the **My Documents** folder.

- 8 Select the file you downloaded to start the installation program.

Installing applications from your computer

There are many applications available for your smartphone. To get started, check out the selection at palm.com/treoproumts-support.

BEFORE YOU BEGIN To install an application from your computer to your smartphone, you must first install the desktop sync software on your computer (see [Installing the desktop sync software](#)).

- 1 Connect your smartphone to your computer to synchronize and install the application(s) on your smartphone.
- 2 Open **My Computer** or **Windows Explorer** on your computer.
- 3 Double-click the icon representing your smartphone.
- 4 Copy the application file(s) into the folder.



Installing applications onto an expansion card

BEFORE YOU BEGIN To install an application from your computer to an expansion card, you must first install the desktop sync software on your computer (see [Installing the desktop sync software](#)).

- 1 Insert the expansion card (sold separately) into the expansion card slot (see [Inserting and removing expansion cards](#)).
- 2 Connect your smartphone to your computer using the USB cable.
- 3 Open **My Computer** or **Windows Explorer** on your computer.
- 4 Double-click the icon representing your smartphone.
- 5 Navigate to the folder representing the expansion card.
- 6 Copy the application file(s) into the expansion card folder.

Installing Java games and applications



You can install Java application files called Midlets onto your smartphone, either from your computer or from the Internet.

- 1 Press **Start**  and select **Programs**.
- 2 Select **Java** .
- 3 Press **Menu** (right softkey), select **Install**, and then select **Local** (to install a file from your computer) or **Internet**.

After you install the file, press **Menu** (right softkey) to perform various tasks using the file.

Removing applications

To free up memory on your smartphone, you can remove applications that you no longer use. You can remove only applications, patches, and extensions that you install; you cannot remove the built-in applications that reside in the Read-Only Memory (ROM) portion of your smartphone.

- 1 Press **Start**  and select **Settings**.
- 2 Select the **System** tab, and then select **Remove Programs** .



- 3 Select the application that you want to remove.

DID YOU KNOW? Built-in applications that cannot be deleted are not listed in the Remove Programs list.

- 4 Select **Remove**.
- 5 Select **Yes** to confirm the deletion.

Sharing information

Your smartphone comes equipped with a variety of options for sharing information, so that you can choose the quickest, most convenient way to send

your info or to receive info from another device.

- In many applications, you can send a file or an entry by email or beaming. Open the app to the file or entry list and highlight the item you want to send. Press **Menu** (right softkey) and select the **Send** or **Beam** option.
- In the Messaging application, you can insert a picture or attach a note or other file to an email. You can also receive pictures and attachments (see [Your email](#)).
- You can attach a picture, video, or sound file to a multimedia message (see [Creating and sending a multimedia message](#)).
- You can synchronize to share info between your smartphone and your computer or between your smartphone and Microsoft Exchange Server 2003 or 2007 (see [Synchronizing information](#)).
- If you are near someone, you can beam files and applications between your smartphone and your neighbor's device using the IR port or Bluetooth® wireless technology (see [Beaming information](#)).

- You can also store files on an expansion card and share the expansion card (see [Using expansion cards](#)).

Beaming information

Your smartphone is equipped with an IR (infrared) port that enables you to beam information to another device with an IR port. The IR port is located on the side of your smartphone closest to the stylus, near the top. You can also beam using the Bluetooth wireless technology on your smartphone.

The normal range for beaming with IR is about 20 centimeters (eight inches). The maximum range for beaming with Bluetooth technology is about 10 meters (30 feet). Performance and range are affected by physical obstacles, radio interference from nearby electronic equipment, and other factors.

TIP For best results, the path between the two devices must be clear of obstacles, and both devices kept stationary. If you have difficulty beaming, shorten the distance and avoid bright sunlight.

DID YOU KNOW? The type of information you can beam depends on the type of device you are beaming to. Other Windows Mobile 6 Professional devices are always compatible with your Treo Pro smartphone.

Beaming an entry or file

BEFORE YOU BEGIN To beam using Bluetooth technology, make sure your smartphone has the Bluetooth feature turned on (see [Entering basic Bluetooth settings](#)).

- 1 Highlight the entry or file you want to beam.
- 2 Press **Menu** (right softkey) and select **Beam...** (the menu item changes names based on the type of item you highlighted). In Contacts, press **Menu** (right softkey) and select **Send Contact > Beam**.

3 Do one of the following:

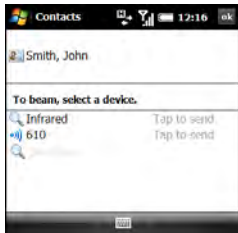

Bluetooth: When the name of the receiving device appears, select it to begin the transfer. A blue icon indicates a Bluetooth connection.

IR: Select **Infrared**. Point the IR port on your smartphone directly at the IR port of the receiving device. A red icon indicates an IR connection.

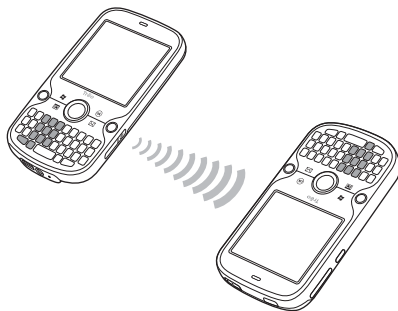



4 Wait for **Done** to appear next to the name of the receiving device before you continue using your smartphone.

TIP The regional setting determines the list of characters that can be used when info is beamed between devices. If you try to send or receive a character that is not on the list, it appears as a question mark (see [Setting display formats](#)).

Turning on the option to receive beamed information

By default, the option to receive beamed information on your smartphone is turned off. You need to turn the beam option on before you can receive information being beamed from another device.

- 1 Press **Start**  and select **Settings**.
- 2 Select the **Connections** tab, and then select **Beam** .
- 3 Check the **Receive all incoming beams** box.

Receiving beamed information

- 1 Press **End**  to turn on your screen if it is not already on.
- 2 If you are beaming over an IR connection, point the IR port on your smartphone directly at the IR port of the transmitting device.
- 3 When the Receiving Data message appears, select **Yes** to receive the beam.

Using expansion cards

The expansion card slot on your smartphone enables you to add microSD cards to extend the storage capacity of your smartphone. For example, microSD expansion cards can store the following:

- Pictures
- Games
- Videos
- Applications
- MP3 audio files
- Databases
- Email attachments

Expansion cards are sold separately.

TIP We recommend that you purchase preformatted expansion cards. To format a card on your own, you need to connect a card reader (sold separately) to your computer.

Inserting and removing expansion cards

- 1 With the back panel facing you, press the lower-right corner of the back panel with your right thumb to release the panel. Remove the panel.



- 2 Insert the card with the label facing up and the notch pointing toward the Wi-Fi button.
- 3 Push the card into the slot until you feel the card click into place.

TIP The expansion card slot has a push-push mechanism: push in gently to insert a card; push in gently to remove it.

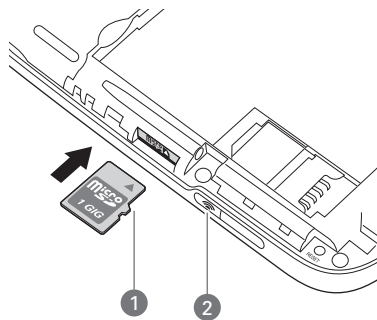



- 1 Notch
 - 2 Wi-Fi button
- 4 Replace the back panel.
 - 5 To remove an expansion card, repeat step 1 to remove the back panel, and then push the card in to release it.
 - 6 Replace the back panel.

Opening applications on an expansion card

After you insert an expansion card into the expansion card slot, you can open any of the applications stored on the expansion card.

TIP To run an application on an expansion card, your smartphone must have enough free space in the internal memory to run the application.

- 1 Insert the expansion card into the expansion card slot.
- 2 Press **Start**  and select **Programs**.
- 3 Select **File Explorer** .
- 4 Tap the **Show list** in the upper-left and select **Storage Card**.

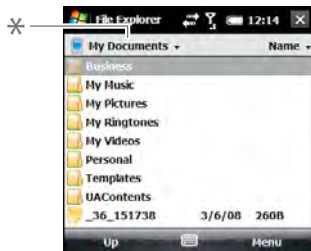

* Show list

- 5 Select the application you want to open.

Saving files to an expansion card

You can save space on your smartphone by saving files to an expansion card. For example, when you create new Word Mobile documents, notes, Excel® Mobile workbooks, pictures, videos, and audio files, you can save them directly to an expansion card. Saving files to an expansion card also makes it easy to share those files with others. (Some applications may not support this feature.)

- 1 Insert an expansion card into the expansion card slot.



- 2 Open the application from which you want to save the info.
 - 3 Press **Menu** (right softkey) and select **Options** or **Tools > Options**.
 - 4 Select the option for where to save info, and then select **Storage Card**. The option name changes depending on the application you are in.
- TIP** If you don't see a Save to option on the Options screen, look on the other tabs (if present). If you still can't find a Save to list, the application may not support this feature.
- 5 Press **OK** .

Moving info between your smartphone and an expansion card from within an application

In certain applications—for example, Pictures & Videos and the Office Mobile applications—you can move files directly to another location. For applications that do not support this feature, see [Moving info between your smartphone and an expansion card using File Explorer](#).

- 1 Insert an expansion card into the expansion card slot.
- 2 Open the application from which you want to move the info.
- 3 Go to the list view, tap the **Show** list in the upper-left, and highlight the file or application you want to move.
- 4 Press **Menu** (right softkey) and select **Rename/Move**.
- 5 Select the **Location** list, and then select where you want to move the info: **Storage card** or **Main memory**.
- 6 Press **OK** .



Moving info between your smartphone and an expansion card using File Explorer

- 1 Insert the expansion card into the expansion card slot.
- 2 Press **Start**  and select **Programs**.
- 3 Select **File Explorer** .
- 4 Highlight the file or application you want to copy or move (see [Exploring files and folders](#)).



TIP Your applications are usually located in the My Device/Program Files folder.

- 5 Press **Menu** (right softkey) and select **Edit > Copy** or **Edit > Cut**.
- 6 Go to the folder where you want to place the selected item.
- 7 Press **Menu** (right softkey) and select **Edit > Paste**.
- 8 Press **OK** .

Viewing available expansion card memory

- 1 Insert the expansion card into the expansion card slot.
- 2 Press **Start**  and select **Settings**.
- 3 Select the **System** tab, and then select **Memory** .
- 4 Select the **Storage Card** tab.
- 5 Press **OK** .

Exploring files on an expansion card



- 1 Insert the expansion card into the expansion card slot.
- 2 Press **Start**  and select **Programs**.
- 3 Select **File Explorer** .
- 4 Tap the **Show** list in the upper-left and select **Storage Card**.

- 5 Select the folder or files you want to view.
- 6 Press **OK** .

Renaming an expansion card

If you change the contents of an expansion card, you may want to rename the card to better match its contents.

TIP Before copying information to or renaming the files or folders on an expansion card, or renaming the card itself, make sure the card is not write-protected. See the instructions that came with your card for details.

- 1 Insert the expansion card into the expansion card slot.
- 2 Press **Start**  and select **Programs**.
- 3 Select **File Explorer** .
- 4 Tap the **Show** list in the upper-left and select **My Device**.
- 5 Highlight the current expansion card name (Storage Card by default).
- 6 Press **Menu** (right softkey) and select **Rename**.
- 7 Enter a new name for the card.
- 8 Press **OK** .

Encrypting an expansion card

When you encrypt an expansion card, the info on the card can be read only by your smartphone—so no one can see what's on the card if it gets lost or stolen.

- 1 Insert the expansion card into the expansion card slot.
- 2 Press **Start**  and select **Settings**.
- 3 Select the **System** tab, and then select **Encryption**.
- 4 Check the **Encrypt files when placed on a storage card** box.

NOTE If your organization enforces an encryption policy, you can see that the box is checked but cannot uncheck it.



Accessing information on a remote computer

Remote Desktop Mobile is a technology that allows you to use your smartphone to connect to a remote computer in a different location. For example, you can



connect to your work computer and have access to all of your applications, files, and network resources as though you were in front of your computer at work. You can leave applications running at work and then see your work computer's desktop displayed on your smartphone, with the same applications running.

Accessing a remote computer

BEFORE YOU BEGIN Ask the remote computer administrator for your computer username, password, and domain if you don't know them.

- 1 Press **Start**  and select **Programs**.
- 2 Select **Remote Desktop Mobile** .
- 3 Enter the name of the computer you want to access. If you are accessing a computer you've already entered, select the computer name from the list.
- 4 Enter the username, password, and domain you use to access the remote computer.
- 5 Press **OK** .

Customizing Remote Desktop Mobile

- 1 Press **Start**  and select **Programs**.
- 2 Select **Remote Desktop Mobile** .
- 3 Press **Menu** (right softkey) and select **Options**.
- 4 On the Display tab, select any of the following options:

Colors: Set how to display colors from the remote computer on your smartphone screen.

Full screen: Set whether you want the remote computer display to take up your entire smartphone screen

Fit remote desktop to screen: Set whether you want to resize the remote computer display so that the entire display fits on your smartphone screen.

- 5 Select the **Resources** tab, and then select one or both of the following options:

Device storage: Set whether to map your smartphone's storage memory to the remote computer.

Remote desktop sound: Sets whether sounds from the remote computer are muted completely, played on the remote computer, or played on your smartphone.

- 6 Press **OK** .







Calculator

You can use Calculator for basic arithmetic calculations, such as addition, subtraction, multiplication, and division.



Performing calculations

- 1 Press **Start**  and select **Calculator**.

- 2 Enter numbers and perform calculations, including the following:
-  Clears the last digit in a multi-digit entry.
 -  Clears the current calculation or the displayed number.
 -  Calculates the reciprocal of a number.
 -  Calculates percentage.
 -  Calculates the square root of a number.
 -  Switches a number between negative and positive.



TIP You can paste numbers into Calculator as well as copy calculation results to be pasted into another app.

TIP For more advanced calculations, use Excel Mobile. See [Excel Mobile](#)[®] for details.

Using the Calculator memory

- To store a displayed number, tap the box to the left of the entry box. An **M** appears in the box.

DID YOU KNOW? When you store a number in memory, it replaces the number that is currently stored.

- To add the displayed number to the number stored in memory, tap  or press **P**.
- To display the number stored in memory, tap .
- To clear the memory, tap .



Your personal settings

Customizing is optional. But why not personalize your Palm® Treo™ Pro smartphone to make it match your lifestyle and work even harder for you?

You can easily customize the sounds, fonts, screen colors, and more on your smartphone. Take advantage of various levels of security. Prevent making an accidental (and expensive) phone call by locking the keyboard. Some preference settings can help extend the life of your battery. There are lots of ways to make your smartphone work better for you.

Benefits

- Conserve power
- Make your screen easy to read
- Secure your phone and your data
- Streamline smartphone use

In this chapter

Today screen settings	287
System sound settings	288
Display and appearance settings	290
Application settings	292
Locking your smartphone and info	297
System settings	302
Connection settings	309

Today screen settings

Selecting your Today screen background

- 1 Press **Start**  and select **Settings**.

TIP You can also open Settings from your Today screen by pressing **Settings** (right softkey).

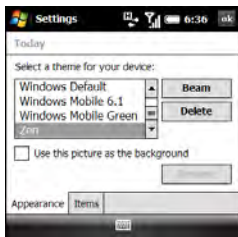

- 2 On the Personal tab, select **Today** .



- 3 On the Appearance tab, check the **Use this picture as the background** box.
- 4 Select **Browse**.
- 5 Select the picture you want to use.
- 6 Press **OK** .

TIP To change the color theme for your smartphone, select a new theme from the Appearance tab in Today Settings (see [Changing the system color scheme](#)).

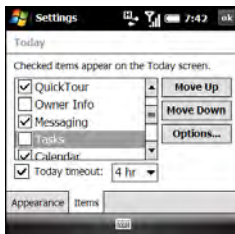

Selecting which items appear on your Today screen

- 1 Press **Start**  and select **Settings**.
- 2 On the Personal tab, select **Today** .
- 3 Select the **Items** tab.



- 4 Check the boxes next to the items you want to appear on your Today screen, and uncheck any items that you do not want to appear.
- 5 (Optional) Highlight an item and select **Move Up** or **Move Down** to change the

order in which items appear on the Today screen.

- (Optional) Highlight an item and select **Options** (if available) to configure the settings for the item. Press **OK**  to return to Today Settings.
- Press **OK** .

DID YOU KNOW? There are lots of third-party plug-ins available for your Today screen.

System sound settings

When you're in a meeting, at the movies, or anywhere that silence is required, you can immediately silence all sounds on your smartphone, including Calendar notifications and system sounds. This does not mute the speaker during phone calls.

Silencing sounds

- Slide the **Ringer** switch to **Sound Off** . The smartphone vibrates briefly.

- To hear all sounds again, slide the **Ringer** switch to **Sound On** .

When you slide the Ringer switch back to the Sound On position, it restores the previous sound settings. For example, if the smartphone ring volume is set to the loudest setting and you slide the Ringer switch to Sound Off, you do not hear the smartphone ring. When you move the Ringer switch back to Sound On, the smartphone ring volume is still set to the loudest setting.

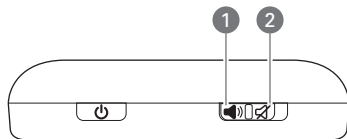



- Sound On
- Sound Off

TIP Can't get music to play out of the built-in MP3 player? Check the Ringer switch. If it's set to Sound Off, you won't be able to hear music.

DID YOU KNOW? Your smartphone includes a silent alarm that can vibrate even when the Ringer switch is set to Sound Off.

Selecting Sounds & Notifications

- 1 Press **Start**  and select **Settings**.
- 2 On the Personal tab, select **Sounds & Notifications** .
- 3 On the Sounds tab, set any of the following options:

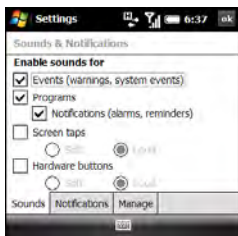

Events: Turns sounds on/off for system warnings and error messages.

Programs: Turns sounds on/off in the applications on your smartphone.

Notifications: Turns alarms and reminders on/off in the applications on your smartphone.

Screen taps: Turns sounds associated with tapping the screen on/off, and sets

the volume level when this sound is turned on.

Hardware buttons: Turns sounds associated with pressing buttons on/off, and sets the volume level when this sound is turned on.

TIP To add, preview, delete, and send sounds, select the **Manage** tab. To add a sound, press **Menu** (right softkey), select **Add**, and navigate to the sound file. To play a sound, select it and press **Play** (left softkey). To delete a sound, highlight it and press **Backspace**. To send a sound, highlight it, press **Menu** (right softkey), and select **Beam Sound** or **Send Sound**.

- 4 Select the **Notifications** tab and set any of the following options:



Event: Specifies the action for which you want to change the settings.

NOTE The settings described here apply to all event types except phone calls. To set notifications for the various phone call types, see [Selecting ringtones and display notices](#).

Play sound: Lets you turn the sound on/off for the selected event. To select a different sound, select the list to the right of this setting, and then select a different sound. To preview the sound, select **Play Sound**, and then select **Play**.

Repeat: Indicates whether the sound plays more than once, if turned on.





Display message on screen: Indicates whether a notification message appears onscreen for the selected event.

Vibrate when ringer switch off/on: Indicates whether your smartphone vibrates to notify you about the selected event.





- 5 Press **OK** .

Display and appearance settings

Adjusting the brightness



- 1 Press **Option**  and then press **P** .
- 2 Press **Left**  and **Right**  to adjust the brightness for when your smartphone is running on battery power and when it is running on external power.
- 3 Press **OK** .

Changing the text size and clarity



- 1 Press **Start**  and select **Settings**.
- 2 Select the **System** tab, and then select **Screen** .
- 3 Select the **Text Size** tab.
- 4 Press **Left**  and **Right**  to adjust the text size.
- 5 Select the **Clear Type** tab.
- 6 To smooth the edges of screen fonts, check the **Enable Clear Type** box.
- 7 Press **OK** .

Displaying the clock

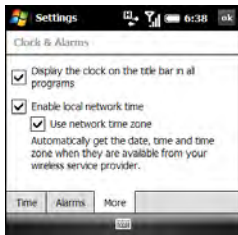

You can display a clock at the top of every screen. You can also choose between a digital and an analog clock display.

- 1 Press **Start**  and select **Settings**.
- 2 Select the **System** tab, and then select **Clock & Alarms** .
- 3 Select the **More** tab.



- 4 To display the clock, check the **Display the clock on the title bar in all programs** box.
- 5 Press **OK** .
- 6 To change the clock display format, tap and hold the clock and select **Analog** or **Digital**. If you select analog format, a clock icon  appears displaying the time.

Setting display formats

- 1 Press **Start**  and select **Settings**.
- 2 Select the **System** tab, and then select **Regional Settings** .

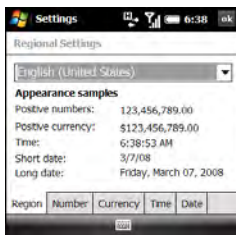

- 3 On the Region tab, select a region from the list. The region selection determines all display formats (date, time, and so on) on your smartphone unless you use another Regional Settings field to select a different format for a specific type of display item.
- 4 (Optional) Select any of the following tabs to customize individual format settings:

Number: Sets the decimal symbol and number of decimal places, the digit grouping symbol and group size, list

separators, negative number sign symbol and format, leading zero display, and measurement system (metric vs. U.S.).

Currency: Sets the currency symbol and position, the decimal symbol and position, digit grouping symbol and group size, and negative number format.



Time: Sets the time style, separators, and AM and PM symbols.

Date: Sets the short date style, separators, and long date style.

- 5 Press **OK** .

Aligning the screen to correct tapping problems

Occasionally, your screen may need to be readjusted. You know your screen needs adjustment when the wrong feature is activated when you tap the screen. To fix the problem, align the screen.

- 1 Press **Start**  and select **Settings**.
- 2 Select the **System** tab, and then select **Screen** .

- 3 On the General tab, select **Align Screen**.

- 4 Tap the screen where indicated.

- 5 Press **OK** .

Changing the system color scheme

- 1 Press **Start**  and select **Settings**.

- 2 On the Personal tab, select **Today** .

- 3 On the Appearance tab, select a theme in the list.

- 4 Press **OK** .

TIP You can also set the background for your Today screen (see [Selecting your Today screen background](#)).

Application settings

Arranging the Start menu

You can change the seven applications listed on the Start menu. You can still access the remaining applications by selecting Programs from the Start menu, and then selecting the application's icon.

- 1 Press **Start**  and select **Settings**.

- 2 On the Personal tab, select **Menus** .

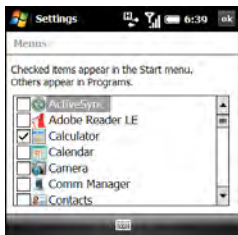



- 3 Check the boxes next to the applications you want to see in the Start menu.
- 4 Press **OK** .

TIP Don't forget the six icons across the top of the Start menu. They're the apps you opened most recently, and it's easy to get back to them: just use the 5-way to select one of the icons.

Reassigning buttons

You can use Buttons Settings to select which applications to associate with many of the buttons and key combinations on your smartphone.

- 1 Press **Start**  and select **Settings**.
- 2 On the Personal tab, select **Buttons** .

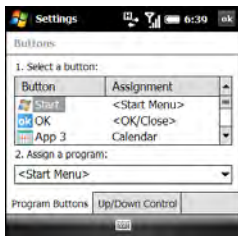

- 3 On the Program Buttons tab, highlight the button or key combination you want to change in the Button list. The hardware buttons are mapped to the following items:

Start  = Start menu

OK  = OK/Close

Option  + **Phone/Send**  = Internet Explorer

Option  + **Start**  = File Explorer

Option  + **OK**  = Task Manager

Option  + **Calendar**  = Calculator

Option  + **Messaging**  = Tasks

Hold Side = Camera



Select the **Assign a program** list, and then select the application you want to assign to the button or key combination you selected.

- 4 Select the **Up/Down Control** tab and adjust the settings for the **Up** ▲ and **Down** ▼ buttons on the 5-way.
- 5 Press **OK** .

Setting up voice commands

IMPORTANT The Voice Command application is available only for English, French, and German.

Voice commands enable you to use speech to execute some commands on the Start menu and the Programs screen.

- 1 Assign the **Hold Side** button to Voice Command. See [Reassigning buttons](#) for details.
- 2 Press **Start**  and select **Settings**.
- 3 On the Personal tab, select **Voice Command** .



- 4 Check the **Enabled** box.
- 5 Select the items you want to enable. If an item is highlighted and the Options button is active, select **Options** to choose the features you want enabled for the highlighted item.
- 6 Select **Notifications** and select the options for how you want to receive voice command notifications.

Using voice commands

IMPORTANT Do not use voice commands in your car until you read the End user notice about this kind of usage; see the safety and legal information included in your smartphone package for information.

- 1 Set the **Ringer** switch at the top of your smartphone to **Sound On** (🔊).
- 2 Hold your device close to your mouth and press and release the assigned **Voice Command** button (see [Setting up voice commands](#)). A tone plays and a microphone icon appears at the top of your screen.

- 3 In a clear voice say the command. For example:

To access Help: Say “Help.” After Voice Command finishes speaking, a microphone icon appears at the top of your screen. Say your answer. For example, say “General” to access general Help topics.

To access your Calendar: Say “Start Calendar.”

To access your music: Say “Start Windows Media.” After Voice Command finishes speaking, a microphone icon appears at the top of your screen. Say your answer.

TIP You can move quickly through voice commands by stopping the voice command response before it finishes. When Voice Command responds, you can press the **Voice Command** button before it completes the question. After the microphone icon is visible, you may say your answer.

Setting input options

- 1 Press **Start** (⊞) and select **Settings**.
- 2 On the Personal tab, select **Input** (📄).
- 3 On the Input Method tab, set any of the following options:

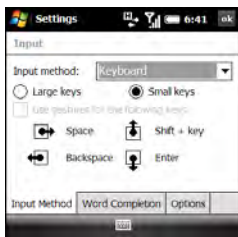

NOTE The Input Method options you specify apply only to entering info using the screen. You can still enter info using your smartphone’s keyboard regardless of the onscreen input method you choose.

Input method: Specifies which onscreen input method you want to use:

- **Block Recognizer:** Use a single stroke to write letters, numbers, symbols, and punctuation, which are then converted into typed text. Use gestures to enter Return and Backspace.
- **Keyboard:** Tap keys on the onscreen keyboard to enter text.
- **Letter Recognizer:** Write individual letters, numbers, and punctuation, which are converted into typed text.

Large/Small keys: If you selected Keyboard, select whether to use large or small onscreen keys. If you select Large keys, check the box if you want to use gestures for the space bar and the Backspace, Shift, and Return keys.

Options: If you selected Letter Recognizer, select Options and select the options you want.

- 4 Select the **Word Completion** tab and set any of the following options:

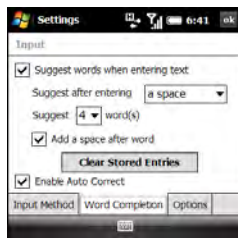

Suggest words when entering text:

Indicates whether word suggestions appear as you enter text. You can also specify how many letters you want to enter before a suggestion appears, how many suggestions you want to see, and whether a space appears after you insert a suggested word.

TIP To enter a suggested word, press **Down** to highlight the suggestion, and then press **Center** to accept it.

Clear Stored Entries: Deletes the database of word suggestions.

Enable Auto Correct: Indicates whether common misspellings such as “teh” are corrected automatically.

- 5 Select the **Options** tab and set any of the following options:

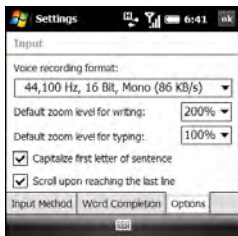

Voice recording format: Specifies the format in which you save voice notes.

Default zoom level for writing: Specifies the initial size of text entered from onscreen writing methods.

Default zoom level for typing: Specifies the initial size of text entered using the keyboard.

Capitalize first letter of sentence: Specifies whether the first letter of a sentence automatically appears in uppercase, without requiring you to press a Shift key.

Scroll upon reaching the last line: Specifies whether the display automatically scrolls when you select the last line of visible info.

- 6 Press **OK** .

Locking your smartphone and info

Your smartphone includes several features that help you protect it from inadvertent use and keep your information private. The security software lets you use your smartphone for emergency calls, such as dialing your national emergency number (such as 911, 112, or 999), even if it is locked.

Keyguard: Manually disables all buttons and the screen's touch-sensitive feature to prevent accidental presses in your briefcase or pocket.

Auto-Keyguard and touchscreen lockout: Automatically enables Keyguard after a period of inactivity and lets you

disable the screen's touch-sensitive feature during an active call.

SIM card Lock: Requires a PIN to turn on your phone so you can make and answer calls.

System password lock: Requires a password to see any information on your smartphone.



TIP To avoid accidentally pressing onscreen buttons while you're holding your smartphone up to your ear to speak, you can disable the screen's touch-sensitive feature during active calls. When the screen's touch-sensitive feature is disabled, you must use the 5-way navigator to access items on the screen.

Locking your keyboard (Keyguard)

By default, your keyboard locks so that you don't accidentally press buttons or activate screen items while your smartphone is in a pocket or bag.

To dismiss Keyguard: Press **Center** .

To manually turn on Keyguard when your smartphone screen is on: Do one of the following:



- Press and hold **End** .
- Press **Option**  + **End** .

TIP If you're using a headset or hands-free device and your smartphone is in a pocket or bag, you can manually turn on Keyguard during a call to prevent accidental key presses

TIP If your Today screen is displayed and you're not on a call, you can also turn on Keyguard by pressing **End**.

Turning on Auto-Keyguard

Auto-Keyguard enables you to configure the Keyguard feature.

- 1 Press **Start**  and select **Settings**.
- 2 On the Personal tab, select **Keyguard** .
- 3 Select the **Auto-Keyguard** list and disable the Auto-Keyguard feature or set the period of inactivity that passes before the keyboard automatically locks.



- 4 Press **OK** [OK].

Locking your screen

- 1 Press **Start** [Start] and select **Settings**.
- 2 On the Personal tab, select **Keyguard** [Keyguard].
- 3 Under Disable touchscreen, check or uncheck the **While on a phone call** box to determine whether the screen's touch-sensitive feature is disabled during a call.
- 4 Press **OK** [OK].

Locking the SIM card

You can lock your SIM (Subscriber Identity Module) card to prevent unauthorized use of your mobile account. When your SIM

card is locked, you must enter the PIN to power on your phone to make or receive calls, except for emergency numbers. The SIM card remains locked even if you move the card to another phone.

To unlock your SIM card, turn on the phone and enter your PIN.

BEFORE YOU BEGIN Make sure your phone is on and that you're inside a coverage area (see [Turning your phone on](#)). Get your default PIN from your wireless service provider.

- 1 Press **Start** [Start] and select **Settings**.
- 2 On the Personal tab, select **Phone** [Phone].
- 3 Select the **PIN** tab.



- 4 Check the **Require PIN when phone is used** box.
- 5 Enter the PIN and press **OK** .
- 6 Turn your phone off to activate the phone lock feature.

Your SIM card locks when you turn off your phone and turn it back on. When your SIM card is locked, you can unlock your SIM card by entering your PIN.



TIP If your wireless service provider changes the PIN, you need to change it on your smartphone. Press **Start** and select **Settings**. On the Personal tab, select **Phone**. Select the **PIN** tab, and then select **Change PIN**.

NOTE You need your PIN number to edit your PIN number or remove the locking feature. If you enter an incorrect PIN more times than allowed by your wireless service provider, the SIM card locks. After the SIM card locks, you need the PUK to unlock the SIM card. Contact your wireless service provider for more information and the PUK.

Locking your smartphone

To protect your personal information, you can lock the system so that you need to enter your password to access any of your information or use other features of your smartphone.

IMPORTANT If you lock your system, you must enter the exact password to unlock it. If you enter an incorrect password, you are given another chance. Each time an incorrect password is entered, you are given progressively longer time periods between your chances to enter the password. If you forget the password, you need to perform a hard reset to resume using your smartphone. Performing a hard reset deletes all the entries in your smartphone. However, you can restore all previously synchronized info the next time you sync (see [Synchronizing information](#)).

- 1 Press **Start**  and select **Settings**.
- 2 On the Personal tab, select **Lock** .
- 3 On the Password tab, check the **Prompt if device unused for** box to turn on the password feature.

4 Select the first list, and then select how long a period of inactivity must pass before you are prompted to enter a password to unlock the system.

5 Select the **Password type** list, and then select a format for your password:

Strong alphanumeric: A strong alphanumeric password must contain at least seven characters and must contain a combination of letters, numerals, and punctuation. You must press Option or Alt before entering numerals or punctuation.

Simple PIN: A simple PIN must contain at least four characters and includes numerals only. You do not need to press Option before entering the PIN numerals.

6 Select **Password** and enter your password.

7 Select **Confirm** and enter the password again.



8 (Optional) Select the **Hint** tab and enter a hint to help you recall your password.

9 Press **OK** .

TIP If you lock your smartphone and use a Simple PIN as the password, you can dial an emergency number by entering the number in the password field and pressing **Phone/Send**. You do not need to press Option before entering the number. However, if you select Strong alphanumeric as the password type, you must first press **Option** twice before entering an emergency number in the password field.

Entering owner information

You can enter personal information that you want to associate with your smartphone, such as your name, company name, and phone number. You can also set whether you want this information to appear when you turn on your smartphone. If you lose your smartphone, this feature can help the person who finds it return it to you.

- 1 Press **Start**  and select **Settings**.
- 2 On the Personal tab, select **Owner Information** .
- 3 On the Identification tab, enter any of the information you want to include.

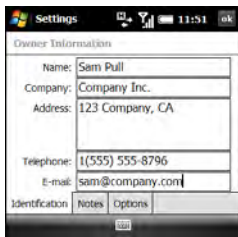

- 4 Select the **Notes** tab and enter any additional text you want to include.
- 5 Select the **Options** tab and check the boxes to indicate which info (if any) you want to appear on the screen when you turn on your smartphone.
- 6 Press **OK** .



TIP You can also display your Owner Information on your Today screen. See [Selecting which items appear on your Today screen](#) for details.

System settings

Setting the date and time

Use Clock & Alarms Settings to set the time zone, time, and date for your home location and a location that you visit.

To set the display format for the date and time, see [Setting display formats](#).

- 1 Press **Start**  and select **Settings**.
- 2 Select the **System** tab, and then select **Clock & Alarms** .
- 3 On the Time tab, select **Home**.

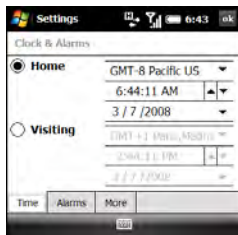

- 4 Select the first list, and then select the time zone for your home location.

- 5 Select the hour and press **Up** ▲ or **Down** ▼ to increase or decrease the hour setting. Repeat this process for the minute, seconds, and AM/PM settings.
 - 6 Select the month and press **Up** ▲ or **Down** ▼ to increase or decrease the month setting. Repeat this process for the date and year settings.
 - 7 (Optional) Select **Visiting** and set the info for a location that you visit often.
 - 8 Press **OK** (Ⓞ).
 - 9 If prompted, select **Yes** to accept your changes.
- 4 To disable this option, uncheck the **Enable local network time** box.
 - 5 If you want to keep your smartphone date and time set for your selected location, uncheck the **Use network time zone** box.

Synchronizing the date, time, and time zone with the network

By default your smartphone synchronizes the date, time, and time zone with your wireless service provider's network whenever your phone is on and you are inside a coverage area.



- 1 Press **Start** (Ⓜ) and select **Settings**.
- 2 Select the **System** tab, and then select **Clock & Alarms** (🕒).
- 3 Select the **More** tab.

Setting system alarms

System alarms let you set alarms that are not associated with a task or appointment. For example, you can use your smartphone as an alarm clock when you travel, or set alarms to remind you when it's time to take medication or pick up the kids.

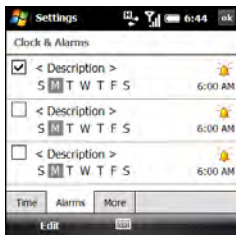
- 1 Press **Start** (Ⓜ) and select **Settings**.
- 2 Select the **System** tab, and then select **Clock & Alarms** (🕒).
- 3 Select the **Alarms** tab.



- 4 Check a box to turn on that alarm.
- 5 Select **Description** next to the box you checked and enter a description for the alarm.
- 6 Tap the days of the week you want the alarm to go off. You can select multiple days for each alarm.
- 7 Tap the time, set the time you want the alarm to go off, and press **OK** .
- 8 Select the **alarm**  icon and check the boxes to select how you want the alarm to go off. You can choose a single sound, a repeating sound, a flashing light, or vibration.



TIP To change the alarm sound, select the alarm sound icon, select the **Play Sound** list, and then select the alarm sound you want to use.

- 9 Press **OK**  twice.
- 10 If prompted, select **Yes** to accept your changes.

Managing identity certificates

Your smartphone may include preinstalled certificates. Certificates are digital

documents that are used to authenticate and exchange information on networks. Certificates can be issued for a user, a device, or a service.

- 1 Press **Start**  and select **Settings**.
- 2 Select the **System** tab, and then select **Certificates** .
- 3 Select any of the following tabs:

Personal: Displays certificates that establish your identity when you log in to a secured network, such as a corporate network.

Intermediate: Displays certificates issued from a root certificate whose purpose is to then issue personal certificates.

Root: Displays certificates that identify the computers, such as servers, to which you connect. These certificates help prevent unauthorized users from accessing your smartphone and information.

- 4 To view certificate details, select the certificate.
- 5 Press **OK** .



TIP To delete a certificate, highlight the certificate name, press and hold **Center** on the 5-way, and then select **Delete** from the shortcut menu.

Enabling error reporting



Error Reporting sends info that helps diagnose application errors for devices running Windows Mobile® software. When an error is detected, a text file is created. You can review the file and choose whether you want it delivered to Microsoft Support. The information is used by programming groups at Microsoft for quality control and is not used for tracking individual users or installations for any marketing purpose. The info that is collected is technical info about the state of your system when the error occurred. No documents (or any info contained in them) are intentionally sent with the report. To ensure further security, the report is transmitted via a secure connection and is kept confidential and anonymous in a limited-access database.

DID YOU KNOW? This error reporting method meets the privacy regulations of the European Union (EU) as well as the Fair Information Practice Principles of the Federal Trade Commission in the United States. To view the Fair Information Practice Principles, visit the Federal Trade Commission website at ftc.gov/reports/privacy3/fairinfo.htm

Your smartphone must be connected to your computer when you send the error report—provided your computer is connected to the Internet.

- 1 Press **Start**  and select **Settings**.
- 2 Select the **System** tab, and then select **Error Reporting** .
- 3 Select whether you want to enable or disable error reporting.
- 4 Press **OK** .

How much storage space do I have left?

- 1 Press **Start**  and select **Settings**.
- 2 Select the **System** tab, and then select **Memory** .
- 3 Select either of the following tabs:
Main: Displays the amount of memory assigned to your applications and info,

as well as the amount of memory in use versus the available memory.

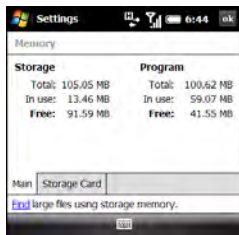



TIP If storage memory is low, consider using an expansion card to store files (see [Using expansion cards](#)). If program memory is low, close some applications to avoid slow smartphone performance (see [Closing applications](#)). You can also tap **Find** at the bottom of the screen to search for large files to delete and free up memory.

TIP You can also open Memory settings by selecting the **running programs** icon in the upper-right corner of the Today screen, and then selecting the **memory** icon.

Storage Card: Displays the amount of memory available on an expansion card that is inserted in the expansion slot on your smartphone.

4 Press **OK** .

Optimizing power settings

- 1 Press **Start**  and select **Settings**.
- 2 Select the **System** tab, and then select **Power** .
- 3 On the Battery tab, view the power remaining in your battery.



TIP An easy way to check the battery level is by tapping the **battery** icon in the title bar.

- 4 Select the **Advanced** tab and set whether your smartphone screen turns off automatically after a specified period of inactivity. You can assign different intervals for battery power and external power.



- 5 Select the **Screen Saver** tab, and check the box to enable the screen saver feature, or uncheck it to disable the screen saver.
- 6 Press **OK** .

TIP To conserve additional battery power, disable the screen saver, or adjust the screen backlight setting. Press **Start** and select **Settings**. Select the **System** tab, and then select **Backlight**. On the Battery Power tab, set whether the display backlight turns off automatically after a period of inactivity. You can also select the External Power tab to turn off the backlight when your smartphone is connected to an external charging source.

Turning wireless services on/off

To quickly turn all wireless services on or off, press and hold **Power** .

Follow these steps to turn individual wireless features on or off.

- 1 On the Today screen, select your wireless service provider name, or select **Phone off** if your wireless service provider name is not displayed.

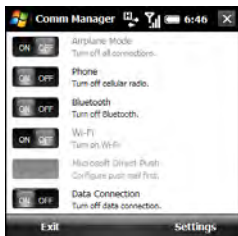

- 2 Select a wireless feature to turn it on or off. The current state of the feature, ON or OFF, appears on a gray background. The description of the feature tells you what you can change it to. In the illustration, Airplane Mode and Wi-Fi are off, and Phone and Bluetooth are on.

TIP To change the settings for one of the displayed wireless features, press **Settings** (right softkey) and select the wireless feature you want to change.

3 Press **OK** [OK].

You can also turn wireless services on and off by tapping the **signal-strength** [signal strength] icon at the top of the screen and selecting **Comm Manager**.

Updating the system software

Windows Update for Windows Mobile lets you download security updates and other important updates to the Windows Mobile operating system software on your smartphone.

- 1 Press **Start** [Start] and select **Settings**.
- 2 Select the **System** tab, and then select **Windows Update**.

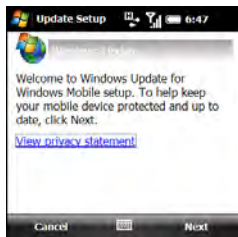

- 3 On the Update Setup screen, press **Next** (right softkey).

TIP Select **View privacy statement** to read about how using Windows Update affects the personal information on your smartphone.

- 4 Select whether you want to run Windows Update manually or you want it to check for updates automatically, and press **Next** (right softkey).
- 5 If you selected automatic updates, check the **Use my data plan to check for and download updates** box if you want to use your data plan instead of your basic wireless plan to update your

smartphone. Using your data plan means that updates may occur more frequently but may result in additional data charges. Press **Next** (right softkey).

6 Press **Finish** (left softkey).

If you selected Automatic in step 4, Windows Update periodically checks for and downloads updates automatically. If you selected Manual in step 4, you can check for updates at any time by opening Windows Update and pressing **Check Now** (left softkey).

To view detailed results of the last check for updates, press **Menu** (right softkey) and select **View details**.

TIP To switch between manual and automatic updates, open Windows Update, press **Menu** (right softkey), and select **Change Schedule**. To select or deselect the option to use your data plan to check for and download updates, press **Menu** (right softkey) and select **Connections**.

Connection settings



Managing ISP settings

Your smartphone is already set up to connect to the Internet using a high-speed data connection on your wireless service provider's network. To connect to the Internet, simply start Internet Explorer Mobile.

For special situations, such as connecting to your internet service provider (ISP) or to a remote access server (RAS), you can set up another connection.

BEFORE YOU BEGIN Obtain the following information from your ISP or system administrator:

- ISP server phone number or access point
- Username
- Password

- 1** Press **Start**  and select **Settings**.
- 2** Select the **Connections** tab, and then select **Connections** .
- 3** On the Tasks tab, select **Manage existing connections**.



- 4 Select the **Modem** tab.
- 5 Highlight the connection you want to view or change and select **Edit**, or select **New** to create a new connection.
- 6 Follow the onscreen instructions to edit or create the connection.

Connecting to a VPN

If you want to use your smartphone to access your corporate email account or other files on your corporate server, you may need to set up a VPN (virtual private network). A VPN enables you to log in to your corporate server through the company's firewall (security layer).



BEFORE YOU BEGIN Check with your company's system administrator to see if a VPN is required to access the corporate network. If you need a VPN, you must purchase and install a third-party VPN client in order to use this feature.

Ask your corporate system administrator for the following information:

- Your username and password
 - Your server's domain name
 - Your server's TCP/IP settings
 - Your server's host name or IP address
- 1 Install your third-party VPN client (see [Installing applications](#)).
 - 2 Press **Start**  and select **Settings**.
 - 3 Select the **Connections** tab, and then select **Connections** .
 - 4 On the Tasks tab, select **Add a new VPN server connection**.
 - 5 Follow the onscreen instructions to enter the settings provided by your corporate system administrator.

TIP To manually start a data connection on your wireless service provider's network or another network, go to **Connections Settings**, and on the Tasks tab, select **Manage existing connections**. Tap and hold the connection you want to start, and then select **Connect** from the shortcut menu.

Setting up a proxy server

- 1 Press **Start**  and select **Settings**.
- 2 Select the **Connections** tab, and then select **Connections** .
- 3 On the Tasks tab, select **Set up my proxy server**.

- 4 Check both the **This network connects to the Internet** and the **This network uses a proxy server to connect to the Internet** boxes.
- 5 Select **Proxy server** and enter the proxy server name.
- 6 Press **OK** .

TIP To change settings such as the port number, proxy server type, or credentials, select **Advanced**.

Turning a proxy server on or off

Your wireless service provider may require a proxy server to access the Internet using your wireless service provider's data connection. However, if you connect to the Internet using a Wi-Fi (see [Connecting to a Wi-Fi network](#)) or a VPN (see [Connecting to a VPN](#)) connection, the proxy server may prevent your smartphone's web browser from locating certain websites. You can use the Internet Proxy application to turn the proxy server on or off, depending on how are you connecting to the Internet.

- 1 Press **Start**  and select **Programs**.
- 2 Select **Internet Proxy** .

- 3 Do one of the following:



Turn on the proxy server: Check the **Enable Pocket Internet Explorer Proxy** box, enter the proxy server information, and select **Apply**.

Turn off the proxy server: Uncheck the **Enable Pocket Internet Explorer Proxy** box.

- 4 Press **OK** .

Ending a data connection

If your service plan includes minutes-of-use fees for data connections, you can reduce costs by ending the data connection when you've finished browsing the web.



- 1 On the Today screen, select your wireless service provider name.
- 2 Select **Data Connection**.

Enrolling a domain

If your company uses Microsoft System Center Mobile Device Manager, you may need to use the Domain Enroll settings to register your smartphone within your company's network.

IMPORTANT After you enroll your smartphone in your company's network, your system administrator can turn various features on your smartphone on and off. If

a feature, such as the camera or messaging, worked previously and this feature no longer works after enrollment, contact your system administrator to find out if this feature is disabled on your smartphone.

- 1 Press **Start**  and select **Settings**.
- 2 Select the **Connections** tab, and then select **Domain Enroll** .
- 3 Press **Enroll** (right softkey).
- 4 Follow the onscreen instructions to complete the enrollment process.



CHAPTER

14

Troubleshooting

Although we can't anticipate all the questions you might have, this chapter provides answers to some of the most commonly asked questions. For additional information and answers to other common questions, visit palm.com/treoproumts-support.

In this chapter

Transferring info from another device	315
Reinstalling the desktop software	315
Resetting your smartphone	316
Performance.	319
Screen	320
Network connection.	321
Synchronization	325
Email	332
Web	335
Camera.	336
Third-party applications	337
Making room on your smartphone.	338
Voice quality	338

Transferring info from another device

For information on transferring your info from a previous Windows Mobile® device or from a Palm OS® by ACCESS device to your new Palm® Treo™ Pro smartphone, visit palm.com/treoproumts-support for instructions.

DID YOU KNOW? You can purchase a third-party application that lets you run Palm OS® applications on your smartphone.

DID YOU KNOW? If you have questions about Windows Mobile, you can go to windowsmobile.com. Search for Palm devices for information.

IMPORTANT Do not use a backup utility to transfer your info from another device to your new smartphone. This can cause your smartphone to malfunction.

Reinstalling the desktop software

If you have problems synchronizing using your desktop sync software, you may need to reinstall the software.

BEFORE YOU BEGIN Make sure your computer profile includes administrator rights to install software. In large organizations, these are usually granted by the system administrator.



- 1 Shut down your computer and turn it on again.
- 2 On your computer, click **Start > Control Panel > Add or Remove Programs**.
- 3 Remove your desktop software. For computers running Windows XP, the software is called Microsoft ActiveSync. For computers running Windows Vista, the software is called Windows Mobile Device Center.
- 4 Quit any active applications, including virus scanners and Internet security applications.

- 5 To reinstall the software, switch your smartphone to setup mode and connect your smartphone to your computer and follow the onscreen instructions. See [Installing the desktop sync software](#) for detailed instructions.

Resetting your smartphone

Performing a soft reset

Performing a soft reset is similar to restarting a computer. If your smartphone is not responding or you have trouble synchronizing with your computer, a soft reset may help.

- 1 If your smartphone responds to key presses, press and hold **Power**  to turn off your phone.
- 2 If the screen display is on, press **Power**  to turn off the screen.
- 3 Remove the back panel from your smartphone.
- 4 Slide the stylus out from its slot.
- 5 Use the stylus tip to gently press the reset button.
- 6 Wait for the progress bar on the Palm® logo screen to fill before continuing to use your smartphone.
- 7 Slide the back panel into place.

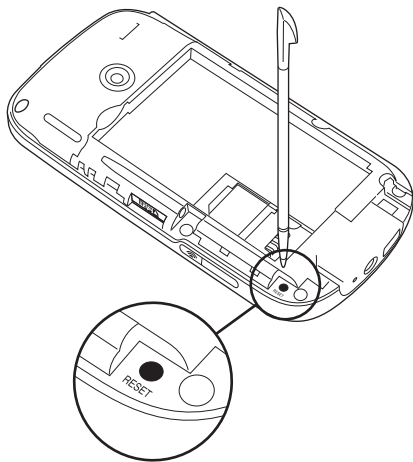

TIP You can also do a soft reset by removing the battery and reinserting it.

DID YOU KNOW? If the phone or the Bluetooth® wireless technology feature was on before a reset, these automatically turn on after the reset.

Performing a hard reset

A hard reset erases all personal information, such as appointments, contacts, and tasks, as well as programs you have added, such as third-party software on your smartphone. Never do a hard reset without first trying a soft reset. You can restore previously synchronized information the next time you sync.





IMPORTANT Synchronize to restore your Outlook data, such as Outlook email, Calendar, Contacts, Notes, and Tasks. You can use a backup and restore solution. Make sure it's an application that's approved by Palm, such as the one included on your smartphone.

TIP Some third-party applications do not create a backup on your computer when you synchronize. If you do a hard reset, you may lose info in these applications and you need to reinstall the application on your smartphone after the hard reset. Please contact the application vendor to find out if your info is backed up during synchronization.

DID YOU KNOW? When you synchronize after a hard reset, the source folder in My Documents changes from Treo My Documents to WM_your name.

A hard reset can tell you whether a problem stems from your smartphone or from an application installed on it. If you do not experience the problem after you perform a hard reset, the problem may be related to software you installed. See [Third-party applications](#) for suggestions on diagnosing third-party software issues.

- 1 Synchronize your smartphone with your computer so that your smartphone applications and info can be restored by synchronizing again after you perform the hard reset.
- 2 Remove the back panel from your smartphone.

- 3 Slide the stylus out from its slot.
- 4 If the screen is off, press **Power**  to wake up the screen.
- 5 While pressing and holding **End** , use the tip of the stylus to gently press and release the reset button.
- 6 Continue pressing and holding **End**  until the “Erase all data?” prompt appears.
- 7 Press **Up**  to confirm the hard reset.
- 8 Wait for the progress bar on the Treo logo screen to fill before continuing to use your smartphone.
- 9 Slide the back panel into place.
- 10 (Optional) Synchronize to restore your previously synchronized info. If you use a backup utility, you may also need to restore a backup to recover additional info and settings.

Replacing the battery

Your smartphone comes with a replaceable battery. Be sure to use a replacement battery from Palm that is compatible with Treo Pro models. Do not use a battery from any earlier model of smartphone.

TIP Be sure to dispose of your old battery in an environmentally responsible and legal way. In some areas, disposal in household or business trash is prohibited. Visit palm.com/environment for more information.

DID YOU KNOW? Your smartphone stores all your info even when you remove the battery.

- 1 Press **Power**  to turn off the screen.
- 2 With the back panel facing you, press the lower-right corner of the back panel with your right thumb to release the panel. Remove the panel.

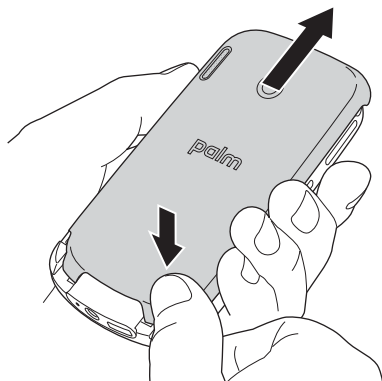

- 3 Place a finger in the notch between the stylus and the battery, and then remove the battery.
- 4 Align the metal contacts on the new battery with the contacts of the battery compartment, and then press the battery into place.

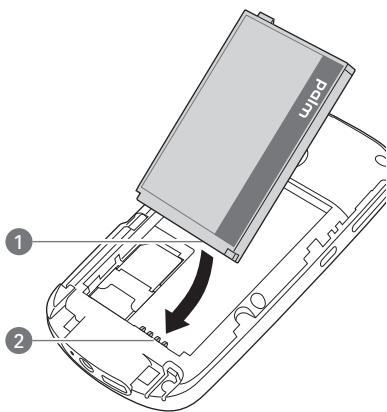



- 1 Battery contacts
- 2 Smartphone contacts



- 5 Slide the back panel into place.

Performance

The applications are running slower than usual

- 1 Press and hold **OK**  to open Task Manager.
- 2 Select **Stop All** to close all your open applications.
- 3 Press **OK** .

If the previous steps don't fix the problem, try doing a soft reset (see [Performing a soft reset](#)). If the problem persists, follow these steps to turn off the Voice Command setting, if it is enabled:

- 1 Press **Start**  and select **Settings**.
- 2 Select **Personal**, and then select **Voice Command** .
- 3 Uncheck the **Enabled** box.
- 4 Press **OK** .

TIP Be sure that third-party applications are designed for Windows Mobile 6.1 Professional. Applications written for Windows Mobile 6.1 Standard or earlier versions of Windows Mobile software do not work with your smartphone.

If you can try a free version of the software before purchasing it, you can test it first to make sure it works properly.

My battery seems to drain quickly

If you have a push email solution or if you have set up a schedule for wireless synchronization, check with your email provider or system administrator to make sure that the server is set up properly to work with your smartphone. Incorrect server setup can cause excessive drain on your battery.

For more tips on conserving battery life, see [Maximizing battery life](#).

I want to charge my smartphone by connecting it to my computer, when I connect them, a Setup screen appears

If you just want to use the connection between your smartphone and your

computer to charge your smartphone (and not to sync), you need to turn off setup mode. When the Setup screen appears on your computer, on your smartphone, press **Cancel** (right softkey), and then press **Exit** (right softkey).

Screen



The screen appears blank

- 1 If this is the first time you are turning on your smartphone, you need to take out and reinsert the battery to turn on the screen (see [Replacing the battery](#)). Alternately, connect your smartphone to a wall outlet using the USB AC charger (see [Charging the battery](#)).
- 2 If you're on a call, when the time period specified in Backlight Settings expires, the screen dims; one minute later, the screen automatically turns off. Press any key except End to wake up the screen. Pressing End hangs up the call.
- 3 Look closely at the screen. If you can see a dim image, try adjusting the

screen brightness (see [Adjusting the brightness](#)).

- 4 If that doesn't work, perform a soft reset (see [Performing a soft reset](#)).
- 5 If that doesn't work, connect your smartphone to the USB AC charger (see [Charging the battery](#)) and perform a soft reset again.
- 6 If you are using a third-party application, make sure that the application supports 320x320 screen resolution.
- 7 If that doesn't work, perform a hard reset (see [Performing a hard reset](#)).

The screen doesn't respond accurately to taps or activates wrong features

- 1 Make sure there is no debris trapped under the edges of the screen.
- 2 Press **Start**  and select **Settings**.
- 3 Select the **System** tab, and then select **Screen** .
- 4 On the General tab, select **Align Screen**.
- 5 Tap the screen where indicated.
- 6 Press **OK** .

Network connection

Signal strength is weak

- 1 If you're standing, move about 3 meters (10 feet) in any direction.
- 2 If you're in a building, move near a window. Open any metal blinds.
- 3 If you're in a building, move outdoors or to a more open area.
- 4 If you're outdoors, move away from large buildings, trees, or electrical wires.
- 5 If you're in a vehicle, move your smartphone so that it's level with a window.
- 6 Try using a hands-free Bluetooth headset to see if that improves the signal strength.

TIP Become familiar with low coverage areas where you live, commute, work, and play so you know when to expect signal strength issues.

My smartphone won't connect to the mobile network

- 1 Try the suggestions above for weak signals.
- 2 Turn off your phone and turn it on again (see [Turning your smartphone on/off](#)).
- 3 Perform a soft reset (see [Performing a soft reset](#)).

My phone seems to turn off by itself

If a system error and reset occur, the phone automatically turns on if it was on before the reset. However, if your smartphone can't determine if your phone was on before the reset, it does not automatically turn on the phone (see [Turning your phone on](#)).

I can't tell if data services are available

The following icons appear in the title bar to indicate whether data services are available:



Your phone is connected to a 3G UMTS network, but you are not actively transmitting data. You can still make or receive calls.



Your phone is on and a 3G UMTS data connection is active. You can make and receive calls and transmit data simultaneously.



Your phone is connected to a HSDPA UMTS network, but you are not actively transmitting data. You can still make or receive calls.

NOTE In most cases, when your phone is connected to a UMTS network (either 3G or HSDPA) but you are not actively transmitting data, the 3G icon appears. The H icon may appear when your phone is connected to a HSDPA UMTS network, but you are not actively transmitting data.



Your phone is on and an HSDPA UMTS data connection is active. You can make and receive calls and transmit data simultaneously.

E

Your phone is connected to an EDGE network, but you are not actively transmitting data. You can still make or receive calls.

E →

Your phone is on and an EDGE data connection is active. You can still make or receive calls, but the data transmission is automatically interrupted.

G





Your phone is connected to a GPRS network, but you are not actively transmitting data. You can still make or receive calls.

G →

Your phone is on and a GPRS data connection is active. You can still make or receive calls, but the data transmission is automatically interrupted.

My smartphone won't connect to the Internet

Your smartphone supports GPRS or UMTS (3G or HSDPA) wireless data networks. To connect to the Internet, you must subscribe to data services with your wireless service provider.

- Contact your wireless service provider to verify that your subscription plan includes data services and that these services have been correctly activated. Your wireless service provider should also be able to tell you if there are any outages in your location.
- Press and hold **Power**  to turn off your phone, then press and hold the same button to turn it back on.
- Perform a soft reset (see [Performing a soft reset](#)).
- Confirm that data services are correctly configured on your smartphone by doing the following:
 - 1 Press **Start**  and select **Settings**.
 - 2 Select the **Connections** tab, and then select **Connections** .
 - 3 On the Tasks tab, select **Manage existing connections**.
 - 4 If your wireless service provider's name appears in the list, press **OK** . If not, contact your wireless service provider for assistance.

I can't send or receive text or multimedia messages

- Make sure your phone is on and that you're inside a coverage area (see [Turning your phone on](#)).
- Contact your wireless service provider to verify that your plan includes messaging services, that these services have been correctly activated, and that they are available at your location. Your wireless service provider should be able to tell you if messaging services have been experiencing transmission delays.
- If possible, contact the recipient or sender of the message, and make sure the receiving device can handle the type of message you're sending.
- If a text message arrives but does not display a notification, perform a soft reset (see [Performing a soft reset](#)).

I can't make or receive calls using a hands-free device with Bluetooth® wireless technology

Verify all of the following:

- The **Turn on Bluetooth** box is checked in Bluetooth Settings.



- Your Bluetooth device is charged and turned on.
- Your smartphone is within range of the hands-free device. Bluetooth range is up to 10 meters (30 feet) in optimum environmental conditions, which include the absence of the following: obstacles, radio interference from nearby electronic equipment, and other factors.
- The Bluetooth Settings screen is closed.
- You are away from other devices using the 2.4 GHz radio frequency, such as cordless phones, microwaves, and Wi-Fi equipment. If this is impossible, move the phone closer to the hands-free device.
- The device specifications are compatible with your smartphone.

I lost the connection between my smartphone and my Bluetooth headset

- 1 Press **Start**  and select **Settings**.
- 2 Select the **Connections** tab, and then select **Bluetooth**.
- 3 Select the **Devices** tab.
- 4 Select your headset name from the list.

- 5 In **Partnership Settings**, make sure the **Hands Free** box is checked.
- 6 Select **Save**.
- 7 Highlight the headset name.
- 8 Press and hold **Center**  to open the shortcut menu and select **Set as Hands-Free**.
- 9 Test your headset by making or receiving a call.

If the headset still doesn't work, delete the existing partnership and create a new one. To delete the partnership:

- 1 Press **Start**  and select **Settings**.
- 2 Select the **Connections** tab, and then select **Bluetooth**.
- 3 Highlight the headset device name.
- 4 Press and hold **Center**  to open the shortcut menu and select **Delete**.
- 5 Create a new partnership (see [Connecting to devices with Bluetooth® wireless technology](#)).

Synchronization

Synchronization enables you to back up the information on your smartphone onto your computer or your server. If you ever need to perform a hard reset or otherwise erase all your information on your smartphone, you can synchronize your smartphone with your computer to restore the info. To make sure you always have an up-to-date backup of your info, synchronize frequently.

You can synchronize email and other information directly with Microsoft Exchange Server 2007 or Exchange Server 2003 with Service Pack 2 using Microsoft Exchange ActiveSync®, or you can synchronize your smartphone with your computer, using the desktop sync software that came with your smartphone.

DID YOU KNOW? You can go to the Windows Mobile website for more information at windowsmobile.com.

DID YOU KNOW? A common cause of sync problems is the presence of protective software, such as VPNs or firewalls, on your computer or network.



Desktop sync software

This section covers issues with synchronizing using the desktop sync software that came with your smartphone. If you have a Windows XP computer, the desktop sync software is called ActiveSync® desktop software. If you have a Windows Vista computer, the desktop sync software is called Windows Mobile Device Center.

NOTE See [Exchange ActiveSync \(wireless synchronization\)](#) for help with direct wireless synchronization with an Exchange server.

My smartphone does not sync when I connect it to my computer with the USB cable. Instead, I see a Treo Setup screen.



Your connection did not automatically switch to sync mode. Follow these steps to switch modes manually.

- 1 On your smartphone, press **Start**  and select **Settings**.
- 2 Select the **System** tab, and then select **PC Setup** .
- 3 Select **Synchronize**.

- 4 If you still cannot synchronize, go to palm.com/treoproumts-support for synchronization support.

I am in sync mode, but synchronization isn't working.



Even if you are in sync mode, synchronization cannot take place unless you have the desktop sync software installed on your computer. If you did not install the software during initial setup but want to synchronize, switch to setup mode so that you can install the software.

- 1 On your smartphone, press **Start**  and select **Settings**.
- 2 Select the **System** tab, and then select **PC Setup** .
- 3 Select **Set up my PC**.
- 4 If you still cannot synchronize, go to palm.com/treoproumts-support for synchronization support.



The desktop sync software does not respond to sync attempt

As you complete the following steps, synchronize after each step. If the

synchronization is successful, you do not need to complete the remaining steps.



- 1 Verify that the USB cable is securely connected at all points (see [Setting up your computer for synchronization](#)).
- 2 Make sure that all of the files you're trying to sync are closed on both your computer and your smartphone.
- 3 On a Windows XP computer, look for the ActiveSync  icon at the top of your smartphone screen and the ActiveSync  icon in the taskbar on your computer to make sure ActiveSync desktop software is running on your computer. On a Windows Vista computer, look for the **connection**  icon at the top of your smartphone screen.

If the correct icons are not displayed, do the following:

Smartphone: Press **Start** , select **Programs**, and select **ActiveSync** . Press **Menu** (right softkey) and select **Connections**. Make sure the **Synchronize all PCs using this connection** box is checked, and that **USB** is selected from the list.

Windows XP computer: Click **Start** > **Programs** > **Microsoft ActiveSync**.

Windows Vista computer: Click **Start** > **All Programs** > **Windows Mobile Device Center**.

- 4 Do one of the following:
 - Windows XP computer:** Double-click the **ActiveSync**  icon in your taskbar. From the **File** menu, select **Connection Settings**. Make sure the **Allow USB connections box** is checked and click **Connect**.
 - Windows Vista computer:** Click **Start** > **All Programs** > **Windows Mobile Device Center**. Select **Connect without setting up your device**, and then select **Connection settings**. Make sure the **Allow USB connections box** is checked and click **Connect**.
- 5 On your smartphone, press **Start** , select **Settings**, select the **Connections** tab, and then select **USB to PC** . If the **Enable advanced network functionality** box is checked, uncheck it. If this box is currently unchecked, then check it.

- 6 Perform a soft reset (see [Performing a soft reset](#)).
- 7 Restart your computer and make sure the desktop sync software is running.
- 8 If problems persist and you're synchronizing through a USB hub, try connecting the USB cable to a different USB port or directly to your computer's built-in USB port.
- 9 If you're already synchronizing through a built-in USB port on the front of your computer, move the USB cable to a USB on the back of your computer if your computer has USB ports in both places.
- 10 Uninstall the desktop software that came with your smartphone, and then repeat the installation process (see [Reinstalling the desktop software](#)).
- 11 For a Windows XP computer only, delete the existing partnership between your smartphone and your computer and create a new one by doing the following steps in turn:
 - Disconnect your smartphone and your computer from the USB cable.
 - Right-click the gray **ActiveSync**  icon in the taskbar in the lower-right corner of your computer screen and select **Open Microsoft ActiveSync**.
 - Click **File**, and then click **Delete Mobile Device**. When asked to confirm, click **Yes**.
 - Connect your smartphone and your computer to the USB cable.
 - When the Synchronization Setup Wizard appears, follow the steps to establish a sync relationship between your smartphone and your computer.
- 12 If your organization uses a firewall or a VPN connection, synchronizing with ActiveSync may not work. For a Windows XP computer only, go to microsoft.com and search for the following topics to help with specific firewall setup situations:
 - ActiveSync USB Connection Troubleshooting Guide
 - ActiveSync with Sygate Personal Firewall
 - ActiveSync with TrendMicro PC-cillin Internet Security

- ActiveSync with Norton Personal Firewall
- ActiveSync with Zone Alarm Security Suite
- ActiveSync with McAfee Personal Firewall
- ActiveSync with Windows Firewall

13 Verify with your computer hardware vendor that your operating system supports your internal USB controller.

Synchronization finishes but info doesn't appear where it should

- With the included desktop sync software, your smartphone can synchronize with the root folders of Microsoft Office Outlook Contacts, Calendar, Tasks, and Notes (Outlook sold separately; a free trial version is available for download from your smartphone). If you want to synchronize with a global Exchange Address Book, you must copy the addresses to your local Contacts list in Microsoft Office Outlook (right-click the addresses and select **Add to Personal Address Book**).

- Microsoft Office Outlook subfolders and public folders are not accessible with the included software. You may want to use a third-party solution instead.
- If you're trying to sync offline, be sure to set your Microsoft Office Outlook Calendar, Contacts, Notes, and Tasks to be available offline
- For music files, update the library in Windows Media Player Mobile (see [Working with libraries](#)).
- For pictures and videos, see [Synchronizing your pictures, videos, and music](#) for information on the location of synchronized items.
- For Office Mobile files, see [Where are the changes I made to my file?](#) for information on the location of synchronized files.
- If you're still having problems, try the following:
 - 1** Make sure you're synchronizing with the intended desktop personal information manager (PIM). The desktop sync software lets you synchronize with Microsoft Office Outlook for Windows. If you use a

different PIM, you need to install third-party software to synchronize. For more information, consult the company that makes the PIM.

- 2 Open the desktop sync software on your computer, and make sure the Files synchronization option is selected (see [Changing which applications sync](#)).
- 3 Uninstall the desktop sync software, reboot your computer, and then repeat the installation process (see [Reinstalling the desktop software](#)).

Synchronization starts but doesn't finish

Make sure that you installed the desktop software that came with your smartphone. If you're not sure whether this software is installed, reinstall it (see [Reinstalling the desktop software](#)).

My video and music files won't sync

- 1 Make sure you have Windows Media Player 10 or later installed on your computer.
- 2 Reinstall the desktop sync software (see [Reinstalling the desktop software](#)).
Media file synchronization fails if you installed the desktop sync software

before you installed Windows Media Player.



My appointments show up in the wrong time slot after I sync

- 1 Make sure that you installed the desktop sync software that came with your smartphone. If you're not sure whether this software is installed, reinstall it (see [Reinstalling the desktop software](#)).
- 2 Open Microsoft Office Outlook and correct the wrong entries.
- 3 Manually enter any information you added to your smartphone since the last time you synchronized.
- 4 Synchronize your smartphone and your computer.

My scheduled sync doesn't work

By default, a scheduled sync does not work while you are roaming. This is to prevent roaming charges on your account. If roaming charges are not a concern, follow these steps to continue your sync schedule while roaming:

- 1 Press **Start**  and select **Programs**.

- 2 Select **ActiveSync** .
- 3 Press **Menu** (right softkey) and select **Schedule**.
- 4 Check the **Use above setting when roaming** box.
- 5 Press **OK** .

An alert tells me that ActiveSync encountered a problem on the server

There is a temporary problem with the server or the server may be temporarily overloaded. Try again later. If the problem persists, contact your system administrator.

An alert tells me that there is not enough free memory to sync my info

The ActiveSync application on your smartphone ran out of storage space. Try the following:

- 1 Go to Memory Settings and close all running programs (see [Closing applications](#)).
- 2 If the problem persists, see [Making room on your smartphone](#) for suggestions on other ways to free up space on your smartphone.

An alert tells me that ActiveSync encountered a problem with [item type] [item name]

An error occurred during the sync of a single item. This error can usually be corrected only by removing the item that caused the error. If you sync again to see if the error persists, be aware that items causing this type of error are skipped and do not show up again.

My Today screen settings are not restored after a hard reset

Settings such as the background image and plug-in choices are not backed up during synchronization, so they can't be restored after a hard reset. If you use a backup utility, you may be able to restore a backup to recover your Today screen settings and other additional info.

Exchange ActiveSync (wireless synchronization)

This section covers issues with direct wireless synchronization with an Exchange server. See [Desktop sync software](#) for help with synchronizing using your desktop sync software.

TIP If you are synchronizing with an Exchange server and you're unable to change your lock settings, check with your system administrator to find out if a systemwide locking policy is in place.

An alert tells me that the server could not be reached

Your smartphone had to wait too long to connect to the Exchange server. The connection may have been lost, the server may be temporarily overloaded, or the server may have encountered an internal error. Check your Exchange server name and proxy server settings (see [Setting up wireless synchronization](#)), and try again later.

An alert tells me that my account information could not be detected

When you set up the Exchange server sync options, the credentials page was left blank. Correct the credentials (see [Setting up wireless synchronization](#)), or set up your smartphone to sync only with a computer, and try to sync again.

An alert tells me the device timed out while waiting for credentials

The Exchange server credentials screen was left open too long. Re-enter the Exchange server credentials, and try to sync again.

Email

I have problems using my account

Occasionally you may experience problems using an email account after you set it up. If you followed the account setup procedure and are experiencing problems in using the account, verify that the account complies with your email provider's requirements by following these steps:

- Verify both your password and your username for your email account.
- Some email service providers require you to be on their network to use your email account. If this is the case, be sure to use your provider's network as the connection type for the account.
- Some email service providers have other requirements specific to their

service. Check with your service provider to see if any provider-specific requirements exist.

- Service provider settings frequently change. If your email account was working but you are currently experiencing problems, check with your service provider to see if any of the account settings have changed.

I have problems sending and receiving email



Short periods of time when email is unavailable are common due to server problems or poor wireless coverage. If you have problems sending or receiving mail for an extended period of time, check with your ISP or email service provider to verify that the service is working properly.

Scheduled email synchronization is not working

If email synchronization is occurring and you turn your smartphone off or the connection to your email service provider is disconnected, the synchronization fails.



- Check the synchronization schedule to make sure that email sync is set to

occur at the expected day and time. See [Setting the synchronization schedule](#) for details.

- Press **Start** , select **Programs**, and then select **ActiveSync** . Press **Menu** (right softkey) and select **Configure Server**. Make sure the verify password setting is on. This is required for over-the-air synchronization.

I have problems sending email

If you are able to receive email messages but cannot send them, try the following steps, in turn:

- Make sure your ISP or email provider allows you to access email on a smartphone. Some providers do not offer this option at all; other providers require an upgrade for accessing email on a smartphone.
- Press **Start** , select **Programs**, and then select **ActiveSync** . Press **Menu** (right softkey) and select **Configure Server**. Make sure the **SSL** box is checked.
- Enter the name of a different outgoing mail server for sending mail. Many ISPs,

such as cable companies, require that you have an Internet connection to their network to send email through their servers. In this case, you can almost always receive email from these accounts, but if you want to send email, you must send it through another server (see [Setting up a POP/IMAP account in the Messaging application: Common email providers](#)).

My vCard or vCal email attachment isn't forwarding correctly



Microsoft Office Outlook provides several features including vCard and vCal that work with email client software on a Windows computer. For these features to work correctly, the email client software must be properly set up. Follow these steps to check the settings:

- 1 Click **Start** on your computer and select **Settings**.
- 2 Select **Internet Options** and click the **Programs** tab.
- 3 Make sure that the email field is set to the correct email client software.

- 4 Click **OK**.
- 5 Start the email client software and make sure it is configured as the default MAPI client. Consult the documentation for your desktop email application for more information.

When I sync with my Exchange server my info is not downloading to my smartphone

Check with your system administrator to obtain the name of the mail server that offers you wireless access to the corporate mail system. If you cannot obtain the name of this server (some companies do not give it out, because they do not want wireless access to their servers), you cannot use Exchange ActiveSync to synchronize with the Exchange server. You can also check the following setting:

- 1 Press **Start**  and select **Programs**.
- 2 Select **ActiveSync** .
- 3 Press **Menu** (right softkey) and select **Configure Server**.
- 4 Make sure the **SSL** box is checked.

Web

I can't access a web page

First, make sure you have Internet access: Open Internet Explorer Mobile and try to view a web page you've loaded before. To ensure that you're viewing the page directly from the Internet, press **Menu** (right softkey) and select **Refresh**. After confirming your Internet connection, try to view the page in question again. If it comes up blank, press **Menu** (right softkey) and select **Refresh**.

If you're still having trouble, the page may contain elements that are not supported by Internet Explorer Mobile, such as Flash, Shockwave, VBScript, WML script, and other plug-ins.

Some websites use a redirector to their true home page. For example, if you enter the address <http://palm.com/support>, it may resolve to <http://palm.com/us/support>. If Internet Explorer Mobile can't follow the redirect, try using a desktop browser to see the landing page of the redirector, and enter that address in Internet Explorer Mobile.

TIP Your smartphone can open your email application when you select an email address on a web page. If nothing happens when you select the link, try setting up your email application first.

An image or map is too small on my smartphone screen

Internet Explorer Mobile has several viewing modes: One Column, Default, Desktop, and Full Screen. Switch to Desktop to see the full-size image (see [Viewing a web page](#)).

A secure site refuses to permit a transaction

Some websites don't support certain browsers for transactions. Please contact the site's webmaster to make sure the site allows transactions using Internet Explorer Mobile.

Camera

DID YOU KNOW? Pictures are 16-bit color. Resolution settings range from the low end of VGA (160 x 120 pixels) to a high end of 2 megapixels (1600 x 1200). Video resolution settings range from a low end of 176 x 144 pixels to a high end of 352 x 288 pixels. You can change the resolution setting by pressing **Menu** (right softkey) and selecting **Resolution** (still images) or **Quality** (video).

Here are some tips for taking good pictures with the built-in camera:

- Clean the camera's lens with a soft, lint-free cloth.
- Take pictures in bright lighting conditions. Low-light images may be grainy, due to the sensitivity of the camera.
- Hold the camera as still as possible. Try supporting your picture-taking arm against your body or a stationary object (such as a wall).
- Keep the subject of the pictures still. Exposure time is longer with lower light levels, so you may see a blur.

- For best results, verify that you have the brightest light source coming from behind you, lighting the subject's face. Avoid taking indoor pictures with the subject in front of a window or light.
- Make sure the subject is at least 0.5 meters (18 inches) away from the camera to ensure good focus.

When you synchronize with a Windows XP computer, your Camera images are stored in the C:\Documents and Settings\\My Documents\Treo My Documents folder on your hard drive (see [Camera](#)).

The Camera preview image looks strange

Some third-party applications overwrite the color settings on your smartphone with their own 8-bit color settings. This can affect the Camera Preview Mode. Delete third-party applications one by one until the preview image improves (see [Removing applications](#)).

Third-party applications

Sometimes third-party applications can cause conflicts on your smartphone. Third-party applications that modify wireless features may affect the performance of your smartphone and may require extra troubleshooting. Use caution when installing the following types of applications:

- Ringtone managers
- Caller ID applications
- Instant messaging
- Applications that modify when your phone or data connections turn on or off and how your phone behaves

If you recently installed an application and your smartphone seems to be stuck, try the following:

- 1 Perform a soft reset (see [Performing a soft reset](#)).
- 2 Make sure the third-party application is compatible with the Windows Mobile 6.1 Professional operating system on your smartphone.
- 3 Delete the most recently installed application from your smartphone (see [Removing applications](#)).
- 4 If the problem persists, perform another soft reset.
- 5 If possible, synchronize or use a backup utility to back up your most recent info.
- 6 Perform a hard reset (see [Performing a hard reset](#)).
- 7 Synchronize or restore your backup to restore the info in your built-in applications.
- 8 If the problem is resolved, begin reinstalling your third-party applications one at a time.
- 9 If the problem recurs, delete the last application you installed and report the problem to its developer.

Getting more help

Contact the vendor of any third-party software if you require further assistance.

TIP Remember that not all third-party applications were written with the Treo Pro smartphone keyboard and 5-way navigator in mind. You may encounter strange behavior or errors in these applications if you use the keyboard and the 5-way navigator.

Making room on your smartphone

If you store a large amount of information, or install many third-party applications, the internal memory on your smartphone may fill up. Here are some common ways to clear space on your smartphone:

Camera: Large images or videos take up a lot of memory. Move images to an expansion card or delete images from your smartphone (see [Pictures & Videos](#)).

Messaging: Multimedia content and email attachments can consume excessive memory. Move multimedia content and attachments to an expansion card, or delete large files from your smartphone (see [Deleting messages](#) and [Deleting](#)

[messages](#)). You may also want to empty the deleted items folder.

Internet: If you save links to pages you've visited in Internet Explorer Mobile, you may want to clear all recent pages (see [Customizing your Internet Explorer Mobile settings](#)).

Third-party applications: You can delete infrequently used applications or move them to an expansion card (see [Moving info between your smartphone and an expansion card using File Explorer](#)).

Also, remember that your smartphone includes an expansion card slot, and that you can store applications and information on expansion cards. However, you still need free memory on the smartphone itself to run applications from an expansion card.

Voice quality

Is the other person hearing an echo?

- Try decreasing the volume on your smartphone to avoid coupling

or feedback on the other person's end. This applies to both the speakerphone and to the handset earpiece.

- Position the smartphone closer to your ear to prevent sound leaking back to the microphone. Keep your hand away from the microphone hole, which is on the lower-right side of your smartphone.
- If you're using Speakerphone mode with your smartphone lying on a flat surface, try turning the smartphone "face down" (screen facing the surface).

Are you hearing your own voice echo?

Ask the other person to turn down their volume or to hold the phone closer to their ear.

Is your voice too quiet on the other end?

Be sure to hold the bottom of the smartphone, or the hands-free microphone, close to your mouth.

Check the signal strength indicator. If the signal is weak, try to find an area with better coverage.

Terms

ActiveSync®

The software on your smartphone that exchanges and updates the information on your Palm® Treo™ Pro smartphone with the information on your computer.

ActiveSync desktop software

The software on your Windows XP computer that exchanges and updates the information on your computer with the information on your smartphone. To open ActiveSync on your computer, double-click the ActiveSync icon in the taskbar in the lower-right corner of your screen. If the icon does not appear, click **Start > All Programs** (or navigate to the **Programs** group) > **Microsoft ActiveSync**. See [Installing the desktop sync software](#).

auto-off interval

The time of inactivity that passes before the screen on your smartphone turns off. The wireless features on your smartphone are unaffected by this setting. See [Optimizing power settings](#).

beam

The process of sending or receiving an entry or application using the infrared (IR) port on your smartphone or using Bluetooth® wireless technology. See [Beaming information](#).

Bluetooth® wireless technology

Technology that enables devices such as smartphones, mobile phones, and computers to connect wirelessly to each other so that they can exchange information over short distances. For more info, visit bluetooth.com. See [Connecting to devices with Bluetooth® wireless technology](#).

desktop software

A Personal Information Manager (PIM) application for computers, such as Microsoft Outlook®, that helps you manage your personal information and keep it synchronized with your smartphone. See [Installing the desktop sync software](#).

dialog box

A set of options and command buttons that is enclosed by a border and that enables you to carry out a specific task.

EDGE (Enhanced Data rates for GSM Evolution)

An enhanced version of GPRS that delivers data speeds that are up to 3 times faster than standard GPRS connections, with rates up to 236.8 Kbps. (Additional charges may apply.) See [What are all those icons?](#)

EXIF (Exchangeable Image File Format)

A standard for storing interchange information in image files that enables images to be interoperable across multiple devices.

GPRS (General Packet Radio Service)

A mobile Internet connectivity technology that allows persistent data connections. (Additional charges may apply.) See [What are all those icons?](#)

HSDPA (High-Speed Download Packet Access)

An evolutionary enhancement to UMTS packet data. HSDPA uses different modulation and coding techniques to improve downlink performance. Your smartphone supports data rates up to 700Kbps.

infrared (IR)

A way of transmitting information using light waves. You use the IR port on your smartphone to transfer information between other IR devices within a short radius. See [Beaming information](#).

Lithium-ion (Li-ion)

The rechargeable battery technology used in your smartphone. See [Charging the battery](#).

Microsoft Exchange ActiveSync®

Technology that allows your smartphone to synchronize email, contacts, calendar events, and tasks wirelessly with Microsoft Exchange Server 2003 or 2007. See [Setting up wireless synchronization](#).

MMS (Multimedia Messaging System)

An enhanced messaging system that enables you to send pictures, animations, and ringtones almost instantly. See [Creating and sending a multimedia message](#).

Mobile Device

The component on your Windows XP computer that enables you to install applications and other information on your

smartphone. To access it, open Windows Explorer or My Computer and look for the icon that represents your smartphone. See [Installing applications from your computer](#).

partnership

The connection that you make between two devices by means of Bluetooth wireless technology. The devices recognize each other because each device finds the same passkey on the other device. After you create a partnership between the devices, you no longer need to enter the passkey. Partnership is also known as *paired relationship*, *pairing*, *trusted device*, and *trusted pair* on some devices. See [Connecting to devices with Bluetooth® wireless technology](#).

Phone Off

Appearing on the Today screen, this indicates that your smartphone is not connected to any network, and you cannot make calls except those to emergency numbers. You can still use the organizer features, however. See [Turning your phone on](#).

piconet

An ad-hoc network of devices that uses Bluetooth wireless technology to connect one master device with up to seven active slave devices. The network can include up to 255 inactive, or parked, slave devices which the master device can bring into active status at any time.

PIM (personal information manager)

A genre of software that includes applications such as Microsoft Outlook, Palm® Desktop software, Lotus Notes, and ACT!. PIMs generally store contacts, schedules, tasks, and memos.

PIN (personal identification number)

The password assigned to your SIM card by your wireless service provider. Turning on the PIN lock secures your wireless account. See also PUK. See [Locking the SIM card](#).

PIN2 (personal identification number 2)

A code that protects certain network settings such as fixed dialing. See [Enabling fixed dialing](#).

PUK (personal unblocking key)

A special extended password assigned to your SIM card. If you enter the wrong PIN more than the allowed number of times, your SIM is blocked and you must call your wireless service provider for the PUK. See [Locking the SIM card](#).

PUK2 (personal unblocking key 2)

A special extended password assigned to your SIM card, specific to certain network features such as fixed dialing. If you enter the wrong PIN2 more than the allowed number of times, your SIM is blocked and you must call your wireless service provider for the PUK2. See [Enabling fixed dialing](#).

Secure Sockets Layer (SSL)

A security protocol that enables you to send personal information in a more secure manner over the Internet.

SIM (Subscriber Identity Module) card

The smartcard, inserted into your smartphone, that contains your mobile account information, such as your phone number and the services to which you subscribe. You can also store addresses,

phone numbers, and SMS messages on the SIM card. See [Inserting the SIM card and battery](#).

SMS (Short Messaging Service)

The service that exchanges short text messages almost instantly between mobile devices. Your smartphone can send and receive text messages while you are on a call. See [Creating and sending a text message](#).

streaming

Technology that enables you to access media content—for example, watch video or listen to an audio program—directly from the Internet on your smartphone without needing to download and save a file on your smartphone. See [Viewing a video](#).

synchronization

The process in which information that is entered or updated on your smartphone, your computer, or a server is automatically updated in one of the other locations either wirelessly or by means of a cable connection. See [Synchronizing information](#).

UMTS (Universal Mobile Telecommunications System)

One of the third-generation (3G) mobile phone technologies that is designed for high-speed data transfer, with rates up to 384 Kbps, as well as voice and multimedia services. It uses W-CDMA as the underlying technology. See [What are all those icons?](#)

username

The name associated with your smartphone that distinguishes it from other Windows Mobile® devices. If you install desktop software, you are asked to give your smartphone a username. If you only synchronize wirelessly using Microsoft Exchange ActiveSync, you do not need to give your smartphone a username. See [Installing the desktop sync software.](#)

Windows Mobile

The operating system of your Treo Pro smartphone. Your smartphone uses Windows Mobile® 6 Professional edition. When installing third-party applications to your smartphone, be sure to install only apps that are written for Microsoft Windows Mobile 6.1 Professional. Apps designed for Microsoft Windows Mobile 6.1 Standard or any edition of Windows Mobile 5.0 software are not compatible with your Treo Pro smartphone. See [Installing third-party applications.](#)

Windows Mobile Device Center

The software on your Windows Vista computer that enables you to synchronize content and manage music, pictures, and videos between your smartphone and your computer. To open Windows Mobile Device Center on your computer, click **Start > All Programs > Windows Mobile Device Center.**

Regulatory and safety information

NOTE To see your End User License Agreement, go to your *General User Guide: Important Safety and Legal Information* booklet included with your device.



Do not use hand-held while driving



For body-worn operation maintain a separation of 1.5 cm



Small parts may cause a choking hazard



This device may produce a loud sound



Keep away from pacemakers and other personal medical devices



Switch off when instructed in hospitals and medical facilities



Switch off when instructed in aircrafts and airports



Switch off in explosive environments



Do not use while re-fuelling



This device may produce a bright or flashing light



Do not dispose of in a fire



Avoid contact with magnetic media



Avoid Extreme Temperatures



Avoid contact with liquid, keep dry



Do not try and disassemble



Do not rely on this device for emergency communications



Only use approved accessories

FCC Statements

This equipment has been tested and found to comply with the limits for a Class B digital device, pursuant to part 15 of the FCC Rules. These limits are designed to provide reasonable protection against harmful interference in a residential installation. This equipment generates, uses and can radiate radio frequency energy and, if not installed and used in accordance with the instructions, may cause harmful interference to radio communications. However, there is no guarantee that interference will not occur in a particular installation. If this equipment does cause harmful interference to radio or television reception, which can be determined by turning the equipment off and on, the user is encouraged to try to correct the interference by one or more of the following measures:

- Reorient or relocate the receiving antenna.
- Increase the separation between the equipment and receiver.
- Connect the equipment into an outlet on a circuit different from that to which the receiver is connected.
- Consult the dealer or an experienced radio/TV technician for help.

This device complies with Part 15 of the FCC Rules. Operation is subject to the following two conditions: (1) this device may not cause harmful interference, and (2) this device must accept any interference received, including interference that may cause undesired operation.

This phone meets the FCC Radiofrequency Emission Guidelines and is certified with the FCC as:

FCC ID: O8F-SKYG.

The FCC ID on your Palm smartphone is located on a label inside the battery compartment. The battery must be removed as shown below to view the label.



CAUTION Changes or modifications not expressly approved by the party responsible for compliance could void the user's authority to operate the equipment.

Antenna Care/Unauthorized Modifications

Use only the supplied integral antenna. Unauthorized antenna modifications or attachments could damage the unit and may violate FCC regulations.

Industry Canada

Operation is subject to the following two conditions: (1) this device may not cause harmful interference, and (2) this device must accept any interference received, including interference that may cause undesired operation.

The term "IC" before the equipment certification number only signifies that the Industry Canada technical specifications were met.

IC: 3905A-SKYG

This Class B digital apparatus complies with Canadian ICES-003.

L' utilisation de ce dispositif est autorisée seulement aux conditions suivantes : (1) il ne doit pas produire de brouillage et (2) l' utilisateur du dispositif doit être prêt à accepter tout brouillage radioélectrique reçu, même si ce brouillage est susceptible de compromettre le fonctionnement du dispositif. Cet appareil numérique de la classe [*] est conforme à la norme NMB-003 du Canada.

EU Regulatory Conformance

We, Palm, Inc. hereby declare that this device is in conformance to all essential requirements of the R&TTE Directive 1999/5/EC.

This equipment is marked with the



symbol and can be used throughout the European community.

This indicates compliance with the R&TTE Directive 1999/5/EC and meets the relevant parts of following technical specifications:

- ETSI EN 301 511

- ETSI EN 301 908-1
- ETSI EN 301 908-2
- ETSI EN 300 328
- ETSI EN 301 489-1/-7/-17/-24
- EN 60950-1
- EN 50360
- EN 50371

Marking by the symbol  indicates this equipment uses non-harmonized frequency bands.

France—2.4GHz for Metropolitan France:

In all Metropolitan departments, wireless LAN frequencies can be used under the following conditions, either for public or private use:

- Indoor use: maximum power (EIRP*) of 100 mW for the entire 2400–2483.5 MHz frequency band
- Outdoor use: maximum power (EIRP*) of 100 mW for the 2400–2454 MHz band and with maximum power (EIRP*) of 10 mW for the 2454–2483 MHz band

Responsible party

(North America)
Palm Inc.
950 W. Maude Ave.
Sunnyvale, CA 95085
USA
www.palm.com

(Europe)
Palm Europe Ltd.*
Roy Bedlow
Buckhurst Court
London Road, Wokingham
Berkshire RG40 1PA,
UK

RF Safety Exposure

General statement on RF energy: Your smartphone contains a transmitter and a receiver. When it is ON, it receives and transmits RF energy. When you communicate with your smartphone, the system handling your call controls the power level at which your smartphone transmits.

Specific Absorption Rate (SAR): Your mobile device is a radio transmitter and receiver. It is designed not to exceed the limits for exposure to radio waves recommended by international guidelines. These guidelines were developed by the independent scientific organization ICNIRP and include safety margins designed to assure the protection of all persons, regardless of age and health.

In order to certify this unit for sale in the US, Canada and Europe this unit has been tested for RF exposure compliance at a qualified test laboratory and found to comply with the regulations regarding exposure to RF Energy under the recommendations of the International Commission on Non-ionizing Radiation Protection (ICNIRP). The tests are performed in positions and locations as required by the FCC, IC, and The Council of the European Union for each model.

As SAR is measured utilising the device's highest transmitting power, the actual SAR of this device while operating is typically below that indicated below. This is due to automatic changes to the power level of the device to ensure it only uses the minimum power required to communicate with the network.

The SAR limit for mobile devices set by FCC/IC is 1.6 W/kg averaged over 1 gram of tissue for the body or head (4.0 W/kg averaged over 10 grams of tissue for the extremities—hands, wrists, ankles, and feet).

The highest reported SAR values of the Palm smartphone are:

Maximum 1g SAR values (FCC)				
	GSM850	GSM1900	WCDMA 850	WCDMA 1900
Head SAR	0.775 W/kg	0.602 W/kg	0.7 W/kg	1.5 W/kg
Body SAR	1.25 W/kg	0.527 W/kg	0.687 W/kg	0.608 W/kg

The SAR limit recommended by The Council of the European Union is 2.0 W/kg averaged over 10 grams of tissue for the body or head (4.0 W/kg averaged over 10 grams of tissue for the extremities—hands, wrists, ankles, and feet).

Maximum 10g SAR values (CE)			
	GSM900	GSM1800	WCDMA2100
Head SAR	0.75 W/kg	0.788 W/kg	0.964 W/kg
Body SAR	0.866 W/kg	0.8 W/kg	0.332 W/kg

In order to comply with FCC, IC and EU RF exposure safety guidelines, users MUST use one of the following types of body worn accessories:

- 1 A Palm® brand body-worn accessory that has been tested for (specific absorption rate) SAR compliance and is intended for use with this product.
- 2 An accessory that contains NO metal (snaps, clips, etc.) and provides AT LEAST 1.5 cm (0.6 in.) of separation between the user's body and the unit.

Do NOT use the device in a manner such that it is in direct contact with the body (i. e. on the lap or in a breast pocket). Such use will likely exceed the FCC RF safety exposure limits. See www.fcc.gov/oet/rfsafety for more information on RF exposure safety.

To view the most recent SAR values of the Treo Pro smartphone, visit palm.com/23058.

Body worn operation: Important safety information regarding radio frequency radiation (RF) exposure: To ensure compliance with RF exposure guidelines the smartphone must be used with a minimum of 1.5 cm (0.6 in.) separation from the body. Failure to observe these instructions could result in your RF exposure exceeding the relevant guideline limits.

Limiting exposure to radio frequency (RF) fields: For individuals concerned about limiting their exposure to RF fields, the World Health Organisation (WHO) provides the following advice:

Precautionary measures: Present scientific information does not indicate the need for any special precautions for the use of mobile phones. If individuals are concerned, they might choose to limit their

own or their children's RF exposure by limiting the length of calls, or using 'hands-free' devices to keep mobile phones away from the head and body.

Further information on this subject can be obtained from the WHO home page <http://www.who.int/mediacentre/factsheets/fs193/en/index.html> WHO Fact sheet 193: June 2000.

Précautions d'usage de votre téléphone mobile

Le taux de DAS⁽¹⁾ (Débit d'Absorption Spécifique) de votre Treo Pro est 0.964 W/kg.:

Conseils d'utilisation pour réduire le niveau d'exposition aux rayonnements

Utiliser le plus souvent possible les kits piétons (oreillettes), notamment en cas d'usage fréquent ou prolongé du téléphone mobile. Ils apportent en outre un plus grand confort d'utilisation.

Eloigner le téléphone mobile de certaines zones sensibles telles que le ventre chez les femmes enceintes ou le bas-ventre chez les adolescents, plus particulièrement lors d'une communication.

Utiliser votre téléphone mobile dans de bonnes conditions de réception. Celle-ci est indiquée sur l'écran de votre téléphone par la matérialisation de barrettes. En présence de 3 ou 4 barrettes, la réception est de bonne qualité pour passer vos communications. Ce n'est pas toujours le cas dans certaines zones ou situations, notamment les parking souterrains, les ascenseurs, en train ou en voiture ou tout simplement dans un secteur mal couvert par le réseau.

Mesures touchant à la sécurité :

Dans certains lieux ou situations, tels que les avions, les hôpitaux, les stations-service et les garages professionnels, l'usage du téléphone est interdit. Il est donc impératif de respecter strictement les consignes de sécurité propres à chacune de ces situations et d'éteindre votre téléphone lorsque cela est requis.

Par ailleurs pour éviter les risques d'interférences, les personnes porteuses d'implants électroniques (stimulateurs cardiaques, pompes à insuline, neurostimulateurs...) doivent conserver une distance de 15 cm entre le mobile et l'implant et ne l'utiliser que du côté opposé au côté où celui-ci est situé.

Téléphoner en conduisant, même avec des équipements qui ne sont pas interdits par la réglementation, est dangereux car il augmente potentiellement le risque d'accident provenant de la distraction créée par la conversation elle-même. Aussi, est-il recommandé de ne jamais téléphoner en conduisant et de considérer que l'utilisation d'un kit mains-libres n'est pas une solution.

⁽¹⁾Valeur DAS la plus élevée pour ce modèle de téléphone et pour une utilisation à l'oreille, communiquée par le constructeur. Le DAS, exprimé en *w/kg*, quantifie le niveau d'exposition aux ondes électromagnétiques et permet de vérifier la conformité des mobiles à la réglementation française et européenne qui impose que celui-ci soit inférieur à 2*w/kg*.

Battery handling:

- Do not disassemble or open crush, bend or deform, puncture or shred.
- Do not modify or remanufacture, attempt to insert foreign objects into the battery, immerse or expose to water or other liquids, expose to fire, explosion or other hazard.
- Only use the battery for the system for which it is specified.
- Only use the battery with a charging system that has been qualified with the system per the IEEE/CTIA-1725 standard. Use of an unqualified battery or charger may present a risk of fire, explosion, leakage, or other hazard.
- Do not short circuit a battery or allow metallic conductive objects to contact battery terminals.
- Replace the battery only with another battery that has been qualified with the system per IEEE/CTIA-1725. Use of an unqualified battery may present a risk of fire, explosion, leakage or other hazard.
- Promptly dispose of used batteries in accordance with local regulations.

- Battery usage by children should be supervised.
- Avoid dropping the phone or battery. If the phone or battery is dropped, especially on a hard surface, and the user suspects damage, take it to a service center for inspection.
- Do not handle a damaged or leaking Lithium-Ion (L-Ion) battery as you can be burned.
- Improper battery use may result in a fire, explosion or other hazard.

Based on DOT rules, spare batteries must not be transported in checked luggage on commercial flights. Spare batteries can only be transported in carry-on luggage. For more information: http://safetravel.dot.gov/whats_new_batteries.html.

Protecting Your Battery

The guidelines listed below help you get the most out of your battery's performance.

Recently there have been some public reports of wireless phone batteries overheating, catching fire, or exploding. It appears that many, if not all, of these reports involve counterfeit or inexpensive, aftermarket-brand batteries with unknown or questionable manufacturing standards. Use only manufacturer-approved batteries and accessories found at Carrier Stores or through your device's manufacturer. Buying the right batteries and accessories is the best way to ensure they're genuine and safe.

- In order to avoid damage, charge the battery only in temperatures that range from 32° F to 122° F (0° C to 50° C).
- Don't use the battery charger in direct sunlight or in high humidity areas, such as the bathroom.
- Never dispose of the battery by incineration.
- Keep the metal contacts on top of the battery clean.
- Don't attempt to disassemble or short-circuit the battery.
- The battery may need recharging if it has not been used for a long period of time.

- It's best to replace the battery when it no longer provides acceptable performance. It can be recharged hundreds of times before it needs replacing
- Don't store the battery in high temperature areas for long periods of time. It's best to follow these storage rules:
 - Less than one month: -4° F to 140° F (-20° C to 60° C)
 - More than one month: -4° F to 113° F (-20° C to 45° C)

Power Specifications

Use only Palm-approved power accessories such as AC-power adapters and batteries. Unauthorized and non-approved batteries will NOT operate with the Palm product.

AC Power Adapter source: Helmsman

Model: PMG0501000P

Part Number: 157-10107-00

Input Rating: 100–240 Vac, 50/60Hz, 0.3A

Output Rating: 5Vdc, 1000mA

AC Power Adapter source: Foxlink

Model: 5890-712V-02K0

Part Number: 157-10108-00

Input Rating: 100–240 Vac, 50/60Hz, 0.25A

Output Rating: 5Vdc, 1000mA

Battery Source: Palm

Type: Rechargeable Li-Ion Polymer

Model: 157-10105-00

Rating: 3.7Vdc, 1500mAh (minimum)

Recycling and Disposal



This symbol indicates that Palm products should be recycled and not be disposed of in unsorted Municipal waste. Palm products should be sent to a facility that properly recycles electrical and electronic equipment.

For information on Palm's environmental programs, visit www.palm.com/environment.

As part of Palm's corporate commitment to be a good steward of the environment, we strive to use environmentally friendly materials, reduce waste, and develop the highest standards in electronics

recycling. Our recycling program keeps Palm handheld devices, smartphones and mobile companions out of landfills through evaluation and disposition for reuse and recycling.

Palm customers may participate in the recycling program free of charge. Visit www.palm.com/recycle for additional details and information about how you can help reduce electronic waste.

Recycling and Disposal

Palm is committed to supporting the collection and recycling of its products. Palm participates and supports the WEEE directive in the European Union. For more information on the WEEE directive implementation in the various EU member states please see www.weee-forum.org.

Recyclage et mise au rebut (pour la France seulement)



Ce symbole indique que les produits Palm doivent être recyclés. Vous ne pouvez pas vous en débarrasser dans une déchèterie municipale n'effectuant pas le tri sélectif. Les produits Palm doivent être envoyés dans un centre prenant en charge le recyclage des appareils électriques et électroniques. Ce service est disponible gratuitement

dans votre commune.

En tant qu'utilisateur de cet appareil, vous êtes tenu de vous débarrasser de cet équipement électronique dans un centre de collecte agréé par votre commune. Pour en savoir plus sur le centre de collecte le plus proche, contactez votre commune. Si vous remplacez un ancien appareil par un nouveau produit équivalent, le distributeur est tenu de le reprendre gratuitement dans la mesure où l'appareil est de type équivalent et propose les mêmes fonctionnalités.

Les produits électroniques peuvent contenir des substances dangereuses potentiellement à risque pour la santé et l'environnement. Le recyclage est bon pour l'environnement. Il permet en effet de ne pas surcharger les décharges et de valoriser des matériaux pouvant être recyclés en d'autres produits. Le recyclage responsable garantit une collecte et une mise au rebut appropriées des matériaux. Palm s'engage à respecter la Directive

DEEE de l'Union européenne (2002/96/EC), applicable en France par le Décret n°2005-829 en date du 20 juillet 2005, et à protéger l'environnement pour les générations futures.

Il est de la responsabilité de chacun de s'assurer que les produits électriques et électroniques sont correctement réutilisés, recyclés ou revalorisés.

Pour plus d'informations: www.eco-systemes.com.

User Safety

Operational Warnings

IMPORTANT INFORMATION ON SAFE AND EFFICIENT OPERATION. Read this information before using your smartphone. For the safe and efficient operation of your smartphone, observe these guidelines.

Potentially explosive atmospheres: Turn off your smartphone when you are in any areas with a potentially explosive atmosphere, such as fueling areas (gas or petrol stations, below deck on boats) storage facilities for fuel or chemicals, blasting areas and areas near electrical blasting caps, and areas where there are chemicals or particles (such as metal powders, grains and dust) in the air.

Interference to medical and personal Electronic Devices: Most but not all electronic equipment is shielded from RF signals and certain electronic equipment may not be shielded against the RF signals from your smartphone.

Pacemakers: The Health Industry Manufacturers Association recommends that a minimum separation of 15 centimeters (6 inches) be maintained between a smartphone and a pacemaker to avoid potential interference with the pacemaker. These recommendations are consistent with the independent research by the recommendations of Wireless Technology Research.

Persons with pacemakers should:

- ALWAYS keep the smartphone more than six inches (15 centimeters) from their pacemaker when the smartphone is turned ON.
- Not carry the smartphone in a breast pocket.

- Use the ear opposite the pacemaker to minimise the potential for interference.
- Turn the smartphone OFF immediately if you have any reason to suspect that interference is taking place.

Other Medical Devices, Hospitals: If you use any other personal medical device, consult the manufacturer of your device to determine if it is adequately shielded from external RF energy. Your physician may be able to assist you in obtaining this information. Turn your smartphone OFF in health care facilities when any regulations posted in these areas instruct you to do so. Hospitals or health care facilities may be using equipment that could be sensitive to external RF energy.

Repetitive Motion Injuries: When using the keyboard or playing games on your smartphone, you may experience discomfort in your neck, shoulders, hands, arms, of other parts of the body. To avoid any injury, such as tendonitis, carpal tunnel syndrome, or other musculoskeletal disorder, make sure to take necessary breaks from use, take longer rests (such as several hours) if discomfort or tiring begins, and see a doctor if discomfort persists. To minimize the risk of Repetitive Motion Injuries, when Texting or playing games with your phone:

- Do not grip the phone too tightly
- Press the buttons lightly
- Make use of the special features in the handset which minimize the number of buttons which have to be pressed, such as message templates and predictive text
- Take lots of breaks to stretch and relax

Blackouts and Seizures: Blinking lights, such as those experienced with television or playing video games may cause some people to experience blackout or seizure, even if never experienced before. In the event a smartphone user should experience any disorientation, loss of awareness, convulsion, eye or muscle twitching or other involuntary movements, stop use immediately and consult a doctor. Individuals with personal or family history of such events should consult a doctor before using the device. To limit the possibility of such symptoms, wherever possible every hour take a minimum of 15 minutes, use in a well lighted area, view the screen from the farthest distance and avoid exposure to blinking lights if you are tired.

Operating Machinery: Do not use your smartphone while operating machinery. Full attention must be given to operating the machinery in order to reduce the risk of an accident.

Aircraft: While in aircraft, follow all instructions regarding the operation of your smartphone. Use of your smartphone while on board an aircraft must be done in accordance in compliance with airline instructions and regulations.

Vehicles with Air Bags: Your smartphone should not be placed in a position that would affect the operation of air bag deployment or in a position that, should the air bag inflate, could propel the smartphone. Air bags will inflate with great force and care should be taken to protect within a vehicle that has air bags. Do not place a phone in the area over an air bag or in the air bag deployment area. Store the phone safely before driving the vehicle.

Hearing Aids: People with hearing aids or other cochlear implants may experience interfering noises when using wireless devices or when one is nearby. The level of interference will depend on the type of hearing device and the distance from the interference source. Increasing the separation between them may reduce the interference. You may also consult your hearing aid manufacturer to discuss alternatives.

Small children: Do not leave your smartphone and its accessories within the reach of small children or allow them to play with it. They could hurt themselves or others, or could accidentally damage the smartphone. Your smartphone contains small parts with sharp edges that may cause an injury or which could become detached and create a choking hazard.

Keep the device away from the abdomens of pregnant women and adolescents, particularly when using the device hands-free.

To reduce exposure to radiation, use your device in good reception areas, as indicated by the bars on your phone, at least 3 to 4 bars.

CAUTION Avoid potential hearing loss.

Prolonged exposure to loud sounds (including music) is the most common cause of preventable hearing loss. Some scientific research suggests that using portable audio devices, such as portable music players and cellular telephones, at high volume settings for long durations may lead to permanent noise-induced hearing loss. This includes the use of headphones (including headsets, earbuds and

Bluetooth® or other wireless devices). Exposure to very loud sound has also been associated in some studies with tinnitus (a ringing in the ear), hypersensitivity to sound and distorted hearing. Individual susceptibility to noise-induced hearing loss and other potential hearing problems varies. The amount of sound produced by a portable audio device varies depending on the nature of the sound, the device, the device settings and the headphones. You should follow some common sense recommendations when using any portable audio device:

- Set the volume in a quiet environment and select the lowest volume at which you can hear adequately.
- When using headphones, turn the volume down if you cannot hear the people speaking near you or if the person sitting next to you can hear what you are listening to.
- Do not turn the volume up to block out noisy surroundings. If you choose to listen to your portable device in a noisy environment, use noise-cancelling headphones to block out background environmental noise.
- Limit the amount of time you listen. As the volume increases, less time is required before your hearing could be affected.
- Avoid using headphones after exposure to extremely loud noises, such as rock concerts, that might cause temporary hearing loss. Temporary hearing loss might cause unsafe volumes to sound normal.
- Do not listen at any volume that causes you discomfort. If you experience ringing in your ears, hear muffled speech or experience any temporary hearing difficulty after listening to your portable audio device, discontinue use and consult your doctor.
- You can obtain additional information on this subject from the following sources:

American Academy of Audiology

11730 Plaza American Drive, Suite 300
Reston, VA 20190
Voice: (800) 222-2336
Email: info@audiology.org
Internet: www.audiology.org

National Institute on Deafness and Other Communication Disorders

National Institutes of Health
31 Center Drive, MSC 2320
Bethesda, MD USA 20892-2320
Voice: (301) 496-7243
Email: nidcdinfo@nih.gov
Internet: <http://www.nidcd.nih.gov/health/hearing>

National Institute for Occupational Safety and Health

Hubert H. Humphrey Bldg.
200 Independence Ave., SW
Washington, DC 20201
Voice: 1-800-35-NIOSH (1-800-356-4674)
Internet: <http://www.cdc.gov/niosh/topics/noise>

Product Handling & Safety

General statement on handling and use: You alone are responsible for how you use your smartphone and any consequences of its use.

You must always switch off your smartphone wherever the use of a phone is prohibited. Use of your smartphone is subject to safety measures designed to protect users and their environment.

- Always treat your smartphone and its accessories with care and keep it in a clean and dust-free place.
- Do not expose your smartphone or its accessories to open flames or lit tobacco products.
- Do not expose your smartphone or its accessories to liquid, moisture, or high humidity.
- Do not drop, throw, or try to bend your smartphone or its accessories.
- Do not use harsh chemicals, cleaning solvents, or aerosols to clean the device or its accessories.
- Do not paint your smartphone or its accessories.
- Do not attempt to disassemble your smartphone or its accessories; only authorised personnel must do so.

- Do not expose your smartphone or its accessories to extreme temperatures, minimum 0 and maximum +45 degrees Celsius. (32F–113F)
- Please check local regulations for disposal of electronic products.
- Do not carry your smartphone in your back pocket as it could break when you sit down.

Battery: Your smartphone includes an internal lithium-ion or lithium-ion polymer battery. Please note that use of certain data applications can result in heavy battery use and may require frequent battery charging. Any disposal of the smartphone or battery must comply with laws and regulations pertaining to lithium-ion or lithium-ion polymer batteries.

Demagnetisation: To avoid the risk of demagnetisation, do not allow electronic devices or magnetic media close to your smartphone for a long time.

Normal use position: When making or receiving a phone call, hold your smartphone to your ear, with the bottom towards your mouth or as you would a fixed line phone.

Emergency calls: This smartphone, like any wireless phone, operates using radio signals, which cannot guarantee connection in all conditions. Therefore, you must never rely solely on any wireless phone for emergency communications.

Smartphone heating: Your smartphone may become warm during charging and during normal use.

Accessories: Use only approved accessories. Do not connect with incompatible products or accessories. Take care not to touch or allow metal objects, such as coins or key rings, to contact or short-circuit the battery terminals.

Connection to a car: Seek professional advice when connecting a phone interface to the vehicle electrical system.

Faulty and damaged products: Do not attempt to disassemble the smartphone or its accessory. Only qualified personnel must service or repair the smartphone or its accessory. If your smartphone or its accessory has been submerged in water, punctured, or subjected to a severe fall, do not use it until you have taken it to be checked at an authorised service centre.

Interference in cars and to other Electronic Devices: Please note that because of possible interference to electronic equipment, some vehicle manufacturers forbid the use of mobile phones in their vehicles unless a hands-free kit with an external antenna is included in the installation. RF energy may affect improperly installed or inadequately shielded electronic operating and entertainment systems in motor vehicles. Check with the manufacturer or representative to determine if these systems are adequately shielded from external RF energy. Also check with the manufacturer of any equipment that has been added to the vehicle.

Driving Safety

Driving Safety Tips Overview

Always obey all laws and regulations on the use of the smartphone in your driving area.

Safety—Your most important call. The Wireless Industry reminds you to use your smartphone safely when driving.

- 1 Get to know your smartphone and its features, such as speed-dial and redial.
- 2 Use a hands-free device.
- 3 Position your smartphone within easy reach.
- 4 Let the person you are speaking to know you are driving; if necessary, suspend the call in heavy traffic or hazardous weather conditions.
- 5 Do not take notes, look up phone numbers, read/write e-mail, or surf the internet while driving.
- 6 Dial sensibly and assess the traffic; if possible, place calls when you are not moving or before pulling into traffic.
- 7 Do not engage in stressful or emotional conversations that may divert your attention from the road.
- 8 Dial your national emergency number to report serious emergencies. This is a free call from your smartphone.
- 9 Use your smartphone to help others in emergencies.
- 10 Call roadside assistance or a special non-emergency wireless number when necessary.

Driving Safety Tips Details

- 1 Get to know your smartphone and its features such as speed-dial and redial. Carefully read your instruction manual and learn to take advantage of valuable features most smartphone models

offer, including automatic redial and memory dial. Also, work to memorize the smartphone keyboard so you can use the speed-dial function without taking your attention off the road.

- 2 Use a hands-free device. A number of hands-free smartphone accessories are readily available today. Whether you choose an installed mounted device for your smartphone or a speakerphone accessory, take advantage of these devices. If driving while using a smartphone is permitted in your area, we recommend using a phone headset or a hands-free car kit (sold separately). However, be aware that use of a headset that covers both ears impairs your ability to hear other sounds. Use of such a headset while operating a motor vehicle or riding a bicycle may create a serious hazard to you and/or others, and may be illegal. If you must use a stereo headset while driving, place a speaker in only one ear. Leave the other ear free to hear outside noises, and do so only if it is legal and you can do so safely.
- 3 Make sure you place your smartphone within easy reach and where you can grab it without removing your eyes from the road. If you get an incoming call at an inconvenient time, let your voicemail answer it for you.
- 4 Suspend conversations during hazardous driving conditions or situations. Let the person you are speaking to know you are driving; if necessary, suspend the call in heavy traffic or hazardous weather conditions. Rain, sleet, snow, and ice can be hazardous, but so is heavy traffic. As a driver, your first responsibility is to pay attention to the road.
- 5 Do not take notes, look up phone numbers, read/write e-mail, or surf the internet while driving. If you are reading an address book or business card while driving a car, or writing a to-do list, then you are not watching where you are going. It's common sense. Don't get caught in a dangerous situation because you are reading or writing and not paying attention to the road or nearby vehicles.
- 6 Dial sensibly and assess the traffic; if possible, place calls when you are not moving or before pulling into traffic. Try to plan your calls before you begin your trip, or attempt to schedule your calls with times you may be temporarily stopped or otherwise stationary. But if you need to dial while driving, follow this simple tip: dial only a few numbers, check the road and your mirrors, then continue.
- 7 Do not engage in stressful or emotional conversations that may be distracting. Stressful or emotional conversations and driving do not mix—they are distracting and even dangerous when you are behind the wheel. Make people you are talking with aware you are driving and if necessary, suspend phone conversations which have the potential to divert your attention from the road.

- 8 Use your smartphone to call for help. Your smartphone is one of the greatest tools you can own to protect yourself and your family in dangerous situations—with your smartphone at your side, help is only three numbers away. Dial your national emergency number in the case of fire, traffic accident, road hazard, or medical emergencies. Remember, your national emergency number is a free call on your smartphone.
- 9 Use your smartphone to help others in emergencies. If you see an auto accident, crime in progress, or other serious emergency where lives are in danger, call your national emergency number, as you would want others to do for you.
- 10 Call roadside assistance or a special wireless non-emergency assistance number when necessary. Certain situations you encounter while driving may require attention, but are not urgent enough to merit a call to your national emergency number. But you can still use your smartphone to lend a hand. If you see a broken-down vehicle posing no serious hazard, a broken traffic signal, a minor traffic accident where no one appears injured, or a vehicle you know to be stolen, call roadside assistance or other special non-emergency wireless number.

End user notice

Microsoft® Voice Command Version 1.5 for Windows Mobile®

NOTE The Voice Command application is not available in all languages. See [Setting up voice commands](#).

IMPORTANT Do not become distracted from driving safely if operating a motor vehicle while using Device Software. Operating certain parts of this Device requires user attention. Diverting attention away from the road while driving can possibly cause an accident or other serious consequences. Even occasional, short diversions of attention can be dangerous if your attention is diverted away from your driving task at a critical time. Do not change system settings or enter data non-verbally (using your hands) while driving. Stop the vehicle in a safe and legal manner before attempting these operations. This is important since while setting up or changing some functions you might be required to distract your attention away from the road and remove your hands from the wheel.

Microsoft makes no representations, warranties, or other determinations that ANY use of the Software Product is legal, safe, or in any manner recommended or intended while driving or otherwise operating a motor vehicle.

General Operation

Voice Command Control: Many of the functions of the Device Software can be accomplished using only voice commands. Using voice commands while driving allows you to initiate the command with a button and then operate the Device mostly without removing your hands from the wheel.

Prolonged Views of Screen: If you are driving, do not access any function requiring a prolonged view of the screen. Pull over in a safe and legal manner before attempting to access a function of the system requiring prolonged attention. Even occasional short scans to the screen may be hazardous if your attention has been diverted away from your driving task at a critical time.

Let Your Judgment Prevail: The Device Software is only an aid. Make your driving decisions based on your observations of local conditions and existing traffic regulations. The Device Software is not a substitute for your personal judgment.

Volume Setting: Do not raise the volume excessively. Keep the volume at a level where you can still hear outside traffic and emergency signals while driving. Driving while unable to hear these sounds could cause an accident.

Use of Speech Recognition Functions: Speech recognition software is inherently a statistical process which is subject to errors. It is your responsibility to monitor the speech recognition functions and address any errors.

Hands-Free Capability

All CTIA Certified portable products provide the consumer with a toll-free number for the purchase of a compatible hands-free device. 1-800-881-7256.

ESD Safety

Electrostatic discharge (ESD) can cause damage to electronic devices if discharged into the device, so you should take steps to avoid such an occurrence. Do not touch the SIM card's metal connectors.

Description of ESD

Static electricity is an electrical charge caused by the buildup of excess electrons on the surface of a material. To most people, static electricity and ESD are nothing more than annoyances. For example,

after walking over a carpet while scuffing your feet, building up electrons on your body, you may get a shock—the discharge event—when you touch a metal doorknob. This little shock discharges the built-up static electricity.

ESD-susceptible equipment

Even a small amount of ESD can harm circuitry, so when working with electronic devices, take measures to help protect your electronic devices, including your Palm™ handheld, from ESD harm. While Palm has built protections against ESD into its products, ESD unfortunately exists and, unless neutralized, could build up to levels that could harm your equipment. Any electronic device that contains an external entry point for plugging in anything from cables to docking stations is susceptible to entry of ESD. Devices that you carry with you, such as your handheld, build up ESD in a unique way because the static electricity that may have built up on your body is automatically passed to the device. Then, when the device is connected to another device such as a docking station, a discharge event can occur.

Precautions against ESD

Make sure to discharge any built-up static electricity from yourself and your electronic devices before touching an electronic device or connecting one device to another. The recommendation from Palm is that you take this precaution before connecting your handheld to your computer, placing the handheld in a cradle, or connecting it to any other device. You can do this in many ways, including the following:

- Ground yourself when you're holding your mobile device by simultaneously touching a metal surface that is at earth ground.
- For example, if your computer has a metal case and is plugged into a standard three-prong grounded outlet, touching the case should discharge the ESD on your body.
- Increase the relative humidity of your environment.
- Install ESD-specific prevention items, such as grounding mats.

Conditions that enhance ESD occurrences

Conditions that can contribute to the buildup of static electricity in the environment include the following:

- Low relative humidity.

- Material type (The type of material gathering the charge. For example, synthetics are more prone to static buildup than natural fibers like cotton.)
- The rapidity with which you touch, connect or disconnect electronic devices.

While you should always take appropriate precautions to discharge static electricity, if you are in an environment where you notice ESD events you may want to take extra precautions to protect your electronic equipment against ESD.

Owner's Record

The model number, regulatory number, and serial number are located on a nameplate inside the battery compartment. Record the serial number in the space provided below. This will be helpful if you need to contact us about your phone in the future.

Product: Palm® Treo™ Pro Smartphone

Model:

Serial No.:

Other International Requirements

France Audio Requirements:

Precaution against hearing loss: Protect your hearing. Listening to this device at full volume for a long period of time can damage your hearing.



A pleine puissance, l'écoute prolongée du baladeur peut endommager l'oreille de l'utilisateur. Consultez notre site web www.palm.com/fr pour plus d'informations.

Complies with
IDA Standards
DA 102238



Specifications

Radio	<ul style="list-style-type: none">• Dual mode GSM/UMTS phone• GSM 850/900/1800/1900 quad band• UMTS 850/1900/2100 tri-band• GPRS• EDGE• UMTS PS data• HSDPA Category 5 (3.6 Mb)
Phone features	<ul style="list-style-type: none">• Personal speakerphone• Hands-free headset jack (3.5 mm, 3-barrel connector)• Microphone mute option• TTY-compatible
Processor technology	<ul style="list-style-type: none">• Dual-core MSM7201 processor—400MHz
Expansion	<ul style="list-style-type: none">• microSD card slot
Battery	<ul style="list-style-type: none">• Rechargeable lithium-ion• 1500mAh power• Removable for replacement• 3.5 hours full charge time
Operating system	<ul style="list-style-type: none">• Windows Mobile® 6.1 Professional
Camera	<ul style="list-style-type: none">• Still image capture resolution:1280 x 1024, 2 megapixel• 8x digital zoom

Size	<ul style="list-style-type: none"> • 114mm x 60mm x 13.5mm (4.5 in. x 2.36 in. x 0.53 in.)
Weight	<ul style="list-style-type: none"> • 130 grams (4.6 ounces)
Connectivity	<ul style="list-style-type: none"> • Infrared (1.0 compliant) • Bluetooth® wireless technology (2.0 + EDR compliant) • Wi-Fi (802.11 b/g)
Display	<ul style="list-style-type: none"> • Touch-sensitive LCD screen (includes stylus) • 65,536 colors (16-bit color) • Resolution: 320 x 320 • User-adjustable brightness
Keyboard	<ul style="list-style-type: none"> • Built-in 30-key keyboard plus 5-way navigator • Backlight for low lighting conditions
Included software	<ul style="list-style-type: none"> • Today/Phone (includes Speed Dial and Keypad) • Messaging (text, multimedia, and email) • Internet Explorer Mobile (web browser) • Camera • Pictures & Videos • Windows Media Player Mobile • File Explorer • Contacts • Calendar • Tasks • Notes

Included software (continued)	<ul style="list-style-type: none">• OneNote• Task Manager• Calculator• ActiveSync®• Microsoft Office Excel Mobile®• Microsoft Office Word Mobile®• Microsoft Office PowerPoint Mobile®• Adobe® Reader® LE• Voice Command (English, French, German only)• Quick Tour• Search• Remote Desktop Mobile• QuickGPS• SIM Manager• Internet Sharing• Java• Windows Live (not available from all wireless service providers)• Windows Live Messenger (not available from all wireless service providers)• Streaming Media• Bluefire VPN client• Sprite Backup
----------------------------------	--------------------------------------------------------------------------------------------------------------------------------------------------------------------------------------------------------------------------------------------------------------------------------------------------------------------------------------------------------------------------------------------------------------------------------------------------------------------------------------------------------------------------------------------------------------------------------------------------------------------------------------------------------------------------------------------------------------------------------------------------------

System requirements (for sync with desktop sync software using USB cable)	<ul style="list-style-type: none">• Windows XP or Vista (later versions may also be supported)• 32MB of available memory (RAM)• 170MB of free hard disk space• Available USB port
Operating and storage temperature range	<ul style="list-style-type: none">• 0° C to 50° C (32° F to 122° F)• 5% to 90% RH

Index

SYMBOLS

! on battery icon 22

NUMERICS

112 calls 52, 297

1st day of week option 227

3G networks 57

3G status icons 66

5-way navigator 29, 31, 338

911 calls 52, 297

999 calls 52, 297

A

accented characters 37

accessing

alternate characters 37

applications 292

menu items 32, 33, 34

on-device help 13

online support 13, 26

Outlook folders 329

remote files 310

the Internet 309, 323

account information 19

accounts

See also email accounts

enabling TTY/TDD devices
and 74

getting help with 13

making phone calls and

55, 59, 60, 76

preventing unauthorized

use of 297, 304

sending messages and

142

troubleshooting 332

Acrobat Reader 235

action keys. *See* softkeys

activating

items on screen 32

SIM cards 21

active calls 55, 58

See also phone calls

ActiveSync

defined 341

opening 93, 94

synchronizing with 93,

315, 326

troubleshooting 315, 326–

331

ActiveSync desktop software

85, 341

ActiveSync icon 95, 194, 341

Add new device option 70,

185

Add new phone number to

Contacts option 75

Add Server Source command
96

Add to Personal Address

Book command 329

Add to Speed Dial command

63

adding

a second call 58

applications 292

appointments 223, 224

attachments to email 117,

135, 269

connections 310

contacts 53, 120, 151,

217

document templates 242

expansion cards 276

files to playlists 213

folders 245

notes 218, 229, 231, 233,

259, 260

spreadsheets 247

tasks 228–230

untimed events 224

web favorites 166–167

address books 121–123,

128, 220, 329

Address List Lookup 267

addresses

- copying 329
- creating multimedia
 - messages and 142
- creating text messages
 - and 139, 140
- entering email 116, 128, 218
- entering web 164
- getting 122, 128, 220
- highlighting 31
- looking up corporate 267
- searching for web 43
- selecting 335
- synchronizing 329
- verifying 116, 121
- ad-hoc connections 177
- adjusting screen brightness 290
- Adobe Flash Player 90
- Adobe Reader 235, 240
- Adobe Reader icon 261
- Adobe Reader LE application 261–264
- Advanced tab (Power Settings) 306
- advancing slides 149, 246, 247
- AES encryption 178
- Agenda View (calendar) 222
- airplane mode 48
- alarm clock 303
- alarm sounds 304
- alarms
 - adding 223, 228, 229
 - setting 290, 303
 - turning on and off 289
- Alarms tab 303
- albums 203
- alerts 66
 - See also* alarms
- aligning the screen 292
- alignment settings
 - documents 244
 - spreadsheets 247
- Allow USB connections
 - check box 327
- Alt key 37, 38
- alternate characters 37
- alternate characters list 37
- animation 208, 246, 247
- anniversaries 224
- answering phone calls 53–54, 58, 75
- Appearance tab 287, 292
- application icons 39, 293
- applications
 - See also* third-party applications
- associating with buttons 293
- caution for hard resets and 317
- choosing menu items in 32–34
- closing 40–41
- copying 279
- customizing 292–297
- deleting 272, 338
- downloading 269, 271
- error reporting for 305
- highlighting 39
- included with device 360
- installing 269–272, 337, 338
- losing information in 317
- marking as exclusive 41
- moving to expansion cards 279
- opening 39, 278, 292
- reinstalling 315, 317
- running from expansion cards 278, 338
- running multiple 40
- scrolling in 30
- selecting 39, 40
- storing 338
- switching between 43, 56

- synchronizing info in 86, 87, 88, 102
 - troubleshooting 317, 319
 - turning sounds on or off for 289
 - viewing memory usage for 305
- appointment settings 227–228
- appointments
- adding 223
 - appearing in wrong time slots 330
 - creating reminders for 223, 228
 - deleting 227
 - displaying 43
 - marking as private 225
 - scheduling repeating 224
 - sending 144, 228
 - viewing 222, 223
- area codes 220
- arrow icons 29
- arrow keys 29, 30
- Assign a program list 294
- attachments
- adding 117, 135, 269
 - downloading 119–120
 - embedded objects in 120
 - internal memory and 338
 - opening 119
 - removing from messages 144
 - setting maximum size 130
 - storing 119, 128
 - troubleshooting 334
- attendees (meeting requests) 225
- audio 53, 144, 208
- audio modes 74
- authentication 178, 179
- auto-completion options 295
- AutoFilter settings (spreadsheets) 248, 255
- Auto-Keyguard feature 298
- Auto-Keyguard list 298
- Automatic Send/Receive option 131
- auto-off interval 341
- available memory 306
- available storage space 305
- B**
- background colors 144
- backgrounds 195, 205, 214, 287
- backing up information 315, 317
- backlight (keyboard) 35, 307
- Backlight Settings screen 35
- backlight shut-off interval 35
- Backspace key 32, 37
- backup and restore app 95
- backup utilities 315, 317, 318, 331
- backups, restoring 318, 331
- banners (calendar) 224
- battery
- charging 21–22, 92, 320
 - connecting to Bluetooth devices and 184
 - conserving 23–24, 110, 307
 - disposing of 318
 - inserting 20
 - removing 20, 317, 318
 - replacing 318–319
 - viewing remaining power for 306
 - viewing status of 22, 66
- battery icons 22, 66
- battery specifications 359
- Battery tab 306
- battery technology 342
- beaming 23, 204, 269, 274–276, 341
- birthdays 224
- Blacklist tab 154

- blank screens 320
- Block incoming calls list 77
- Block outgoing calls list 77
- Block Recognizer option 296
- Bluetooth devices
 - See also* hands-free devices
 - beaming and 274, 275
 - connecting to 183–187
 - conserving battery and 23
 - enabling phone as modem and 188
 - synchronizing over 100–101
 - troubleshooting 324
- Bluetooth feature
 - turning on or off 23, 69
 - viewing status of 42
- Bluetooth icon 100
- Bluetooth Settings screen 184–187
- Bluetooth status icons 66
- Bluetooth technology 161, 341
- bonus software 360
- bookmarks 166
 - See also* favorites
- border highlight 31
- brightness, adjusting 290
- broadcast channel options 81–82
- browsing files and folders 268, 280
- browsing the web. *See* web browsing
- built-in applications 272
- built-in camera. *See* camera button settings (Media Player) 214
- buttons
 - assigning voice commands to 294
 - associating with applications 293
 - disabling 298
 - reassigning 293–294
 - selecting 29, 31
 - turning sounds on or off for 289
- Buttons list 293
- Buttons screen 293
- C**
 - calculations 250, 282
 - Calculator application 282–283
 - calculator buttons 283
 - calendar
 - See also* Calendar application
 - adding items to 223, 224, 228
 - displaying 222
 - hiding items on 225
 - moving through 222
 - removing items 227, 230
 - setting alarms for 223, 228, 229
 - sorting tasks on 230
 - unavailable slots on 226
 - viewing appointments on 43
 - Calendar application
 - adding contacts and 218
 - customizing 227–228
 - managing schedules with 223–227
 - opening 222
 - sending meeting requests and 134
 - Calendar icon 222
 - calendar settings 227–228
 - calendar views 222, 227
 - call forwarding 60
 - call forwarding icon 60
 - Call Status softkey 55
 - call waiting 58, 78

- call-barring password [76, 77](#)
- caller ID applications [337](#)
- caller ID blocking [57](#)
- caller ID pictures [195, 204, 218](#)
- caller IDs [74, 77](#)
- call-forwarding icon [65](#)
- camera
 - capturing videos with [199–200](#)
 - overview [195](#)
 - taking pictures [197–199](#)
 - troubleshooting [336](#)
- camera modes [196](#)
- Camera Preview Mode [336](#)
- camera settings [197, 200–202](#)
- camera specifications [359](#)
- cancelling selections in lists [35](#)
- capitalization [36, 297](#)
- Capitalize first letter of sentence check box [297](#)
- Caps Lock icon [36](#)
- Caps Lock mode [36](#)
- captions [143, 144](#)
- capture format [201](#)
- car kits [68, 69, 71](#)
- carrier. *See* service providers
- cascading menus [33](#)
- case-sensitive searching [242, 256](#)
- cell patterns (spreadsheets) [247](#)
- cell references (spreadsheets) [251](#)
- certificates [131, 163, 304](#)
- Certificates icon [304](#)
- Certificates screen [304](#)
- Change PIN 2 option [80](#)
- changing
 - alarm sounds [304](#)
 - calendar views [222](#)
 - color themes [287, 292](#)
 - connections [310](#)
 - contacts [218–219](#)
 - date and time settings [302](#)
 - information [256](#)
 - phone numbers [78](#)
 - picture or video resolution [336](#)
 - PIN numbers [300](#)
 - sync settings [98](#)
 - text [242](#)
 - text size [290](#)
- character sets [169](#)
- characters
 - See also* text
 - capitalizing [36, 297](#)
 - creating messages and [140](#)
 - entering [36, 251](#)
 - highlighting [32](#)
 - moving to specific [30](#)
 - typing alternate [37](#)
- charge indicator [22](#)
- charging smartphone battery [21–22, 92, 320](#)
- charging status [22, 66](#)
- charts [248, 255, 256](#)
- chat sessions [149–150](#)
- chat view [147, 148, 150](#)
- check boxes [31](#)
- Check Names command [116](#)
- Clear Cookies button [169](#)
- Clear Now Playing command [213](#)
- Clear Type tab [290](#)
- Clock & Alarms icon [291, 302, 303](#)
- Clock & Alarms Settings screen [302, 303](#)
- closing
 - applications [40–41](#)
 - drop-down lists [35](#)
 - menus [33](#)
 - screens [30, 31](#)

- color settings 144, 336
- color themes 287, 292
- Comm Manager 48, 185
- command button 295
- commands 295
- Company Directory
 - command 122, 220
- company names 219
- comparisons 255
- completed tasks 229, 230
- compressed files 270
- computers
 - accessing remote 281
 - charging smartphone and 22
 - connecting to 90–91
 - installing from 271, 272
 - reinstalling desktop software on 315
 - synchronizing with 12, 89, 92, 101, 102, 194
 - viewing synchronized items on 92
- conference calls 59–60
- confidential events 226
- configurations, troubleshooting 323
- Configure Server command 334
- Configure Wireless Networks screen 176
- configuring
 - data services 323
 - mail servers 334
 - TTY/TDD devices 74–75
- confirmation messages 147, 153, 154
- Connect command 310
- Connect via Bluetooth command 100
- Connect via IR command 101
- connecting
 - to mobile networks 322
 - to service providers 309
 - to the Internet 309, 323
 - to VPNs 310–??
- connecting smartphone to PCs 90–91
- Connection Settings command 327
- connection status icons 65–67
- connections
 - accessing VPN clients and 310
 - adding Bluetooth devices and 183
 - browsing websites and 161, 163, 174
 - changing 310
 - conserving battery and 18, 23
 - creating 310
 - displaying 310
 - enabling Bluetooth 69, 100
 - enabling TTY/TDD 74–75
 - enabling Wi-Fi 175
 - ending 311
 - inserting SIM cards and 19
 - losing 324
 - making phone calls and 57
 - manually starting 310
 - setting up 309–311
 - streaming and 171
 - synchronizing and 86, 92
 - timing out 332
 - troubleshooting 321–325, 335
- Connections icon 309, 310
- Connections screen 309, 310, 323, 324
- Connections tab 309, 310
- connectivity specs 360
- conserving smartphone battery 23–24, 110, 307

- contact categories 218
- Contact Details command
 - 141, 149
- contact lookup feature 50, 218
- contact names, dialing by 50–51
- contact types 217
- contacts
 - adding 53, 120, 151, 217
 - assigning caller IDs 77, 204, 218
 - assigning ringtones 74, 218
 - assigning speed dial numbers 63–64
 - copying 218
 - editing 218–219
 - getting from address
 - books 122, 220
 - removing 219
 - saving info for 57–58
 - searching for 50, 218, 219, 220
 - selecting 219
 - sending 144, 220–221
 - transferring to car kits 72
 - viewing information about 141, 149, 220
- Contacts application 217–222
- Contacts list 220
- context-sensitive menus 33, 34
- continuous playback (slides) 247
- cookies 163, 169
- copying
 - addresses 329
 - applications 279
 - contacts 218
 - documents 243
 - items in folders 269
 - media files 194
 - phone numbers 51, 53, 168
 - pictures or videos 205
 - text 168, 242
- copyrighted items 204
- corporate email passwords 97
- corporate mail systems 107, 310, 334
- corporate networks 304
- corporate servers 310, 334
- coupling 338
- coverage areas 12, 23, 47, 321
- creating
 - appointments 224
 - connections 310
 - contacts 53, 120, 151, 217
 - documents 240, 241
 - email messages 116–117
 - folders 245
 - meeting invitations 134
 - meeting requests 225
 - message templates 145
 - multimedia messages 142–145
 - notes 218, 229, 231, 233, 259, 260
 - passkeys 70, 186
 - playlists 212–213
 - reminders 223, 228, 229, 231
 - spreadsheets 247
 - tasks 228–230
 - templates 242, 249
 - text messages 139–141
 - untimed events 224
 - web favorites 166–167
 - workbooks 249
- credentials 311, 332
- cropping pictures 206
- currency symbols 292

Custom domain option 112
customer assistance 13
customizing
 applications 292–297
 Calendar 227–228
 Contacts application 220
 dates and time 302
 Excel Mobile 258
 format settings 291
 Internet Explorer Mobile
 168–170
 Media Player Mobile 213
 Notes application 234
 Quick Menu 41
 system settings 302–308
 system sounds 288
 tasks 230–231
 Today screen 287
 Word Mobile 245
cutting. *See* deleting

D
daily schedules 222
data 317
 See also information
data formats 291
data service icons 322
data service providers 12, 42,
 57, 309, 333
data services 12, 322

data transmissions 12, 19
date format settings 292
dates 252, 292, 302
 See also calendar
Day View 222, 227
decimal places 291
decimal symbols 291, 292
decompression utility 270
default PINs 299
defined names
 (spreadsheets) 254
delays 324
Delete All Calls command 62
Delete Call command 62
Deleted folder 129, 338
Deleted Items folder 152
deleting
 See also removing
 applications 272, 338
 certificates 305
 contacts 219
 documents 245
 email 124, 128, 129, 132
 email accounts 115
 events 227
 favorites 166
 files 269, 338
 items in folders 269
 messages 152

notes 234, 261
partnerships 186, 325
pictures or videos 206
tasks 230
text 32, 50
text or multimedia
 messages 147, 154
web files 169
workbooks 258
worksheets 258
desktop software 341
 See also applications;
 software
device names 345
devices
 See also Bluetooth
 devices; smartphone
 beaming to 274
 configuring TTY/TDD 74–
 75
 connecting headset 68–69
 discovering trusted 184,
 186
 transferring info from 90,
 315
 troubleshooting 324
Devices tab 324
device-to-device connections
 177

- diagnostic information 305
- dial pad. *See* keypad
- dialing 49–53
- dialog boxes 341
- digit grouping symbols 291, 292
- digital cameras 202
 - See also* camera
- digital certificates 131, 163, 304
- digital notebook 258
- digital signatures 130
- dimmed images 320
- Direct Push Technology 96
- directory services 121–123, 128, 220
- Disable touchscreen check box 299
- Disconnect Bluetooth
 - command 101
- disconnecting from Wi-Fi networks 179
- discovering trusted devices 184, 186
- disk space 362
 - See also* memory
- display formats 291
- Display message on screen option 290
- display names (email) 109, 112
- display options (web) 164
- display settings (screen) 290
- displaying
 - alternate characters 37
 - animated images 208
 - application menus 32, 33, 34
 - appointments 43, 222, 223
 - calendar 222
 - contact info 141, 149, 220
 - current connection 310
 - events 224, 226
 - folder contents 268
 - memory usage 305
 - notifications 290
 - on-device help 13
 - PDF documents 261
 - pictures 202, 203, 260
 - power settings 306
 - service provider 42
 - space on expansion cards 280, 306
 - speed dial numbers 64
 - tasks 230, 231
 - unread messages 43, 49
 - videos 203
 - voicemail messages 54
 - web favorites 166
 - web pages 163, 164, 165
 - wireless settings 307
- disposal information 2
- document file types 239, 245
- documentation 11, 13, 47
- documents
 - See also* Word Mobile application
 - creating 240, 241
 - deleting 245
 - finding and replacing text in 242
 - moving or copying text in 242
 - opening 241
 - renaming 245
 - saving 240, 241, 243, 245
 - setting margins for 244
 - spell-checking 244
- documents list 245
- domains 312
- Download messages option 132
- Download size limit list 98
- Download size limit option 130

- Download Size Settings
 - screen 133
- downloading
 - Adobe Flash Player 90
 - applications 269, 271
 - attachments 119–120
 - email 23, 117–119, 129, 131
 - email messages 98
 - files 167
 - images 208
 - Media Player 87
 - multimedia messages 147, 154
 - Outlook 87
 - Palm information and updates 13
 - pictures 167
 - ringtones 72
 - videos 208
- downward-pointing arrows 34
- drafts 117, 141
- drawing 232
- driving directions 267
- drop-down lists
 - cancelling selection in 35
 - closing 35
 - highlighting items in 29, 31, 34
 - scrolling through 30
 - selecting items in 34
- drop-down menus 33
- E**
- EAP authentication type 179
- earpiece 339
- echoes 338
- EDGE connections 342
- EDGE status icons 67
- Edit sender's message option 123
- editing. *See* changing
- email
 - See also* email messages
 - adding attachments to 269
 - adding contacts and 120, 218
 - conserving battery and 110
 - downloading 23, 117–119, 129, 131
 - downloading attachments with 119–120
 - getting from corporate servers 310, 334
 - internal memory and 338
 - overview 105
 - saving passwords for 109
 - sending 117, 124, 132, 135, 165, 333
 - setting security options for 130
 - synchronizing 86, 95, 118
 - troubleshooting 332–334
- email accounts
 - changing display names for 109, 112
 - changing settings for 115
 - deleting 115
 - selecting 115, 127
 - setting up 107–115
 - troubleshooting 332
- email addresses
 - entering 116, 128, 218
 - highlighting 31
 - verifying 116, 121
- email applications 335
- email client software 334
- email message search feature 267
- email messages
 - adding attachments 117, 135
 - adding signatures to 125
 - creating 116–117

- deleting 124, 128, 129, 132
- dialing from 52
- displaying 43
- downloading 98, 118
- finding 123
- forwarding 124
- opening attachments in 119
- receiving 117–119, 129, 131
- replying to 123, 127
- saving 117
- setting maximum size 133
- setting priority 117
- sorting 124
- storing copies of 127
- email providers 108, 110
- email settings 126–133
- email shortcuts 125
- emergency calls 52, 297
- emoticons 143, 159
- Empty Deleted Items
 - command 152
- Enable Clear Type option 290
- Enable fixed dialing option 79
- Enable local network time option 303
- Enable Quick Menu option 41
- Enable TTY support option 75
- encryption 130, 163, 178, 281
- ending data connections 311
- entry fields
 - deleting text in 32
 - highlighting text in 32
 - moving to 29
 - scrolling through 30
- Erase all data? prompt 318
- erasing. *See* deleting
- error messages 289, 331
- Error Reporting icon 305
- Error Reporting screen 305
- errors 195, 305, 322, 331
- event categories 226
- event icons 228
 - adding reminders for 223, 228
 - creating 224, 225
 - deleting 227
 - displaying messages for 73
 - filtering 226, 227
 - marking as sensitive 225
 - selecting sounds for 73, 290
- Excel files 235
 - See also* Excel Mobile; spreadsheets
- Excel Mobile application
 - customizing 258
 - overview 247
 - searching in 256
 - starting 249
- Excel Mobile icon 249
- Exchange ActiveSync 86, 95, 334, 342
- Exchange Address Book 329
- Exchange server credentials screen 332
- Exchange server sync options 332
- Exchange servers
 - changing sync settings for 98
 - finding contacts and 220
 - getting email from 117
 - sending email over 108, 112, 122
 - sending meeting requests and 225
 - setting sync schedules for 98, 99

- setting up accounts for
 - 96–98
- synchronizing with 86, 95, 331, 332
- troubleshooting 332, 334
- Exclusive Programs list 41
- EXIF formats 342
- expansion card slot 359
- expansion cards
 - as storage medium 338
 - browsing on 280
 - displaying available space on 280, 306
 - encrypting 281
 - inserting 277
 - installing apps on 272
 - moving apps to 279
 - moving information to 257, 279
 - opening items on 278
 - organizing pictures and videos on 205
 - removing 277
 - renaming 280
 - searching on 267, 269
 - storing attachments on 119, 128
 - transferring files to 208, 212, 278, 279
 - types supported 276
 - external power sources 306
- F**
- factory defaults 214
- factory-installed applications 272
- favorites 87, 143, 166–167
 - See also* web pages
- Favorites application 87
- features (smartphone) 11, 13
- Federal Trade Commission website 305
- feedback 339
- fields. *See* entry fields
- File Explorer 267, 268–269, 280
- File Explorer icon 268
- file names 167, 243, 267
- file types
 - documents 239, 245
 - media files 208
 - multimedia 142
 - pictures 202
 - ringtones 72
 - videos 203
- files
 - accessing from corporate accounts 310
- attaching to messages
 - 130, 135, 140, 141, 142, 144
- browsing 268
- copying 194
- decompressing 270
- deleting 269, 338
- downloading 167
- moving 245, 269
- renaming 167
- saving 167, 278
- searching for 267, 269
- selecting multiple 269
- transferring to expansion cards 208, 212, 278, 279
- viewing information about 149, 213
- fill series (spreadsheets) 252
- filtering
 - events 226, 227
 - information 219, 255
 - recent calls list 61
 - tasks 230
- finding
 - contacts 50, 218, 219, 220
 - email messages 123
 - information 256

- text 242, 263
- firewalls 325
- first-letter capitalization
 - option 297
- 5-way navigator 29, 31, 338
- fixed-dialing feature 79
- Flash Player 90
- flicker adjustment 202
- flight mode 48
- folder names 245
- folders
 - accessing Outlook 329
 - adding documents to 243
 - browsing 268, 280
 - creating 167, 245
 - moving items to 245, 257, 269
 - opening items in 269
 - organizing pictures and videos in 205
 - organizing web favorites in 166, 167
 - sorting contents 269
 - synchronizing info and 92
- fonts 240, 243, 247, 290
- forgetting passwords 300
- format settings 291
- formats
 - losing 240
 - saving documents and 243
 - sending email and 130, 133
- formatting
 - charts 256
 - paragraphs and lists 244
 - spreadsheets 247, 253–254
 - system data 291
 - text 243, 259
 - text messages 144
- Formatting toolbar 244
- forms (web pages) 165
- formulas 248, 251, 258
- forwarding
 - messages 124, 149
 - phone calls 60
- freeing memory 272, 331, 338
- Freeze Panes option 250
- full-charge indicators 22
- functions (spreadsheets) 248, 251
- G**
 - games 272
 - gestures 296
 - Getting Started* guide 11
- Global Address List Lookup
 - feature 267
- Global Address Lists 96, 121–123, 128, 220
- GPRS connections 342
- GPRS networks 57
- GPRS status icons 67
- GPS icon 66
- graphics programs 205
- H**
 - Hands Free check box 325
 - hands-free car kits 68, 69, 71
 - hands-free devices
 - connecting to 69–71
 - entering passkeys for 70
 - making phone calls and 71
 - troubleshooting 324, 325
 - turning Keyguard on or off for 298
 - turning on or off 71
 - hard resets 300, 317
 - hardware 11
 - headset button 68
 - headsets 68–69, 71, 184, 298
 - heat sources 24
 - help 13, 313
 - hiding
 - calendar items 225

- images 164
- highlight 31
- highlighting
 - applications 39
 - email addresses 31
 - items in folders 269
 - menu items 33, 34
 - options in lists 29, 34
 - phone numbers 52
 - text 32, 243
 - web links 31, 165
- high-speed data connections 19
- Hint tab 301
- hints (passwords) 301
- History list 168, 169
- Hold option 56
- home locations 302
- home page (browser) 165, 168
- Hotmail 108, 115, 155
- hotspots 174
- HSDPA networks 57
- HSDPA packet data 342
- HSDPA status icons 67
- HTML formats 119, 124
- hypertext links. *See* links
- I
- icons
 - See also* specific type
 - Identification tab 301
 - Ignore softkey 53
 - image files 142, 202, 338
 - image properties 202
 - images
 - See also* pictures
 - dimmed 320
 - downloading 208
 - embedding in
 - attachments 120
 - hiding web page 164
 - incorrect color settings and 336
 - setting background 205, 287
 - troubleshooting web page 335
 - IMAP email accounts 107, 108–115
 - inactivity 306
 - Inbox 43, 110, 147
 - Inbox folders 118, 124
 - See also* specific folder
 - incoming mail server settings 113
 - incorrect passwords 300
 - indentation 244
 - indicator light 22, 47
- information
 - backing up 315, 317
 - changing 256
 - displaying 42
 - entering 36–37, 85, 218
 - erasing all 325
 - filtering 219, 255
 - losing 240, 317
 - managing 265
 - moving 279
 - protecting 297–301
 - removing battery and 318
 - restoring 317, 318
 - searching for 267–268
 - sharing 273–274
 - sorting 255
 - storing 276, 338
 - transferring from previous devices 90, 315
 - updating 85
- infrared port. *See* IR port
- infrared transmissions 101, 342
- Input icon 295
- input method 296
- input options 36, 295
- Input screen 295, 297
- Insert Pause command 121
- Insert Wait command 121

- inserting
 - expansion cards 277
 - SIM cards 19–21
 - smartphone battery 20
- installation, troubleshooting 317, 337
- installing
 - applications 269–272, 337, 338
 - sync software 85, 86, 90
 - VPN clients 310
- instant messages 155
- instant messaging
 - applications 337
- internal memory. *See* memory
- international adapters 21
- international call blocking 77
- Internet 309, 323
 - See also* web browsing
- Internet Connection Sharing 187–189
- Internet Connection Speed option 214
- Internet email accounts 107, 112
- Internet Explorer Mobile
 - browsing with 163–168
 - closing 164
 - customizing 168–170
 - installing from 270
 - scrolling in 30
 - starting 163
 - unsupported elements for 335
- Internet Sharing icon 187
- IP-based push updating 96
- IR connections 275
- IR port 101, 274, 342
- ISP settings 309
- ISPs (Internet Service Providers) 107, 309, 333
- Items tab 287
- J**
- Java applets 163
- Java applications 272
- K**
- keyboard
 - accessing alternate characters on 37
 - dialing from 49, 51
 - entering information from 36–37, 297
 - locking 298
 - looking up contacts from 50
 - resizing keys on 296
 - scrolling with 29, 30
 - selecting menu items with 33
 - setting key combinations for 293
 - troubleshooting 338
- keyboard backlight 35, 307
- keyboard icon 36
- keyboard specifications 360
- Keyguard 298, 299
- Keyguard icon 298
- keypad 51
- Keypad softkey 51
- keys (keyboard) 35, 296
- Known Caller option 72
- L**
- language settings 117, 153
- lanyards 18
- leading zeros 292
- LED light 22, 47
- Legacy Pocket Word files 240
- Letter Recognizer 296
- libraries (media) 210, 211
- Library screen 214
- lightning bolt 22
- Li-Ion battery. *See* battery links
 - creating 260
 - highlighting 31

- internal memory and 338
- playing media files and 211
- selecting 127, 165, 260
- sending 165
- troubleshooting 335
- list separators 291
- lists
 - cancelling selection in 35
 - closing 35
 - creating 241, 244, 259
 - formatting 244
 - highlighting items in 29, 31, 34
 - scrolling through 30, 165
 - selecting items in 34
- Lithium Ion battery. *See* battery
- Live Search 155
- locating
 - contacts 50, 218, 219, 220
 - email messages 123
 - information 256
- location-specific information 291, 302
- Lock icon 164, 204, 300
- locking
 - SIM smartcards 299
 - smartphone screen 56, 299
 - smartphone system 300
 - spreadsheet rows and columns 250
 - the keyboard 298
- logging in to
 - corporate servers 310
 - networks 304
- looking up contacts 50, 218, 219, 220
- lookup feature 267
- losing
 - connections 324
 - information 240, 317
 - passwords 300
 - smartphone 95, 301
- low coverage areas 321
- low light conditions 35
- lowercase letters 36
- M**
- magnification. *See* zoom
- mail. *See* email
- mail servers 113, 334
- Main tab 305
- Manage existing connections
 - option 309, 310
 - Manage Folders command 118, 133
- Manage tab 289
- management tools 265
- MAPI clients 334
- maps 335
- margins 244
- Match case option 242, 256
- Match entire cells option 256
- Match whole words only
 - option 242
- maximizing battery 23–24, 110, 307
- measurement units 292
- media file types 208
- media files
 - adding to playlists 212–213
 - copying 194
 - playing 210
 - storing 211
 - synchronizing 87, 193–195, 208–210
 - transferring 208, 212
 - troubleshooting 330
- Media Player 87, 330
- Media Player library 210, 211
- Media Player Mobile 87, 208–214

- meeting invitations. *See* meeting requests
- meeting requests 122, 134, 224–225, 228
- memory
 - displaying available 280
 - freeing 272, 331, 338
 - low conditions for 305
 - running apps and 278
 - storing numbers in 283
- memory buttons 283
- Memory icon 280, 305
- memory options (web) 169
- memory requirements 362
- Memory screen 305
- memory usage 305
- memos. *See* messages; notes
- menu items 32–34
- Menu key 32, 33
- menus 32, 33, 34
- Menus icon 293
- Menus screen 293
- Message Detail command 141, 149
- Message format option 130
- Message Options screen 117
- message preferences 152–155
- message templates 145
- messages
 - See also* email, multimedia, and text messages
 - dialing from 52
 - displaying notification 290
 - displaying unread 43, 49
 - formatting 144
 - receiving system 81
 - storing 338
 - viewing info about 141, 149
 - viewing voicemail 54
- Messaging application
 - See also* text messages; multimedia messages
 - adding contacts and 218
 - receiving meeting requests and 134
 - receiving messages and 148
 - sending email from 107, 116, 121, 126
 - sending messages from 139, 142, 152
 - starting chat sessions and 150
- messaging applications 337
- Messaging icon 139
- Messaging Options screen 115
- messaging services 324, 342
- Metering mode 201
- microphone 56, 65, 339
- microphone icon 295
- microSD cards 276
- Microsoft ActiveSync
 - software. *See* ActiveSync desktop software; Exchange ActiveSync
- Microsoft Exchange servers. *See* Exchange servers
- Microsoft Media Player. *See* Media Player; Media Player Mobile
- Microsoft Office Excel 248
 - See also* spreadsheets
- Microsoft Office files 235, 237
- Microsoft Office Outlook. *See* Outlook

- Microsoft Windows Mobile software 270
 - Microsoft Windows Mobile website 315
 - Microsoft Word documents. *See* documents
 - microUSB connector 92, 320
 - Missed call option 72
 - MMS messaging 139, 342
 - MMS video icon 199
 - mobile accounts. *See* accounts
 - Mobile Device component 342
 - mobile devices 90, 274, 315
 - Mobile Favorites folder 87
 - mobile features 13
 - mobile networks 321, 322
 - mobile phone numbers 218
 - Mobile to Market certificates 270
 - Modem tab 310
 - modems 183, 187
 - Month View 222
 - most recently dialed numbers list 52
 - moving
 - documents to folders 245, 269
 - files to expansion cards 208, 212, 278, 279
 - information 279
 - pictures or videos 205
 - text 242
 - workbooks 257
 - moving around the screen 29–30
 - multi-line fields 30
 - multimedia file types 203
 - multimedia files 202, 338
 - multimedia messages
 - checking for 65
 - creating 142–145
 - deleting 147, 152, 154
 - dialing from 52, 147
 - displaying 43, 49
 - forwarding 149
 - internal memory and 338
 - opening 148
 - receiving 147, 154
 - removing items from 144
 - replying to 147, 148, 149
 - saving 154
 - selecting links in 150
 - sending 142, 145, 146–147, 154
 - setting preferences for 152–155
 - sorting 151
 - troubleshooting 324
 - viewing status of 65
 - Multimedia Messaging System. *See* MMS messaging
 - music 53, 191, 208, 288
 - See also* media files; playlists
 - music files 193, 330
 - muting phone calls 56
 - My Device folder 268
 - My Device library 211
 - My Documents folder 195, 267, 317
 - My Music folder 193
 - My Pictures folder 193, 197, 199
 - My Playlists category 212
 - My Storage Card library 211
 - My Text phrases 116, 140
 - My Treo application 26
 - My Videos folder 193
- N**
- names
 - dialing by contact 50–51
 - displaying service provider 42

- finding contact 50, 218, 219, 220
- naming
 - document files 243, 245
 - expansion cards 280
 - folders 245
 - templates 242, 249
 - workbooks 257
 - worksheets 253, 254
- national emergency numbers 52
- navigation features 29
- navigator buttons 29, 31
- negative numbers 292
- network keys 178
- network protocols 214
- network settings 81
- networks
 - changing 81
 - connecting to 81, 175, 176
 - disconnecting from 179
 - logging in to 304
 - troubleshooting 321–325
- New Sound command 289
- note options 234
- notebook 258
- notes
 - adding 218, 229, 259, 260
 - creating 231, 233
 - deleting 234, 261
 - renaming 233, 261
 - saving 233, 234
- Notes application 231–234
- Notes icon 231
- Notes list 233
- Notes tab 302
- notification options 289
- notification screens. *See* notifications
- notifications
 - creating events and 73
 - enabling or disabling 290
 - receiving information and 187
 - receiving messages and 147, 148, 153, 154
 - receiving phone calls and 58, 78
 - receiving voicemail 55
 - sending messages and 140, 147
 - setting ringtones for 72
 - setting system sounds for 289
 - silencing sounds for 288
 - troubleshooting 324
- Now Playing playlist 212
- number format settings 291
- number sign symbol 292
- numbers
 - See also* phone numbers
 - entering 36
 - formatting 247, 252
 - pasting into Calculator 283
- O**
 - Office files 235, 237
 - Office Outlook. *See* Outlook
 - Office Word documents. *See* documents
 - offline synchronization 329
 - on-device components 17, 18
 - on-device help 13
 - OneNote files 235
 - OneNote Mobile 258–261
 - online address books 121–123, 128, 220
 - online support 13, 26
 - online travel information 172
 - onscreen keypad 51
 - opening
 - ActiveSync 93, 94
 - Adobe Reader 240
 - alternate characters list 37
 - application menus 32, 33, 34

- applications 39, 278, 292
- chat view 150
- documents 241
- email applications 335
- email attachments 119
- File Explorer 268
- Inbox 43
- items in folders 269
- multimedia messages 148
- notebook 260
- Outlook folders 329
- Quick Menu 43
- Quick Tour 13, 42
- sync software window 93
- text messages 148
- Today screen 42
- web pages 163, 166, 168, 335
- operating system (device) 320, 345, 359
- operating systems (PCs) 89
- Option key 29, 30, 36, 39, 50
- Option Lock icon 36
- Option Lock mode 36
- options
 - displaying 226
 - highlighting 29, 31, 34
 - selecting 34–35
- Options tab 288, 297, 302
- Organize Slides command 145
- organizer features 48, 215
- orientation (slides) 246
- outages 323
- outgoing mail server settings 113
- Outlook
 - accessing folders for 329
 - copying addresses to 329
 - downloading 87
 - downloading mail and 107, 118, 119, 129
 - synchronizing with 86, 95, 96, 123
- Outlook email accounts 115
- overdue tasks 230
- Owner Information icon 301
- Owner Information screen 301
- P**
 - paired relationships. *See* partnerships
 - pairing. *See* partnerships
 - Palm online support 13
 - Palm OS applications 270
 - Palm OS devices 90, 315
 - paragraph formatting 244
 - paragraph highlight feature 32
 - partial envelope icon 119
 - partially-charged battery icon 22
 - partnerships 183, 186, 325, 343
 - passkeys 70, 186
 - Password tab 300
 - Password type list 301
 - password types 52
 - passwords
 - entering 37, 97, 300, 301
 - forgetting or losing 300
 - locking device and 298, 301
 - saving 109, 111
 - setting up email accounts and 109, 111
 - specifying call-blocking and 76, 77
 - spreadsheets and 248
 - storing on smartphone 97
 - patches 272
 - Pause playback option 213
 - PCs. *See* computers
 - PDF files 119, 235, 261
 - performance 319, 337
 - Personal Address Book 329

- personal computers. *See* computers
- personal events 226
- personal identification
 - numbers (PINs) 79, 80, 300, 343
- personal information 19, 300, 301, 341
- personal information managers 329, 343
 - See also* PIM applications
- personal unblocking key 344
- personalizing smartphone 285
- phone
 - See also* phone calls;
phone numbers;
smartphone
 - answering 53–54, 58, 75
 - dialing 49–53
 - disabling touch-sensitive feature for 298
 - driving and 68
 - getting started with 24–25
 - locking screen and 56
 - playing music and 53
 - redialing 52
 - running applications and 57
 - selecting ringtones for 72
 - selecting wireless band for 80
 - sending text messages and 56
 - setting network preferences for 81
 - silencing ringer for 53
 - turning on or off 23, 47, 48, 53
- phone as modem feature 183, 187–189
- phone calls
 - See also* phone numbers
 - adding a second 58
 - adding notes about 56, 61, 63
 - adjusting volume for 74
 - automatically answering 75
 - blocking 76–77
 - customizing sounds for 73
 - ending 56
 - extracting private 59, 60
 - forwarding 60
 - holding 56
 - making 24, 49–53
 - muting 56
- opening Today screen
 - during 42
 - receiving 53–54, 58
 - restricting 79
 - sending to voicemail 53, 58, 60, 76
 - setting up conference 59–60
 - switching between 59
 - transferring to hands-free devices 71
 - troubleshooting 324, 338
 - viewing info about 55, 61, 62, 63
 - viewing missed 49
 - viewing status of 65–67
- phone headsets. *See* headsets
- Phone icon 299
- phone number codes 51
- phone numbers
 - See also* phone; phone calls
 - adding to contacts 75
 - assigning to speed dial 63–64
 - changing 78
 - copying and pasting 51, 53, 168

- entering 49–53
- getting device 25
- getting from address
 - books 122, 220
- highlighting 31
- inserting pauses in 121
- saving 57–58
- selecting 52
- phone off indicators 65, 66
- Phone Off message 48, 343
- phone on indicators 65, 66
- Phone screen 55, 56, 58
- phone settings 72–82
- Phone Settings screen 25, 75, 299
- phone specifications 359
- phone status icons 65–67
- Phone/Send button 49, 53
- phone-off icon 48
- photo albums 203
- photos. *See* pictures
- pick lists. *See* drop-down lists
- piconet 343
- picture file types 142
- picture formats 197, 202
- picture playback settings 206
- pictures
 - adding as backgrounds 205, 287
 - default resolution settings
 - for 336
 - deleting 206
 - downloading 167
 - editing 205
 - hiding on web pages 164
 - organizing 205
 - previewing 336
 - renaming 206
 - sending 143, 204
 - storing 197, 338
 - synchronizing 193–195
 - taking 197–199, 258, 336
 - viewing 202, 203, 260
- Pictures & Videos application 202–207
- Pictures & Videos icon 206
- PIM applications 341, 343
- PIMs 329, 343
- PINs 79, 80, 300, 343
- Play Slide Show command 203
- Play Sound list 304
- Play Sound options 73
- playback controls 211, 214
- playback options 213
- Playback screen 213, 214
- playing
 - media files 210
 - presentations 246, 247
 - ringtones 73
 - video clips 208
 - voice notes 233, 260
 - voicemail messages 54, 55
- playlists 208, 209, 212–213
- plug-ins 163, 288
- POP email accounts 107, 108–115
- pop-up menus 33, 34
- port numbers 311
- ports. *See* IR port; USB ports
- Power button 19, 48
- Power icon 306
- Power Save Mode 23
- Power screen 306
- PowerPoint files 235
- PowerPoint Mobile
 - application 246–247
- PowerPoint Mobile icon 246
- preferences 285
 - See also* customizing
- preinstalled applications 272
- presentation playback
 - options 246–247
- presentations 246
 - See also* PowerPoint Mobile

- Preview Mode (camera) 336
- previewing
 - pictures 336
 - ringtones 73
 - sounds 290
 - text messages 141
- prioritizing
 - email 117
 - tasks 229, 230
 - text messages 146
- private events 226
- processor 359
- Program Buttons tab 293
- Program Files folder 279
- programs. *See* applications; software
- Prompt if device unused for check box 300
- protected spreadsheets 248
- protecting
 - information 297–301
 - Treo device 297
- proxy servers 310, 311
- PUK (personal unblocking key) 344
- punctuation marks 36
- push technology 96
- Q**
- Quick Menu 40, 41, 43
- Quick Tour 13, 42
- QuickGPS feature 267
- QuickTime Player 208
- R**
- radio 48, 359
- RAS connections 309
- reassigning buttons 293–294
- Receiving Data message 276
- recent calls list 61, 62, 64
- rechargeable battery. *See* battery
- recording
 - sounds 144, 289
 - videos 199–200
 - voice notes 232, 234, 297
- recording toolbar 232
- recurring appointments. *See* repeating appointments
- recycling 2
- redialing phone 52
- redirector (websites) 335
- refreshing web pages 165, 335
- Region tab 291
- regional settings 291, 302
- Regional Settings icon 291
- Regional Settings screen 291
- registering smartphone 26
- reinstalling software or applications 315, 317
- Reject call with text message option 76
- reminders
 - creating 223, 228, 229, 231
 - system alarms and 303
 - turning on and off 289
 - viewing 66
- remote access servers 309
- Remote Desktop Mobile 281–282
- remote files 310
- Remove Programs icon 272
- Remove Programs list 273
- Remove Programs screen 272
- removing
 - See also* deleting applications 272, 338
 - attachments 144
 - battery 318
 - certificates 305
 - expansion cards 277
 - files 338
 - items from playlists 213
 - partnerships 325
 - Quick Menu 41

- Quick Tour 13, 42
 - smartphone battery 20, 317
 - renaming
 - documents 245
 - expansion cards 280
 - files 167
 - items in folders 269
 - notes 233, 261
 - pictures or videos 206
 - workbooks 257
 - worksheets 254
 - repeating appointments 224
 - repeating sounds 73, 290
 - repeating tasks 229
 - replacing
 - information 256
 - smartphone battery 318–319
 - text 242, 263
 - Request message delivery notification option 140
 - Require PIN when phone is used check box 300
 - reset button 316
 - resets 300, 316–318, 322
 - caution for 317
 - resizing
 - keyboard keys 296
 - web pages 165
 - resolution (camera) 336
 - resolution (screen) 360
 - restarting smartphone. *See* resets
 - restoring
 - backups 318, 331
 - information 317, 318
 - sound settings 288
 - restoring factory defaults 214
 - Resume playback option 214
 - reverse type 31
 - right-click menus. *See* shortcut menus
 - Ring tone command 74
 - ringer
 - adjusting volume for 74
 - silencing 53
 - turning off 74
 - Ringer switch 53, 288
 - ringtone files 72, 142
 - ringtone managers 337
 - ringtones
 - assigning to caller IDs 74
 - assigning to contacts 74, 218
 - downloading 72
 - previewing 73
 - selecting 72
 - roaming 66, 99, 330
 - Roaming option 73
 - rotating pictures 206, 207
 - running programs icon 40
- S**
- safety information 2
 - Save as Template command 145
 - Save password check box 97, 109, 111
 - Save to Contacts prompt 57
 - Save to Drafts command 117
 - Save to list 279
 - saving
 - documents 240, 241, 243, 245
 - email messages 117
 - files 167, 278
 - multimedia messages 154
 - notes 233, 234, 297
 - passwords 109, 111
 - phone numbers 57–58
 - workbooks 247, 249, 258
 - Schedule command 99
 - scheduled syncs 330, 333
 - schedules. *See* calendar
 - scheduling synchronization 98–99

- screen
 - activating items on 32
 - activating wrong features 321
 - adjusting brightness 290
 - adjusting display 290
 - aligning 292
 - caring for 17
 - changing color themes for 287, 292
 - conserving battery and 23
 - disabling touch-sensitivity for 297, 298
 - fitting web pages to 164
 - highlighting items on 29, 31–32
 - locking 56, 299
 - scrolling in 29–30, 297
 - selecting items on 30, 32
 - setting backgrounds for 205, 287
 - troubleshooting 292, 320
 - turning on or off 47, 48, 306, 341
 - waking up 48, 56
- screen fonts 290
- Screen icon 290, 292
- screen resolution 360
- screen saver 49
- screen specifications 360
- Screen view 292
- screen-locked icon 65
- screens, returning to
 - previous 30
- screensavers 207
- scroll arrows 30
- scroll bar 30
- Scroll upon reaching the last
 - line check box 297
- scrolling
 - device screen 29–30, 297
 - spreadsheets 250
 - web pages 164, 165
- SD expansion cards 276
- Search dialog box 267
- Search for list 268
- Search icon 267
- search results list 267, 268
- Search softkey 268
- searching
 - contacts 50, 218, 219, 220
 - documents 242
 - email messages 123
 - PDF files 263
 - spreadsheets 256
 - web addresses 43
 - web pages 155, 163
- searching for files 267, 269
- searching for information 267–268
- searching for signal 23
- secure networks 176
- Secure Sockets Layer (SSL) 344
- secure websites 335
- security
 - browsing websites and 163, 169, 178
 - creating passkeys and 71
 - protecting info and 297–301, 304
 - sending email and 127, 131
- security certificates 304
- security software 297
- Security tab 299
- Send Options command 146
- sending
 - copyrighted items 204
 - email 117, 124, 132, 135, 165, 333
 - meeting requests 122, 224, 228
 - multimedia messages 142, 145, 146–147, 154

- pictures 204
- sounds 289
- text messages 61, 63, 139
- videos 204
- voicemail 145
- web links 165
- sensitivity settings 226, 229
- Sent folder 127
- server information 154
- servers, troubleshooting 331, 332, 334
- service contracts 12
- service providers 12, 42, 57, 333
 - See also accounts; ISPs
- Set as Hands-Free command 325
- Set up my proxy server
 - option 310
- setting alarm clock 303
- settings. See options
- setup mode 90, 92
- sharing information 273–274
- sheet list 250
- Shift cells options 257
- Shift key 36
- Short Messaging Service.
 - See SMS messaging
- shortcut menus 33, 34
- Show half hour slots option 227
- Show list 203
- Show start and due dates option 231
- Show Tasks entry bar option 231
- Show week numbers option 227
- Side button 17
- signal, searching for 23
- signal strength 65, 321, 339
- signal-strength icon 47, 308
- signatures 125
- Signatures screen 126
- silencing system sounds 288
- silencing the ringer 53
- silent alarm 288, 290
- SIM card lock feature 298
- SIM cards 19, 21, 65, 344
- SIM Manager 221
- SIM Manager icon 25, 221
- SIM smartcards 299
- Simple PIN passwords 52, 301
- sketching 232
- skins 214
- slide show settings 207
- slide show toolbar 203
- slide shows 203, 246, 247
- slide timing option 247
- slider 30
- slides 144, 145, 149, 246
- smartcards. See SIM cards
- Smartdial softkey 58
- smartphone
 - charging 21–22, 92, 320
 - freeing space on 272, 338
 - getting help with 13
 - getting phone number for 25
 - getting started with 12, 13, 32
 - inserting batteries and 21
 - locking 300
 - losing 95, 301
 - low light conditions and 35
 - moving around on 27
 - personalizing 285
 - registering 26
 - resetting 300, 316–318, 322
 - setting up 15
 - storing 17, 18
 - troubleshoot tips for 313
 - unlocking 300
 - unpacking 11

- updating information on 85
- smartphone components 17, 18
- smartphone features 11, 13
- smartphone icon 92
- SMS messaging 139, 344
- soft resets 316
- softkeys 32
- software
 - See also* applications
 - accessing 11
 - caution for hard resets and 317
 - included with device 360
 - installing sync 85, 86, 90
 - purchasing 320
 - reinstalling 315, 317
- songs, selecting 210
 - See also* music; playlists
- Sort command 125
- sort order 255
- sorting
 - email 124
 - folder items 269
 - History list items 168
 - information 255
 - messages 151
 - pictures or videos 205
 - tasks 230
- sound clips 142
- sound settings 73, 288, 289
- sounds
 - See also* specific types
 - changing alarm 304
 - customizing 288
 - previewing 290
 - recording 144, 289
 - repeating 73
 - sending 289
 - setting system 289
 - silencing 288
 - turning off event 290
- Sounds & Notifications screen 72, 289
- Sounds & Notifications Settings icon 289
- Sounds tab 289
- speaker 208
- speakerphone 56, 339
- speakerphone icon 65
- special characters. *See* alternate characters; symbols
- specifications 359
- speed dial 50, 63–64
- Speed Dial command 64
- spell-checking 117, 140, 244
- spreadsheet templates 247, 249, 258
- spreadsheet toolbar 250
- spreadsheets
 - See also* Excel Mobile; workbooks; worksheets
 - accessing 235
 - adding charts to 255, 256
 - calculations in 250–252
 - changing order of worksheets 253
 - creating 247
 - customizing filters for 255
 - deleting elements in 257
 - display options for 249–250
 - entering data in 249, 252
 - formatting 247, 253–254
 - insertion options for 252
 - scrolling 250
 - searching 256
 - sorting in 255
- Sprite Backup application 95
- SSL protocol 344
- Start button 39
- Start menu 39, 292
- starting
 - data connections 310

- Excel Mobile 249
- Internet Explorer Mobile 163
- PowerPoint Mobile 246
- Quick Tour 13
- synchronization 86, 93, 94
- Word Mobile 241
- stereo headphones 208
- stopping playback 210
- stopping synchronization 103
- Storage Card folder 280
- storage card symbol 269
- Storage Card tab 306
- storage cards. *See* expansion cards
- storage space 305, 331
- storing
 - applications 338
 - document files 241, 243, 245, 257
 - information 276, 338
 - media files 211
 - pictures 197
 - smartphone 17, 18
 - videos 199
 - workbooks 257
- streaming 170–172, 211, 344
- Streaming Media icon 170
- Strong alphanumeric passwords 52, 301
- stylus 29, 31
- submenus 33
- Suggest words when entering text option 296
- support 13
- symbols 36, 37, 251
- sync applications 85, 93
- sync conflicts 98
- sync errors 195
- sync methods 88
- sync mode 92
- sync options 85, 102
- sync schedules 98, 330, 333
- sync settings (Exchange servers) 98
- sync software 12, 85, 86, 88, 90, 315
- sync software window 93
- synchronization
 - backing up information and 317
 - connecting to PCs and 12
 - conserving battery and 24
 - defined 344
 - enabling wireless 86, 95–100, 101
 - getting started with 26
 - hard resets and 317, 318
 - initiating manual 99
 - initiating over Bluetooth devices 100–101
 - overview 83, 85
 - scheduling 98–99
 - sending meeting requests and 225
 - setting up multiple computers for 101
 - starting 86, 93, 94
 - stopping 103
 - transferring media files and 193–195, 208
 - transferring Office files and 237–239
 - troubleshooting 316, 325–332, 334
- synchronization in-progress icons 66
- synchronizing
 - addresses 329
 - dates and time 303
 - folders 133
 - offline 329
 - subfolders 133
 - through USB hubs 328
 - wirelessly 331

- with third-party applications 317
- system alarms 303
- System Center Mobile Device Manager 312
- system dates and time 302
- system errors 322
- system locks 298, 300
- system messages 81
- system requirements 89
- system settings 302–308
- system sounds 288, 289
- system warnings 289

T

- tabs 30
- taking pictures 197–199, 258, 336
- tapping 29, 32, 292, 296
- tapping sounds 289
- task categories 229, 230
- Task Manager 40
- task settings 230–231
- tasks
 - adding reminders to 229
 - completing 230
 - creating 228–230
 - deleting 230
 - filtering and sorting 230
 - marking as sensitive 229
 - sending 144
 - setting due dates for 229
 - setting reminders for 231
- Tasks application 228–231
- Tasks entry bar 230, 231
- Tasks icon 228
- Tasks list 230
- Tasks Over The Air (OTA) 96
- Tasks tab (Connections) 309, 310
- TDD devices. *See* TTY/TDD devices
- technical support 13
- telecommunications devices 74
- templates
 - documents 241, 245
 - messages 145
 - notes 233, 234
 - spreadsheets 247, 249, 258
- Templates folder 241, 249
- tentative appointments 223
- text
 - aligning 244
 - changing 242
 - copying 168
 - creating documents and 240
 - deleting 32, 50
 - entering 36, 296, 297
 - finding and replacing 242, 263, 296
 - formatting 243, 259
 - highlighting 31, 32, 243
 - moving or copying 242
 - resizing 290
 - spell-checking 117, 140, 244
- text captions 143
- text files 305
- Text Layout command 145
- text message services 78
- text messages
 - checking for 65
 - converting to multimedia 140
 - creating 139–141
 - deleting 147, 152
 - displaying 43, 49
 - forwarding 149
 - making phone calls and 52, 147
 - opening 148
 - previewing 141
 - receiving 139, 147, 324
 - replying to 147, 148, 149
 - selecting links in 150

- sending 61, 63, 139
- setting preferences for 152
- sorting 151
- troubleshooting 324
- text phrases 116, 140, 143
- Text Size tab 290
- text telephone devices. *See* TTY/TDD devices
- text-entry fields. *See* entry fields
- themes 287, 292
- third-party applications
 - 5-way navigator and 29, 338
 - accessing Outlook folders and 329
 - caution for hard resets and 317
 - deleting 338
 - getting help with 337
 - installing 269, 270, 337, 338
 - previewing pictures and 336
 - reinstalling 315, 317
 - synchronizing with 87, 317
- troubleshooting 270, 320, 337–338
- time format settings 292
- time stamps 200
- time system settings 302
- Time tab 302
- time zones 302
- tips 11
- TKIP encryption 178
- Today screen
 - accessing 42
 - changing color themes for 292
 - connecting to Bluetooth devices from 185
 - customizing 205, 287
 - dialing from 49
 - recovering settings for 331
 - removing Quick Menu from 41
 - removing Quick Tour from 13, 42
 - selecting running apps from 40
 - starting web searches from 163
 - viewing info on 42–43
- viewing voicemail messages on 54
- touchscreen. *See* screen
- touchscreen lockout 297, 299
- touch-sensitive feature 297
- transactions 335
- transition effects (slides) 247
- transmission delays 324
- Transparency level list 205
- travel information 172
- troubleshooting 13, 313
- trusted device list 184, 185
- trusted devices 184, 186
 - See also* partnerships
- trusted pairs. *See* partnerships
- TTY icon 75
- TTY/TDD devices 74–75
- TTY/TDD mode 74
- Turn Hands-free Off
 - command 71
- Turn Hands-free On
 - command 71
- turning on or off
 - alarms 289, 303
 - event sounds 290
 - reminders 289
 - screen 306

Typing mode 234

U

UDP ports 172

UMTS networks 57

UMTS services 345

UMTS status icons 66, 67

unauthorized users 297, 304

unavailable time slots 226

Unhold option 56

Unicode language settings
153

Unknown Caller option 73

unlocking

 SIM smartcards 299, 300

 smartphone 300

 spreadsheet rows and
 columns 250

unread messages 43, 49,
148

unretrieved voicemail 54

untimed events 224

Update Library command
212

updating information 85

uppercase letters 36, 297

URLs 127, 246

See also web links

USB AC charger 21

USB cable 22, 91, 94

USB controllers 329

USB hubs 91, 328

USB ports 91, 328

Use network time zone

 check box 303

User Guide 12, 26

usernames 345

V

vCal attachments 334

vCalendar attachments 144,
228

vCard attachments 144, 334

Vibrate when... check boxes
73, 290

vibrating alarm 288, 290

video albums 203

video files 142, 203, 330

video icon 199

video ringtones 195

video settings 199, 214

videos

 deleting 206

 downloading 208

 organizing 205

 playing 208

 recording 199–200

 renaming 206

 sending 143, 204

 setting resolution for 336

 storing 199

 synchronizing 193–195

 transferring to expansion
 cards 208

 viewing 203

View All Calls command 62,
63

viewing

 alternate characters 37

 animated images 208

 application menus 32, 33,
34

 appointments 43, 222,
223

 calendar 222

 contact info 141, 149, 220

 current connection 310

 events 224, 226

 folder contents 268

 memory usage 305

 notifications 290

 on-device help 13

 PDF documents 261

 pictures 202, 203, 260

 power settings 306

 service provider 42

 space on expansion cards
 280, 306

 speed dial numbers 64

- tasks 230, 231
- unread messages 43, 49
- videos 203
- voicemail messages 54
- web favorites 166
- web pages 163, 164, 165
- wireless settings 307
- virtual private networks. *See* VPN connections
- Vista operating systems. *See* Windows Vista computers
- voice calls 65
- voice captions 144
- Voice Command application 294–295
- Voice Command button 295
- Voice Command icon 294, 319
- Voice Command settings 319
- voice commands 24, 295
- Voice mail option 73
- voice notes 232–233, 234, 297
- Voice recording format list 297
- voice recording formats 297
- voicemail
 - changing phone number
 - for 78–79
 - checking for 65
 - listening to 54–55
 - sending 145
 - sending calls to 53, 58, 60, 76
 - voicemail icon 54
 - voicemail notifications 55
 - Voicemail softkey 55
 - volume
 - phone 74
 - ringer 74
 - tapping sounds 289
 - VPN clients 325
 - VPN connections 310
- W**
- waking up smartphone screen 48, 56
- wallpaper 195
- warnings 289
- warranty 11
- weak signals 321, 339
- web addresses 43, 164, 335
 - See also* web links
- web browsers 163
 - See also* Internet Explorer Mobile
- web browsing
 - getting started with 163, 165
 - memory consumption and 338
 - secure sites and 163, 164, 169, 335
 - troubleshooting 335
 - wireless connections and 161, 174
- web favorites. *See* favorites
- web files 169
- web forms 165
- web links
 - creating 260
 - highlighting 31
 - internal memory and 338
 - selecting 127, 165, 260
 - sending 165
 - troubleshooting 335
- web navigation features 29
- web pages
 - accessing 335
 - adding to favorites 166
 - arranging on screen 164
 - clearing links to 338
 - copying from 168
 - dialing from 52, 168
 - downloading items from 167, 271

- hiding images on 164
- moving around in 165
- opening 163, 166, 168
- playing media files from 211
- refreshing 165, 335
- resizing 165
- returning to recently viewed 168
- scrolling 164, 165
- searching 155, 163
- selecting addresses on 335
- sending email from 165
- setting as home 165, 168
- synchronizing favorites for 87
 - viewing 163, 164, 165
- web-based email 108, 155
- websites
 - See also* web browsing
 - accessing 161, 174, 187
 - connecting to 163
 - ending connections to 311
 - redirectors and 335
 - searching over 155, 163
 - streaming from 170–172, 211
 - submitting transactions and 335
- Week View 222, 227
- WEP encryption 178
- Wi-Fi button 175
- Wi-Fi feature
 - turning on or off 18, 23, 175
 - viewing status of 42, 66
- Wi-Fi networks 174–179
- Wi-Fi settings 179–183
- Windows Live Mail 156–158
- Windows Live Messenger 158–159
- Windows Live services 155, 204
- Windows Mobile Device Center 85, 94, 345
- Windows Mobile devices 90, 274, 315
- Windows Mobile operating system 320, 345
- Windows Mobile software 270
- Windows Update application 308
- Windows Vista computers
 - enabling Bluetooth connections for 100
 - opening sync application for 94
 - synchronizing with 85, 95
- Windows XP computers
 - enabling Bluetooth connections for 100
 - enabling phone as modem and 187
 - opening ActiveSync for 93
 - synchronizing with 85, 95, 193, 194
- wired headsets 68, 71
- wireless band setting 80
- wireless connection icons 66
- wireless connections
 - browsing websites and 161, 174
 - conserving battery and 18
 - ending 179
 - synchronizing and. *See* wireless synchronization
 - turning on 175
- wireless features 308, 337
- wireless modems 187
- wireless service indicator 42
- wireless service providers 12, 42, 57
- wireless services 307

- wireless synchronization 86, 95–100, 101, 331
 - Word application 235
 - See also documents
 - Word Completion tab 296
 - word highlight feature 32
 - Word Mobile application 30, 239–245
 - Word Mobile icon 241
 - word-processing features 240
 - workbook list 258
 - workbooks
 - See also Excel Mobile application; spreadsheets
 - creating 249
 - deleting 258
 - displaying 249–250
 - moving around in 250
 - naming 257
 - organizing 257
 - replacing information in 256
 - saving 247, 249, 258
 - searching 256
 - setting default template for 258
 - worksheet names 248
 - worksheets
 - See also spreadsheets; workbooks
 - adding 253
 - adjusting column and row size for 254
 - deleting 258
 - entering defined names in 254
 - entering formulas in 251, 258
 - entering functions in 251
 - filtering data in 255
 - formatting options for 253–254
 - inserting cells, rows, and columns 252
 - moving between 250
 - naming 253
 - removing cells, rows, and columns 257
 - renaming 254
 - WorldMate 172, 173
 - WPA networks 178
 - Writing mode 234
- Y**
- Year View 222
- Z**
- ZIP files 270
 - zoom settings
 - documents 241
 - pictures 260
 - presentations 246
 - smartphone screen 297
 - spreadsheets 248, 250
 - web pages 165

Palm, Inc.
950 W. Maude Ave.
Sunnyvale, CA 94085-2801
United States of America

PN: 406-11437-00